



# TREAT 100

*CONDITIONS WITH SUPPLEMENT*

Dr. Mahmoud Sous

Priyanka Yadav



# *TREAT 100 CONDITIONS WITH SUPPLEMENT*

A complete care guide To Supplements Treatments

Dr. Mahmoud Sous  
Priyanka Yadav

Copyright © 2022 by Dr. Mahmoud Sous.

All rights reserved. No part of this book may be reproduced in any form or by any electronic or mechanical means, including information storage and retrieval systems, without permission in writing from the publisher, except by reviewers, who may quote brief passages in a review.

This publication contains the opinions and ideas of its author. It is intended to provide helpful and informative material on the subjects addressed in the publication. The author and publisher specifically disclaim all responsibility for any liability, loss, or risk, personal or otherwise, which is incurred as a consequence, directly or indirectly, of the use and application of any of the contents of this book.

**Website:** [www.drsous.ca](http://www.drsous.ca)

**Email:** [mahmoudsous@yahoo.com](mailto:mahmoudsous@yahoo.com)

ISBN 978-1-998900-26-8



## **Dr. Mahmoud Sous – Ph.D.**

During the period of 1995-1999, I went to the medical school in Poland to research about the various methods of back pain treatment. After finishing my PhD, I took variety of courses including naturopath, acupuncture, and manual techniques. This gave me an idea that exercises, and massage could be helpful in treatment of chronic pain. But my findings didn't stop me here, I also worked as a naturopath practitioner in Canada where I got familiar about treatments with Chinese medicines, osteopath techniques and some other manual therapies which helps in pain management.

Fixing injuries requires an understanding of anatomy and biomechanics. That is why my research and treatment belong to the holistic approach of using different techniques and remedies for the treatment of back pain. In 1990, I realize that there are some complex spinal aspects and issues which leads to of back pain. So, from my case studies I formulated a guideline which is clear and easy to understand and will fix your issues.

My goal is to help people visualize how the body functions and what happens inside when you experience pain. Healing requires to focus on one's action because pain results due to faulty actions and movements. This thought motivated me to work on a book which will include all home remedies where people can treat themselves to fix their pain. I have included knowledge based on my clinical research using manual massage therapy, food habits, nutrition facts, heat, sauna, hydrotherapy, cold water treatments which overall helps in pain management. It gives me pleasure to introduce this book to the community where I have shared all my experienced treatment plans.



### **Priyanka Yadav (Physiotherapist)**

I started my career in 2011, since then I have worked as a Physiotherapist in several clinics and hospitals in India. Working mostly in the Outpatient department made me realize that Physio's role is extremely crucial in the rehabilitation and recovery process of a patient. My desire to reach out to more people motivated me to work for this book. Have worked with Dr. Mahmoud on several research books on self-pain management. We have been constantly working on curating the best suited protocol for various Musculoskeletal conditions. Additionally, we have also included approaches with alternative medicine.

**We Believe in a Pain-Free Society!**

**Dr. Sous's Team who have contributed with their approaches in this book.**

- \* Priyanka Yadav - Physiotherapist / Massage Therapist
- \* Mandeep Kaur - Physiotherapist
- \* Youssef Elaridi - RMT
- \* Haitham Ajoury - Layout & Design

This is a self-help book written by Mahmoud Sous PhD, DO and team. It is the result of more than 16 years of musculoskeletal experience practicing in corporate and private physiotherapy clinics around the world. This book was created to help you get to know your shoulders better and is based on more holistic approach to treat and prevent shoulder injuries and pain. Shoulder pain is very common, and although shoulder pain can be alarming, serious, or permanent damage to the shoulder is uncommon. This book will help explain how the shoulder is put together and why shoulder pain and dysfunctions occur, enable you with ways of coping with pain.

**We believe in a Pain-Free Society!**

# ABOUT THE BOOK

For the past two decades, Prof. Sous has immersed himself in the captivating realm of health and wellness. Together with his dedicated team, they have embarked on a literary journey, crafting insightful books that delve into the art of nurturing your body through natural means. The team has been researching about the benefits of herbal supplements, using them in practice, and collecting research data regarding the usage, indications, contraindications, and its natural source.

This exceptional compendium stands as a comprehensive reference guide for addressing the most prevalent health concerns of our modern world. Inside its pages, you will discover a wealth of knowledge on how to tackle these issues, with the power of dietary supplements, herbs, and medicinal mushrooms. Empower yourself to take charge of your well-being using these proven dietary methods, capable of preventing or alleviating a wide range of health challenges. Within this handbook, you will uncover the remarkable advantages of dietary supplements and herbs, supported by the very latest findings, all presented in a valuable resource that unveils natural remedies for over 100 common ailments.

Drawing from Prof. Sous's extensive clinical experience and the latest research, The Supplement Handbook serves as your trusted companion, guiding you through the maze of treatment options for more than 100 prevalent conditions. From arthritis, diabetes, and high cholesterol to fibromyalgia, migraines, and even Alzheimer's Disease, this essential guide provides clarity amidst conflicting information, offering definitive answers to help you manage your condition without any harmful side effects. Beyond a mere overview, The Supplement Handbook delivers actionable advice, providing a reliable compass for your journey. Whether you are an ardent believer in alternative medicine or a curious newcomer to the world of supplements, this comprehensive, evidence-based guide is destined to become an indispensable reference in your home.

This highly readable and reliable guide will tell you what natural medicines have proven to be both safe and effective while suggesting the "Top Picks" for health issues such as:

- Brain and Heart Health
- Digestive and Immune health
- Diabetes & Pancreas Problems
- Losing weight
- Respiratory health
- Musculoskeletal Conditions
- Prostate & Testosterone

You'll also find easy-to-understand information of the symptoms and root causes of each health problem along with a proven, natural most recommended supplement. Also contains the latest information on vitamins, minerals, phytonutrients, and more with suggestions for safe & effective usage.





# Contents

Chapter No.	Title	PageNo.
	Introduction	
<b>1</b>	<b>CHAPTER I. Musculoskeletal System .....</b>	<b>1</b>
	Disc Herniation.....	1
	Arthritis.....	3
	Osteoporosis.....	5
	Gout.....	8
	Heel Spur.....	10
	Sciatica, Piriformis Syndrome .....	12
	Tendonitis (Golfers Elbow, Tennis Elbow).....	14
	Adhesive Capsulitis (Frozen Shoulder).....	17
	Lower Back Pain.....	19
	Rotator Cuff Injuries .....	22
	Planter Fasciitis.....	25
<b>2</b>	<b>CHAPTER II. Head &amp; Spinal Cord.....</b>	<b>28</b>
	Sleeping issues.....	28
	Brain Fog .....	31
	Improve Memory & Focus .....	33
	Dementia .....	36
	Alzheimer's disease .....	39
	Parkinson's' disease .....	42
	Stroke .....	45
	Paresthesia, Numbness, Tingling.....	48
	Cold Hands .....	51
	Carpal Tunnel .....	53
	Thoracic Outlet Syndrome (TOS).....	55
<b>3</b>	<b>III. Blood, Heart &amp; Cholesterol .....</b>	<b>58</b>
	High Blood Pressure .....	58
	Low Blood Pressure .....	61
	High Cholesterol .....	64
	Atherosclerosis.....	67
	Coronary Artery Disease .....	70
	Irregular heartbeats (arrhythmias).....	73
	Congenital Heart Defects .....	76
	Deep Vein Thrombosis (DVT).....	79
	Anemia .....	83
	Blood Clots .....	85
	Hemophilia .....	88
<b>4</b>	<b>CHAPTER IV. Systemic Condition related to Kidneys, Liver &amp; Gall Bladder .....</b>	<b>91</b>
	Kidney stone .....	91
	Chronic Kidney Disease.....	94
	Kidney Infection .....	97
	Polycystic Kidney .....	100
	Inflammation of the Liver.....	103
	Fatty Liver Disease .....	106
	Cirrhosis .....	109
	Gallstone .....	112
	Gall Bladder Infection (Cholecystitis).....	115
<b>5</b>	<b>CHAPTER V. Prostate &amp; Testosterone Conditions .....</b>	<b>118</b>
	Low Testosterone levels/ Hypogonadism.....	118
	Enlarged Prostate .....	121
	Prostate Cancer .....	124
	Faster Erection/ Premature ejaculation.....	127

Chapter No.	Title	PageNo.
	Prostatitis (Inflammaion).....	131
	Erectile Dysfunction .....	134
	Hypogonadism .....	136
	Varicocele .....	140
	Epididymitis .....	143
<b>6</b>	<b>CHAPTER VI. Diabetes, Pancreas &amp; Weight loss .....</b>	<b>146</b>
	Type 1 Diabetes.....	146
	Type 2 Diabetes .....	150
	Gestational Diabetes .....	154
	Diabetic Foot.....	157
	Diabetic Retinopathy.....	161
	Acute and Chronic Pancreatitis .....	164
	Pancreatic Cysts .....	168
	Pancreatic enzyme deficiency disorder .....	171
	To improve Pancreas Function .....	175
	Obesity/ Weight Loss .....	178
<b>7</b>	<b>CHAPTER VII. Immune System .....</b>	<b>182</b>
	Fibromyalgia .....	183
	Multiple Sclerosis .....	186
	Myasthenia Gravis .....	189
	Pernicious Anemia .....	192
	Reactive Arthritis .....	195
	Rheumatoid Arthritis .....	198
	Celiac Disease .....	201
	Systemic Lupus Erythematosus .....	204
	To improve Immunity .....	208
	Graves Disease .....	211
	Hashimoto's Thyroiditis .....	214
	Inflammatory Bowel Disease .....	216
<b>8</b>	<b>CHAPTER VIII. Digestive System Problems .....</b>	<b>220</b>
	Crohn's Disease .....	220
	High Helicobacter Bacteria .....	224
	Irritable Bowel Syndrome .....	225
	Bladder Infection .....	229
	Urinary Tract Infection .....	233
	Hemorrhoids .....	237
	Cold Bladder .....	240
	Constipation .....	243
	Diarrhea .....	246
	GERD (Gastroesophageal Reflux Disease) .....	249
<b>9</b>	<b>CHAPTER IX. Respiratory Condition .....</b>	<b>253</b>
	Asthma .....	254
	COPD (Chronic Obstructive Pulmonary Disease) .....	257
	Cystic Fibrosis .....	260
	Pneumonia .....	263
	Tuberculosis .....	265
	Breathing issue .....	269
	Emphysema .....	271
	Bronchitis.....	274
	Sinusitis .....	276
	Common Cold .....	279
	Allergies.....	283

# TREAT 100 CONDITIONS WITH SUPPLEMENTS

## CHAPTER I. MUSCULOSKELETAL SYSTEM

The musculoskeletal system is a complex network of bones, muscles, ligaments, tendons, and joints that work together to provide structure, stability, and movement to the human body. It serves as the framework upon which our bodies are built, allowing us to stand upright, walk, run, jump, and perform various physical activities. The bones in our body not only provide support but also protect vital organs, produce blood cells, and store minerals like calcium. The muscles, on the other hand, enable movement by contracting and relaxing, allowing us to perform voluntary actions like lifting objects, waving our hands, or even smiling. The ligaments and tendons play crucial roles in connecting bones to bones and muscles to bones respectively, ensuring stability and transmitting the force generated by the muscles to produce movement. Joints, such as the hinge joint of the knee or the ball-and-socket joint of the hip, allow for smooth and controlled movements by providing flexibility and reducing friction between bones. The musculoskeletal system is not just limited to our ability to move; it also has a significant impact on our overall health and well-being. Regular exercise and physical activity help maintain the strength and integrity of our bones, overall quality of life. In conclusion, the muscles, and joints, reducing the risk of injuries and conditions like osteoporosis or arthritis. Additionally, a healthy musculoskeletal system contributes to good posture, balance, and coordination, improving musculoskeletal system is a remarkable and intricate system that allows us to perform a wide range of physical movements and activities, and it is essential to take care of it through proper exercise, nutrition, and overall self-care.

### 1) DISC HERNIATION

A herniated disc (also called bulged, slipped or ruptured) is a fragment of the disc nucleus that is pushed out of the annulus, into the spinal canal through a tear or rupture in the annulus. Discs that become herniated usually are in an early stage of degeneration.

#### # Symptoms

Pain that occurs on one side of the body.

Sharp pain in one part of the leg, hip, or buttocks and numbness in other parts. You may also feel pain or numbness on the back of the calf or sole of the foot. ...

Pain when moving your neck or deep pain near or over the shoulder blade.

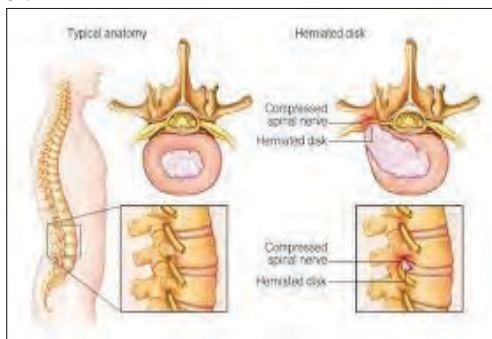

**The recommended supplement for Disc Herniation:** Vitamin D3, Platinum Turmeric, & Joint Support Gummies

#### 1. Vitamin D3

Vitamin D3 is a fat-soluble vitamin that supports the growth and development of bones and teeth. It also plays an essential role in the functioning of the muscles and boosting energy levels in the body. The body naturally produces Vitamin D when exposed to sunlight, and you can also receive Vitamin D from some foods like oily fish. In the winter months, especially in colder regions, the body doesn't produce as much Vitamin D, which can lead to what's called 'seasonal depression.'

**Ingredients:** see Supplement Facts.

**Manufacturer Country:** USA

**Product Amount:** 100 soft-gels

**Gross Weight:** 0.1lb (45g)

**Suggested Use:** As a dietary supplement, adults take one (1) soft-gel capsule daily or as directed by a health care professional. Store in a cool, dry place and away from direct light.



## 2. Platinum Turmeric

Our Platinum Turmeric blend contains various forms of turmeric, glucosamine, Boswellia extract (frankincense), piperine, and several other highly beneficial natural extracts to keep you at your best. The unique formulation of Dr. Sous Platinum Turmeric combines the powerful anti-inflammatory properties of turmeric with other key ingredients that have been shown to support bone health. Turmeric, known for its active compound curcumin, has long been recognized for its anti-inflammatory and antioxidant properties. These properties can play a crucial role in reducing inflammation and oxidative stress, which are both key contributors to bone loss and osteoporosis. Additionally, Dr. Sous Platinum Turmeric incorporates other essential nutrients, such as glucosamine, piperine, Boswellia extract (frankincense), and several other extremely advantageous natural extracts. Black pepper's main element, piperine, has been demonstrated to block a process in your body that removes compounds like curcuminoids, promoting improved absorption.

In Ayurveda medicine, natural extracts have been utilised to treat ailments for millennia. Supplements with a lot more efficacy than turmeric can be made by extracting the curcumin and curcuminoids from turmeric. But because curcumin absorbs poorly through digestion, a wide range of formulations have been developed to increase its bioavailability. For maximum bioavailability and efficacy, we modernise and harness these natural extracts.

**Ingredients:** see Supplement Facts.

**Manufacturer Country:** USA

**Product Amount:** 60 caps

**Net Weight:** 0.25lb (113g)

**Suggested Use:** Take two (2) capsules once a day as a dietary supplement. For best results, take 20-30 min before a meal or as directed by your healthcare professional.



## 3. Joint Support Gummies

Joint Support Gummies are a delicious way to get in the necessary level of glucosamine that your body needs to replenish cartilage and tendon tissues around the joints while also increasing the fluid around joints to prevent their breakdown.

As the body ages, joints start to ache because of the breakdown of cartilage around the joint. For some, this creates severe discomfort. Cartilage breakdown is more apparent in athletes who push their bodies to the limit. Joint Support Gummies are a delicious way to counteract this.

**Ingredients:** see Supplement facts.

**Flavor:** Raspberry

**Manufacturer Country:** USA

**Product Amount:** 60 gummies

**Gross Weight:** 0.56lb (255g)

**Suggested Use:** Take two (2) gummies once a day as a dietary supplement.

**DRSOUS.CA Joint Support Gummies (Adult)**  
Regular price: \$24.40 CAD  
Product Amount: 60 gummies  
Gross Weight: 0.56lb (255g)  
Joint Support Gummies were made to support athletes through rigorous exercises, to get the necessary level of glucosamine that your body needs to replenish cartilage and tendon issues.

- Good for arthritis and joint pain
- Aids in athletic performance
- Aids in tissue growth around joints

**Supplement Facts**  
Serving Size: 2 Gummies  
Servings Per Container: 30

	Amount Per Serving	% Daily Value*
Glucosamine	150 mg	—
Chondroitin Sulfate	50 mg	—
MSM (Methyl Sulfonyl Methane)	100 mg	—
Collagen Type II	50 mg	—
MSM (Methyl Sulfonyl Methane)	100 mg	—
MSM (Methyl Sulfonyl Methane)	100 mg	—
MSM (Methyl Sulfonyl Methane)	100 mg	—
MSM (Methyl Sulfonyl Methane)	100 mg	—
MSM (Methyl Sulfonyl Methane)	100 mg	—
MSM (Methyl Sulfonyl Methane)	100 mg	—

\*Percent Daily Values are based on a diet of other people's secrets.

Parasitic Wellness  
A specific channel for Joint support on YouTube

Dr. Sous  
www.drsous.ca

## 2) ARTHRITIS

Arthritis means inflammation or swelling of one or more joints. It describes more than 100 conditions that affect the joints, tissues around the joint, and other connective tissues. Specific symptoms vary depending on the type of arthritis, but usually include joint pain and stiffness.

### # Symptoms

The most common signs and symptoms of arthritis involve the joints. Depending on the type of arthritis, signs and symptoms may include:

- Pain
- Stiffness
- Swelling
- Redness
- Decreased range of motion

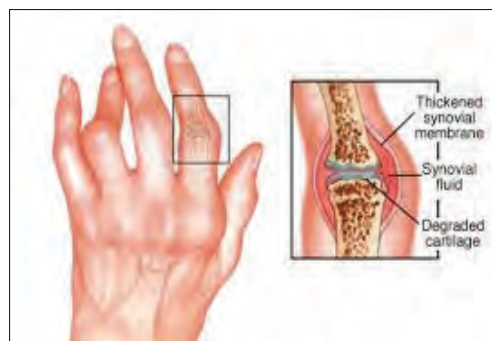
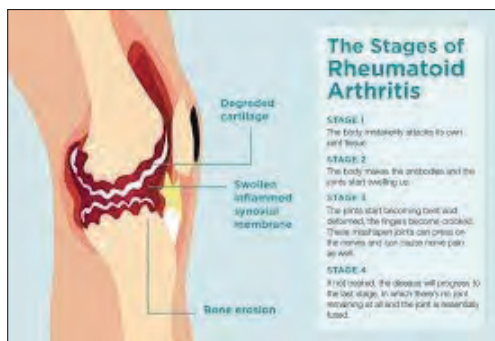

**The recommended supplement for Arthritis are:** Collagen Peptides, Joint Support Gummies, Platinum Turmeric



### 3. Platinum Turmeric

Turmeric contains a compound called curcumin, which possesses anti-inflammatory and antioxidant properties. These properties make turmeric a potential natural remedy for arthritis symptoms. Studies have suggested that curcumin may help reduce joint pain, swelling, and stiffness in individuals with arthritis. It is believed that curcumin inhibits certain inflammatory enzymes and mediators, thereby reducing the inflammatory response in the joints. Additionally, curcumin's antioxidant properties help protect the joints from oxidative stress, which is known to contribute to arthritis progression. While research is still ongoing, and more extensive clinical trials are needed to establish the exact mechanisms and efficacy of turmeric supplements for arthritis, preliminary findings are promising. However, it is important to note that the bioavailability of curcumin is relatively low, meaning that the body may not absorb it efficiently. To enhance absorption, it is often recommended to consume turmeric with black pepper, which contains a compound called piperine that can improve curcumin's bioavailability. Piperine, has been demonstrated to block a process in your body that removes compounds like curcuminoids, promoting improved absorption. Our platinum turmeric blend contains glucosamine, Boswellia extract (frankincense), piperine, and several other highly beneficial natural extracts to keep you at your best.

Natural extracts have been used for centuries in Ayurvedic medicine to remedy illnesses. We harness and advance these natural extracts in modern times for optimal bioavailability and effectiveness.

**Ingredients:** see Supplement Facts.

**Manufacturer Country:** USA

**Product Amount:** 60 caps

**Gross Weight:** 0.25lb (113g)

**Suggested Use:** Take two (2) capsules once a day as a dietary supplement. For best results, take 20-30 min before a meal or as directed by your healthcare professional.



### 3) OSTEOPOROSIS

Osteoporosis weakens bones to the point that they can break easily. It is called a “silent disease” because people who develop it may not notice any changes until a bone breaks — usually a bone in the hip, spine, or wrist. Bones are made of living tissue.

#### # Symptoms

5 Alarming Symptoms of Osteoporosis -

1. Receding Gums.
2. Brittle Fingernails.
3. Easy Fractures.
4. Back and Neck Pain.
5. Curved or Stooped Spine.

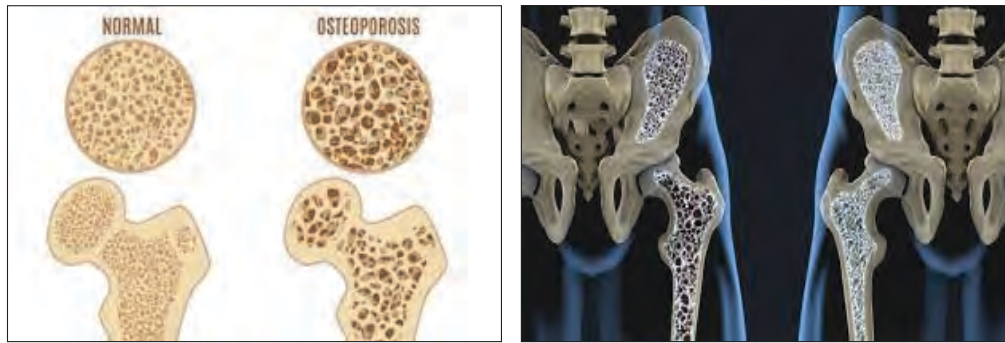

**The recommended supplement for Osteoporosis:** Vitamin D3, Magnesium Glycinate, Bone & Heart Support

### 1. Vitamin D3

Vitamin D3 is a fat-soluble vitamin that supports the growth and development of bones and teeth. It also plays an essential role in the functioning of the muscles and boosting energy levels in the body.

Vitamin D3 plays a crucial role in maintaining bone health and preventing osteoporosis. Osteoporosis is a condition characterized by weak and brittle bones, making individuals more prone to fractures and injuries. Vitamin D3, also known as cholecalciferol, is a fat-soluble vitamin that can be synthesized by the body when exposed to sunlight. It is also found in certain foods such as fatty fish, fortified dairy products, and egg yolks. Vitamin D3 is essential for the absorption and utilization of calcium, a mineral that is vital for building and maintaining strong bones. When there is a deficiency of vitamin D3, the body is unable to efficiently absorb calcium from the diet, leading to a decrease in bone density and an increased risk of osteoporosis. Therefore, supplementation with vitamin D3 is often recommended for individuals at risk of or diagnosed with osteoporosis. Vitamin D3 supplements can help improve bone mineral density, reduce the risk of fractures, and enhance muscle strength, all of which are important for maintaining overall bone health. Additionally, vitamin D3 has been shown to have anti-inflammatory properties, which can help reduce pain and inflammation associated with osteoporosis.

**Ingredients:** see Supplement Facts.

**Manufacturer Country:** USA

**Product Amount:** 100 soft-gels

**Gross Weight:** 0.1lb (45g)

**Suggested Use:** As a dietary supplement, adults take one (1) soft gel capsule daily or as directed by a health care professional. Store in a cool, dry place and away from direct light.

**DRSOUS.CA Vitamin D3 helps maintain bone density, strength and healthy cell growth**

Vitamin D3 is a fat-soluble vitamin that supports the growth and development of bones and teeth. It also plays an essential role in the functioning of the muscles and boosting energy levels in the body. The body naturally produces Vitamin D when exposed to sunlight, and you can also receive Vitamin D from some foods like oily fish. In the winter months, especially in colder regions, the body doesn't produce as much Vitamin D, which can lead to what's called 'seasonal depression.'

154

www.pure4lifevitamins.ca

A specific channel for Supplements on YouTube

Dr. SOUS | www.drsous.ca



## 2. Magnesium Glycinate

Magnesium Glycinate is one of the most important nutrients needed throughout the body. Magnesium glycinate is a popular supplement that is often recommended for individuals suffering from osteoporosis. Osteoporosis is a condition characterized by weakened bones, making them more prone to fractures and breaks. Magnesium is a vital mineral that plays a crucial role in bone health and overall bone density. It is involved in the regulation of calcium balance in the body, which is essential for maintaining strong bones. By supplementing with magnesium glycinate, individuals with osteoporosis can potentially improve their bone health and reduce the risk of fractures. Magnesium glycinate is a highly bioavailable form of magnesium, meaning that it is easily absorbed by the body and readily utilized. This makes it an excellent choice for individuals with osteoporosis as it ensures maximum effectiveness. Additionally, magnesium glycinate has been found to have a calming effect on the nervous system, which can be beneficial for those suffering from osteoporosis-related pain or discomfort. It may also help improve sleep quality, which is essential for overall health and well-being.



## 3. Bone & Heart Support

Both vitamins D3 and K2 are essential to the body's function and overall health. Vitamin D3 aids in the absorption of calcium and phosphorus, which are essential for bone formation and maintenance.

In addition to supporting the development of strong bones, Vitamin K2 may also benefit the cardiovascular system since it may promote healthy blood clotting.

**Ingredients:** see Supplement Facts.

**Manufacturer Country:** USA

**Product Amount:** 60 caps

**Gross Weight:** 0.25lb (113g)

**Suggested Use:** Take one (1) capsule twice a day as a dietary supplement. For best results, take 20-30 min before a meal or as directed by your healthcare professional.

**Caution:** Do not exceed recommended dose. Pregnant or nursing mothers, children under the age of 18, and individuals with a known medical condition should consult a physician before using this or any dietary supplement.

	Amount Per Serving	%DV
Calcium (as Calcium Citrate)	210 mg	100%
Vitamin D3 (Cholecalciferol)	125 mcg	625%
Vitamin K2 (as Menaquinone-7)	100 mcg	1
Calcium:K2 Ratio	3 mg	1

† Daily Value (DV) not established.

Other Ingredients: Cellulose (vegetable capsule).

#### 4) GOUT

Gout is a type of arthritis in which small crystals form inside and around the joints. It causes sudden attacks of severe pain and swelling. It's estimated that between one and two in every 100 people in the UK are affected by gout. The condition mainly affects men over 30 and women after menopause.

##### # Symptoms

The signs and symptoms of gout almost always occur suddenly, and often at night. They include:

**Intense joint pain.** Gout usually affects the big toe, but it can occur in any joint. Other commonly affected joints include the ankles, knees, elbows, wrists and fingers. The pain is likely to be most severe within the first four to 12 hours after it begins.

**Lingering discomfort.** After the most severe pain subsides, some joint discomfort may last from a few days to a few weeks. Later attacks are likely to last longer and affect more joints.

**Inflammation and redness.** The affected joint or joints become swollen, tender, warm and red.

**Limited range of motion.** As gout progresses, you may not be able to move your joints normally.



**The recommended supplement for Gout:** Elderberry & Vitamin C, Vitamin D3, & Platinum Turmeric

##### 1. Elderberry & Vitamin C

Elderberry and vitamin C are two natural remedies that have been widely studied and recognized for their potential benefits in managing gout, a type of arthritis characterized by severe pain, inflammation, and swelling in the joints. Elderberry, derived from the flowering plant *Sambucus nigra*, is rich in antioxidants and anti-inflammatory compounds that can help reduce the severity of gout symptoms. It has been traditionally used for centuries to treat various ailments, including joint pain and inflammation. Elderberry's anti-inflammatory properties can help alleviate the pain and swelling associated with gout, providing relief to individuals suffering from this condition. Additionally, elderberry's high antioxidant content can help neutralize free radicals in the body, which are known to contribute to inflammation and tissue damage. Vitamin C, on the other hand, is a powerful antioxidant that plays a crucial role in the body's immune system function. It has been found to have anti-inflammatory effects and can help reduce the levels of uric acid, a key factor in the development of gout. Uric acid is a waste product that forms when the body breaks down purines, which are found in certain foods. High levels of uric acid can lead to the formation of urate crystals, which accumulate in the joints and cause gout symptoms. By increasing the intake of vitamin C, individuals with gout can potentially lower their uric acid levels and minimize the risk of gout attacks. Moreover, vitamin C's antioxidant properties can further protect the joints from oxidative stress and inflammation. While elderberry and vitamin C are not a cure for gout, incorporating them into a comprehensive treatment plan that includes medication, dietary modifications, and lifestyle changes may help manage gout symptoms and improve overall joint health.

With these Elderberry and Vitamin C gummies, there is no need to worry about taking capsules or dealing with undesirable side effects such as digestive discomfort.

**Ingredients:** see Supplement Facts.

**Flavor:** Elderberry

**Manufacturer Country:** USA

**Product Amount:** 60 gummies

**Gross Weight:** 0.56lb (255g)

**Suggested Use:** Take two (2) gummies once a day as a dietary supplement.



**DRSOUS.CA Elderberry & Vitamin C Gummies**

Regular price: \$25.00 CAD  
Product Amount: 60 gummies  
Gross Weight: 0.56lb (255g)  
Packed with immune-boosting nutrients, including Vitamin C, Zinc, and Elderberry, this gummy is a popular way to receive antioxidants and boost overall health.

- Immune boosting
- Overall health
- Eases cold and flu symptoms
- Improves iron absorption

**Supplement Facts**

	Amount Per Serving	% Daily Value
	(Gummies)	(Based on 2 Gummies)
Total Gummies	60	100%
Vitamin C (Ascorbic Acid)	1000 mg	2000%
Zinc (Zinc Oxide)	15 mg	300%
Elderberry (Elderberry Extract)	100 mg	200%
Other Ingredients	4.0 mg	8%
Total Weight	255 g	100%
Net Weight	255 g	100%
Net Content	255 g	100%
Manufacture Date (Approx.)	10/19	

\*The Percent Daily Values are based on a diet of other people's secrets.  
©2019 DRSOUS.CA. All rights reserved. No part of this publication may be reproduced without written permission from DRSOUS.CA.  
Some ingredients derived from: Sugar, Natural Flavors, Pectin, Citric Acid, All Natural Elderberry, Alpha Hydroxy Acid, Vitamin C, Zinc Oxide, etc.

Paradise Wellness | A specific channel for Elderberry & Vitamin C on YouTube

Dr. Sous | www.drsous.ca

## 2. Vitamin D3

Vitamin D3 is a fat-soluble vitamin that supports the growth and development of bones and teeth. It also plays an essential role in the functioning of the muscles and boosting energy levels in the body.

The body naturally produces Vitamin D when exposed to sunlight, and you can also receive Vitamin D from some foods like oily fish. There is some evidence suggesting that vitamin D may have a potential impact on gout, a type of arthritis caused by the accumulation of urate crystals in the joints, leading to pain and inflammation.

**Inflammation regulation:** Vitamin D has been associated with the regulation of the body's inflammatory response. In gout, the inflammation is triggered by the immune system's response to urate crystals. Some studies suggest that adequate vitamin D levels may help modulate this immune response and reduce inflammation.

**Bone health:** Gout is often associated with joint damage and bone erosion. Vitamin D is essential for bone health, as it helps the body absorb calcium and maintain bone density. By promoting better bone health, vitamin D might potentially improve the overall condition of joints affected by gout.

**Uric acid metabolism:** There is limited evidence suggesting that vitamin D may influence uric acid levels in the blood. Some studies have found correlations between vitamin D deficiency and elevated uric acid levels.

**Ingredients:** see Supplement Facts.

**Manufacturer Country:** USA

**Product Amount:** 100 soft-gels

**Gross Weight:** 0.1lb (45g)

**Suggested Use:** As a dietary supplement, adults take one (1) softgel capsule daily or as directed by a health care professional. Store in a cool, dry place and away from direct light.



**DRSOUS.CA Vitamin D3 helps maintain bone density, strength and healthy cell growth**

Vitamin D3 is a fat-soluble vitamin that supports the growth and development of bones and teeth. It also plays an essential role in the functioning of the muscles and boosting energy levels in the body. The body naturally produces Vitamin D when exposed to sunlight, and you can also receive Vitamin D from some foods like oily fish. In the winter months, especially in colder regions, the body doesn't produce as much Vitamin D, which can lead to what's called 'seasonal depression.'

www.paradisewellness.ca | A specific channel for Supplements on YouTube

Dr. Sous | www.drsous.ca

### 3. Platinum Turmeric

Our Platinum Turmeric blend contains various forms of turmeric, glucosamine, Boswellia extract (frankincense), piperine, and several other highly beneficial natural extracts to keep you at your best. Gout is a type of inflammatory arthritis caused by the accumulation of uric acid crystals in the joints, leading to pain, swelling, and inflammation. Some studies have suggested that curcumin, found in turmeric, may have anti-inflammatory properties that could potentially benefit individuals with gout. The anti-inflammatory action of curcumin might help reduce the symptoms associated with gout and provide relief from pain and swelling.

**Ingredients:** see Supplement Facts.

**Manufacturer Country:** USA

**Product Amount:** 60 caps

**Gross Weight:** 0.25lb (113g)

**Suggested Use:** Take two (2) capsules once a day as a dietary supplement. For best results, take 20-30 min before a meal or as directed by your healthcare professional.



### 5) HEEL SPURS

A heel spur is a bony growth caused by a calcium deposit. These growths can occur in the back of or under your heel, or beneath the sole of your foot. Some people may not experience any symptoms, while others may have significant heel pain.

#### # Symptoms

- Symptoms of heel spurs can include:
- Sharp pain like a knife in the heel when standing up in the morning.
- A dull ache in the heel throughout the rest of the day.
- Inflammation and swelling at the front of the heel.
- Heat radiating from the affected area.
- Small, visible bone-like protrusion under the heel.

Factors that may increase the risk of heel spurs include:

- Overuse or repetitive stress on the feet, often seen in athletes or individuals with jobs that involve standing for long periods.
- Obesity or excess body weight, which puts extra strain on the feet.
- Poor footwear or inadequate support for the arches.
- Age, as heel spurs become more common as people get older.
- Certain foot conditions, such as flat feet or high arches, which can alter the distribution of weight on the foot.

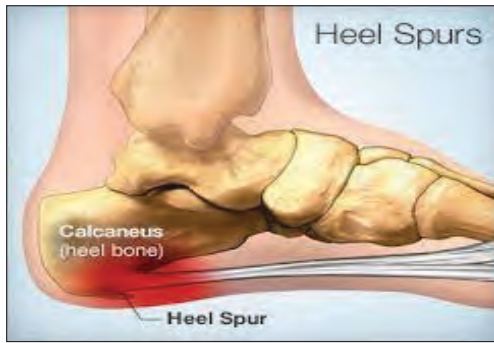

**The recommended supplement for Heel Spurs:** (Calcium, Vitamin D3, Platinum Turmeric, & Magnesium Glycinate)

### 1. Vitamin D3

Vitamin D3, also known as cholecalciferol, is a crucial vitamin that plays a significant role in maintaining bone health and calcium balance in the body. It is essential for the absorption of calcium and phosphorus from the intestines and their proper utilization in bone formation and mineralization. Vitamin D deficiency can lead to various bone-related issues, including weakened bones and increased risk of fractures. Heel spurs, also known as calcaneal spurs, are bony outgrowths that develop on the underside of the heel bone. They are often associated with plantar fasciitis, a condition where the plantar fascia (a thick band of tissue that runs along the bottom of the foot) becomes inflamed and causes heel pain. Heel spurs themselves might not cause pain, but the inflammation and irritation they cause to the surrounding tissues can lead to significant discomfort. There is some evidence suggesting that vitamin D deficiency may be linked to an increased risk of developing heel spurs indirectly. As vitamin D is essential for bone health, insufficient levels can lead to weakened bones, including the heel bone (calcaneus). This weakening could make the heel bone more susceptible to stress and strain, which may contribute to the development of heel spurs.

The body naturally produces Vitamin D when exposed to sunlight, and you can also receive Vitamin D from some foods like oily fish. In the winter months, especially in colder regions, the body doesn't produce as much Vitamin D, which can lead to what's called 'seasonal depression.'

**Ingredients:** see Supplement Facts.

**Manufacturer Country:** USA

**Product Amount:** 100 Soft-gels

**Gross Weight:** 0.1lb (45g)

**Suggested Use:** As a dietary supplement, adults take one (1) softgel capsule daily or as directed by a health care professional. Store in a cool, dry place and away from direct light.

**DRSOUS.CA Vitamin D3 helps maintain bone density, strength and healthy cell growth**

Vitamin D3 is a fat-soluble vitamin that supports the growth and development of bones and teeth. It also plays an essential role in the functioning of the muscles and boosting energy levels in the body. The body naturally produces Vitamin D when exposed to sunlight, and you can also receive Vitamin D from some foods like oily fish. In the winter months, especially in colder regions, the body doesn't produce as much Vitamin D, which can lead to what's called 'seasonal depression.'



154

www.puredrsous.com A specific channel for Supplements on YouTube

Dr. Soule | www.drsous.ca

## 2. Platinum Turmeric

Our Platinum Turmeric blend contains various forms of turmeric, glucosamine, Boswellia extract (frankincense), piperine, and several other highly beneficial natural extracts to keep you at your best.

Natural extracts have been used for centuries in Ayurvedic medicine to remedy illnesses. We harness and advance these natural extracts in modern times for optimal bioavailability and effectiveness.

**Ingredients:** see Supplement Facts.

**Manufacturer Country:** USA

**Product Amount:** 60 caps

**Gross Weight:** 0.25lb (113g)

**Suggested Use:** Take two (2) capsules once a day as a dietary supplement. For best results, take 20-30 min before a meal or as directed by your healthcare professional.

**DrSous.ca Platinum Turmeric 60 Capsule Bottle**  
Regular price: \$20.00 CAD  
Product Amount: 60 caps  
Gross Weight: 0.25lb (113g)  
Our Platinum Turmeric blend contains various forms of turmeric, glucosamine, Boswellia extract (frankincense), piperine, and several other highly beneficial natural extracts to keep you at your best.  
• Anti-inflammatory  
• Joint and bone health  
• Heart Protective  
• Anti-oxidant & Anti- Cancer

**Supplement Facts**  
Amount Per Serving %DV  
Curcumin (from Curcuma longa) 1000mg 200%  
Boswellia Extract (from Boswellia serrata) 1000mg 200%  
Glucosamine HCL (from Glucosamine) 500mg 100%  
Piperine (from Piper nigrum) 500mg 100%  
Other Ingredients: Cellulose, Magnesium Stearate, Croscarmellose, Polydextrose, Hydroxypropyl Methylcellulose, Polyethylene Glycol, and Titanium Dioxide.

Dr. Sous | www.drsous.ca

## 3. Magnesium Glycinate

Magnesium Glycinate is one of the most important nutrients needed throughout the body. It is most commonly used as a natural sleep vitamin that helps calm the brain, to help the body relax and fall and stay asleep. By doing this the body is able to be rejuvenated

**Magnesium Glycinate**  
Magnesium Glycinate is one of the most important nutrients needed throughout the body. It is most commonly used as a natural sleep vitamin that helps calm the brain, to help the body relax and fall and stay asleep. By doing this the body is able to be rejuvenated.

www.paradisewellness.ca | A specific channel for Supplements on YouTube

Dr. Sous | www.drsous.ca

## 6) SCIATICA, PIRIFORMIS SYNDROME

Sciatica refers to pain, weakness, numbness, or tingling from the lower back through the hips and buttocks and down to the leg. It is caused by injury to or pressure on the sciatic nerve. Sciatica most often occurs when a herniated disk or an overgrowth of bone puts pressure on part of the nerve. This causes inflammation, pain, and often some numbness in the affected side. What is piriformis syndrome? Piriformis syndrome occurs when your piriformis muscle compresses your sciatic nerve and results in inflammation. It can



## 2. B-12 Drops

B12 complex contains: Riboflavin-required for the proper development and function of the skin, lining of the digestive tract, Niacin-required for the proper function of fats and sugars in the body and to maintain healthy tissue, Vitamin B6-needed to maintain proper energy levels. B12 is a critical vitamin that is required for proper development of many body systems and tissues. Deficiency of B12 can lead to many problems such as memory loss and fatigue.



## 3. Magnesium Glycinate

Magnesium Glycinate is one of the most important nutrients needed throughout the body. It is most commonly used as a natural sleep vitamin that helps calm the brain, to help the body relax and fall and stay asleep. By doing this the body is able to be rejuvenated.



## 7) TENDONITIS (GOLFERS ELBOW, TENNIS ELBOW)

Tendinitis is inflammation of the thick fibrous cords that attach muscle to bone. These cords are called tendons. The condition causes pain and tenderness just outside a joint. Tendinitis can occur in any tendon. But it's most common around shoulders, elbows, wrists, knees and heels.

# **Symptoms:** The main symptoms of tendonitis are:

- Pain and tenderness in the affected tendon, which is often worse when you move it.
- Swelling.
- A grating sensation as the tendon moves.
- A lump on the tendon.
- Weakness in the affected area.
- Decreased range of motion.



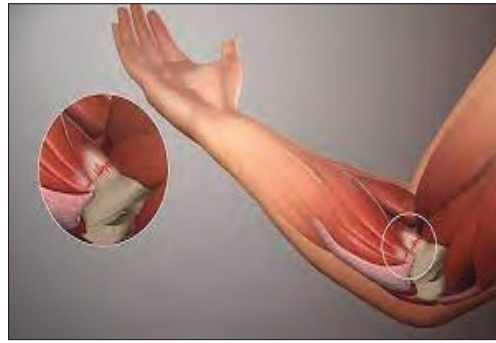

**The recommended supplement for Tendonitis:** (Vitamin C, Collagen, Platinum Turmeric)

### 1. Vitamin C

Ascorbic acid, another name for vitamin C, is a water-soluble vitamin that is vital for good health. Many physiological functions, such as collagen formation, wound healing, and immunological function, depend on it.

Tendonitis, also known as tendinitis, is the inflammation or irritation of a tendon, usually caused by overuse or repetitive movements. Vitamin C is an essential nutrient with various functions in the body, including collagen synthesis. Collagen is a key component of tendons, ligaments, and other connective tissues. Some people believe that taking vitamin C supplements may help with tendon healing and recovery due to its role in collagen formation.

Our Vitamin C Gummies are a healthy, on-the-go snack for the whole family. They provide you with the daily Vitamin C that your body needs to fight off free radicals, lower blood pressure, lower the risk of heart disease and boost the immune system against infection overall.

**Ingredients:** Vitamin C (as Ascorbic Acid), Glucose Syrup, Sugar, Glucose, Apple Juice (from concentrate), Pectin, Citric Acid, Sodium Citrate, Natural Strawberry flavor, Radish Red.

**Manufacturer Country:** USA

**Product Amount:** 60 gummies

**Gross Weight:** 0.37lb (170g)

**Suggested Use:** Take two (2) capsules once a day as a dietary supplement.



### 2. Collagen

Collagen is a protein found in the connective tissues of the body, including tendons, ligaments, cartilage, and skin. It plays a crucial role in providing strength, flexibility, and structural support to these tissues. As a result, collagen supplementation has been proposed as a potential treatment for conditions like tendonitis, which involves inflammation and irritation of the tendons.

Collagen Gummies are for those looking for healthy sweet snacks. These are the perfect replacement for traditional sugar gummies on the market since they provide your body with vital protein and collagen while also boosting your immune system with Vitamin C. Our collagen gummies are a powerful combination because Vitamin C aids collagen absorption into the bones. This greatly improves bone and joint strength and stability.

**Ingredients:** see Supplement Facts.

**Manufacturer Country:** USA

**Product Amount:** 60 gummies

**Gross Weight:** 0.56lb (255g)

**Suggested Use:** As a dietary supplement, take two (2) pieces once a day.

### 3. Platinum Turmeric:

Turmeric contains a compound called curcumin, which possesses anti-inflammatory and antioxidant properties. These properties make turmeric a potential natural remedy for tendonitis. Studies have suggested that curcumin may help reduce pain, swelling, and stiffness in individuals with tendonitis. Tendonitis is an inflammation of the tendons, which are the thick cords that attach muscles to bones. It commonly occurs due to overuse, injury, or repetitive movements. It is believed that curcumin inhibits certain inflammatory enzymes and mediators, thereby reducing the inflammatory response. However, it is important to note that the bioavailability of curcumin is relatively low, meaning that the body may not absorb it efficiently. To enhance absorption, it is often recommended to consume turmeric with black pepper, which contains a compound called piperine that can improve curcumin's bioavailability. Piperine, has been demonstrated to block a process in your body that removes compounds like curcuminoids, promoting improved absorption. Our platinum turmeric blend contains glucosamine, Boswellia extract (frankincense), piperine, and several other highly beneficial natural extracts to keep you at your best.

Natural extracts have been used for centuries in Ayurvedic medicine to remedy illnesses. We harness and advance these natural extracts in modern times for optimal bioavailability and effectiveness.

**Ingredients:** see Supplement Facts.

**Manufacturer Country:** USA

**Product Amount:** 60 caps

**Gross Weight:** 0.25lb (113g)

**Suggested Use:** Take two (2) capsules once a day as a dietary supplement. For best results, take 20-30 min before a meal or as directed by your healthcare professional.

## 8) ADHESIVE CAPSULITIS (FROZEN SHOULDER)

Frozen shoulder, also called adhesive capsulitis, causes pain and stiffness in the shoulder. Over time, the shoulder becomes very hard to move.



After a period of worsening symptoms, frozen shoulder tends to get better, although full recovery may take up to 3 years. Physical therapy, with a focus on shoulder flexibility, is the primary treatment recommendation for frozen shoulder.

Frozen shoulder most commonly affects people between the ages of 40 and 60, and occurs in women more often than men. In addition, people with diabetes are at an increased risk for developing frozen shoulder.

### # Symptoms

Frozen shoulder typically develops slowly in three stages.

**Freezing stage.** Any movement of the shoulder causes pain, and the shoulder's ability to move becomes limited. This stage lasts from 2 to 9 months.

**Frozen stage.** Pain might lessen during this stage. However, the shoulder becomes stiffer. Using it becomes more difficult. This stage lasts from 4 to 12 months.

**Thawing stage.** The shoulder's ability to move begins to improve. This stage lasts from 5 to 24 months.

For some people, the pain worsens at night, sometimes disrupting sleep.

**The recommended supplement for Adhesive Capsulitis (Frozen Shoulder) are:** Platinum Turmeric, Vitamin D3 and Collagen Peptides.

### 1. Platinum Turmeric

Our Platinum Turmeric blend contains various forms of turmeric, glucosamine, Boswellia extract (frankincense), chondroitin sulphate, piperine, and several other highly beneficial natural extracts to keep you at your best.

1. Turmeric: Turmeric contains an active compound called curcumin, which has anti-inflammatory properties. Some studies have suggested that curcumin may help reduce inflammation and pain associated with various conditions including frozen shoulder.
2. Boswellia: Boswellia, also known as Indian frankincense, is another herbal supplement with anti-inflammatory properties. Like turmeric, it may help reduce inflammation and pain.
3. Glucosamine: Glucosamine is a natural compound found in cartilage. It is commonly used as a supplement to support joint health.
4. Chondroitin sulfate: Chondroitin is another component of cartilage and is often combined with glucosamine in joint health supplements.
5. Bromelain: Bromelain is an enzyme derived from pineapple stems. It is known for its anti-inflammatory properties and is sometimes used as a natural remedy for reducing inflammation and swelling.

Natural extracts have been used for centuries in Ayurvedic medicine to remedy illnesses. We harness and advance these natural extracts in modern times for optimal bioavailability and effectiveness.

**Ingredients:** see Supplement Facts.

**Manufacturer Country:** USA

**Product Amount:** 60 caps

**Gross Weight:** 0.25lb (113g)

**Suggested Use:** Take two (2) capsules once a day as a dietary supplement. For best results, take 20-30 min before a meal or as directed by your healthcare professional.

**DrSous.ca Platinum Turmeric 60 Capsule Bottle**  
Regular price: \$20.00 CAD  
Product Amount: 60 caps  
Gross Weight: 0.25lb (113g)

Our Platinum Turmeric blend contains various forms of turmeric, glucosamine, Boswellia extract (frankincense), piperine, and several other highly beneficial natural extracts to keep you at your best.

- Anti-inflammatory
- Joint and bone health
- Heart Protective
- Anti-oxidant & Anti- Cancer

**Supplement Facts**

	Amount Per Serving	% DV
<b>Serving Size: 2 Capsules</b>		
<b>Total Turmeric</b>	600mg	120%
<b>Curcumin</b>	150mg	30%
<b>Curcuminol</b>	150mg	30%
<b>Curcuminoids</b>	150mg	30%
<b>Glucosamine</b>	500mg	100%
<b>Boswellia Extract</b>	100mg	100%
<b>Black Pepper</b>	50mg	100%
<b>Other Ingredients:</b> Cellulose (Vegetarian Capsules), Croscellulose, Magnesium Stearate, Silicon Dioxide, and Natural Flavors.		

142

Dr. Sous | www.drsous.ca

## 2. Vitamin D3

Vitamin D3 is a fat-soluble vitamin that supports the growth and development of bones and teeth. It also plays an essential role in the functioning of the muscles and boosting energy levels in the body.

Frozen shoulder, also known as adhesive capsulitis, is a condition characterized by pain and stiffness in the shoulder joint. It can severely limit the range of motion and cause considerable discomfort. Vitamin D is crucial for overall health and plays a role in bone health and calcium absorption. There is some evidence suggesting that vitamin D deficiency might be associated with musculoskeletal issues, including joint pain and inflammation.

The body naturally produces Vitamin D when exposed to sunlight, and you can also receive Vitamin D from some foods like oily fish. In the winter months, especially in colder regions, the body doesn't produce as much Vitamin D, which can lead to what's called 'seasonal depression.'

**Ingredients:** see Supplement Facts.

**Manufacturer Country:** USA

**Product Amount:** 100 soft-gels

**Gross Weight:** 0.1lb (45g)

**Suggested Use:** As a dietary supplement, adults take one (1) soft-gel capsule daily or as directed by a health care professional. Store in a cool, dry place and away from direct light.

**DRSOUS.CA Vitamin D3 helps maintain bone density, strength and healthy cell growth**

Vitamin D3 is a fat-soluble vitamin that supports the growth and development of bones and teeth. It also plays an essential role in the functioning of the muscles and boosting energy levels in the body. The body naturally produces Vitamin D when exposed to sunlight, and you can also receive Vitamin D from some foods like oily fish. In the winter months, especially in colder regions, the body doesn't produce as much Vitamin D, which can lead to what's called 'seasonal depression.'

**VITAMIN D3**

154

Dr. Sous | www.drsous.ca





## 2. Vitamin D3

Vitamin D3 is a fat-soluble vitamin that supports the growth and development of bones and teeth. It also plays an essential role in the functioning of the muscles and boosting energy levels in the body. Vitamin D3 is an essential nutrient that plays a crucial role in maintaining bone health and supporting the immune system. Some research suggests that vitamin D deficiency may be linked to various musculoskeletal conditions, including back pain.

Here's what you need to know about vitamin D3 and its potential role in back pain:

**Bone health:** Vitamin D is essential for the absorption of calcium, which is necessary for maintaining strong bones. Insufficient vitamin D levels can lead to weakened bones and an increased risk of fractures, which can contribute to back pain.

**Inflammation:** Vitamin D also plays a role in modulating the immune system and reducing inflammation. Chronic inflammation may be associated with certain types of back pain, and optimizing vitamin D levels may help in managing inflammation.

**Muscle function:** Some studies have suggested that vitamin D might have an impact on muscle function and strength. Weak back muscles can contribute to back pain, and maintaining adequate vitamin D levels might potentially support muscle health.

The body naturally produces Vitamin D when exposed to sunlight, and you can also receive Vitamin D from some foods like oily fish. In the winter months, especially in colder regions, the body doesn't produce as much Vitamin D, which can also lead to 'seasonal depression.'

**Ingredients:** See Supplement Facts.

**Manufacturer Country:** USA

**Product Amount:** 100 Soft-gels

**Gross Weight:** 0.1lb (45g)

**Suggested Use:** As a dietary supplement, adults take one (1) soft-gel capsule daily or as directed by a health care professional. Store in a cool, dry place and away from direct light.



## 3. Magnesium Glycinate

Magnesium Glycinate is one of the most important nutrients needed throughout the body. Magnesium glycinate is a supplement that combines the essential mineral magnesium with the amino acid glycine. Magnesium is involved in numerous bodily processes and is known to play a role in muscle function, nerve transmission, and bone health. While magnesium deficiency can contribute to muscle cramps and spasms, there isn't substantial evidence to suggest that magnesium glycinate alone is a definitive treatment for back pain. However, some studies have shown that magnesium supplementation can be helpful for certain types of back pain, especially if the pain is related to muscle tension or spasms. Magnesium's muscle-relaxant properties may help alleviate muscle tightness and discomfort.

Additionally, magnesium can contribute to overall bone health, which might indirectly benefit those experiencing back pain due to osteoporosis or other bone-related issues.



### 10) ROTATOR CUFF INJURIES

The rotator cuff is a group of muscles and tendons that surround the shoulder joint, keeping the head of the upper arm bone firmly within the shallow socket of the shoulder. A rotator cuff injury can cause a dull ache in the shoulder that worsens at night. Rotator cuff injuries are common and increase with age.

#### # Symptoms

The most common symptoms of a rotator cuff tear include: Pain at rest and at night, particularly if lying on the affected shoulder. Pain when lifting and lowering your arm or with specific movements. Weakness when lifting or rotating your arm.

The pain associated with a rotator cuff injury may:

- Be described as a dull ache deep in the shoulder
- Disturb sleep
- Make it difficult to comb your hair or reach behind your back
- Be accompanied by arm weakness
- Some rotator cuff injuries don't cause pain.

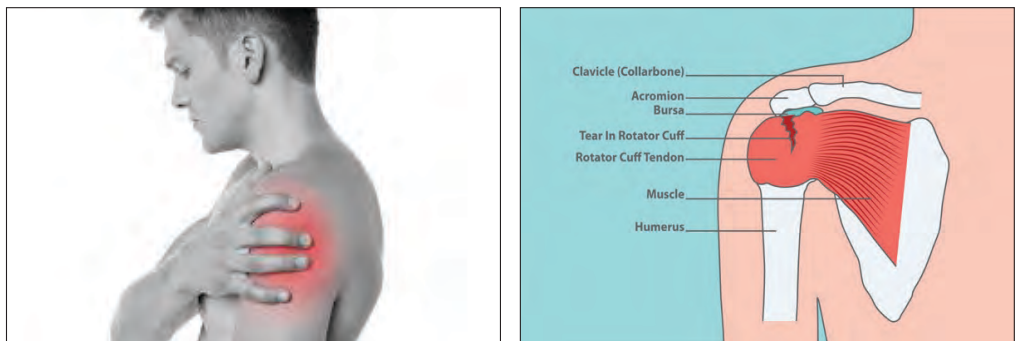

A rotator cuff injury typically involves inflammation of the tendons and muscles around the shoulder joint, leading to pain and limited range of motion. Treatment for rotator cuff injuries usually involves rest, physical therapy, and, in severe cases, surgery.

**The recommended supplements for Rotator Cuff Injuries:** Platinum Turmeric, Collagen Peptides, Magnesium Glycinate)





Collagen is loaded with the amino acids glycine, proline, hydroxyproline, and alanine which help to promote collagen synthesis in the body. However, as the body ages, it produces less collagen, making collagen supplementation crucial for increased longevity. Our Grass-Fed Collagen Peptide Powder contains collagen types 1 and 3, which are necessary for healthy skin, muscles, and bones. Mix with your favorite beverage, hot or cold, for an added collagen boost.

**Ingredients:** see Supplement Facts.

**Flavor:** Chocolate

**Manufacturer Country:** USA

**DRSOUS.CA Grass-Fed Collagen Peptides Powder (Chocolate flavor)**  
 Regular price: \$55.95 CAD  
 Product Amount: 376g (0.83lb)  
 Gross Weight: 0.98lb (444g)  
 Grass-Fed Collagen Peptide Powder is a delicious way for people to maintain joint health and skin elasticity as they age.

- Promotes healthy bones and joints
- Improved skin elasticity
- Strengthens connective tissue in the body
- Improves gut health

**Supplement Facts**  
 Serving Size: 2 Scoops (27g)  
 Servings Per Container: 14

	Amount Per Serving	% Daily Value*
Calories	0	
Total Carbohydrates	2g	100%
Dietary Fiber	2g	100%
Protein	18g	
Collagen	26mg	26%
Sodium	100mg	20%
Hydrolyzed Collagen	29g	

\*Percent Daily Values are based on a diet of 2,000 calories per day.  
 \*\*Daily Values not established.  
 †Other Ingredients: Natural flavors, organic powder, natural flavors, with an organic, certified pure, source certified powder from AU 9504.

120

Paradise Wellness | A specific channel for Grass-Fed Collagen Peptides on YouTube

Dr. Sous | www.drsous.ca

### 3. Magnesium Glycinate

Magnesium Glycinate is one of the most important nutrients needed throughout the body. Magnesium Glycinate, a form of magnesium that has amino acid glycine, is believed to have several beneficial properties that can aid in the healing process of rotator cuff injuries. Firstly, magnesium is involved in over 300 biochemical reactions in the body, including muscle relaxation and contraction. It plays a crucial role in the production of adenosine triphosphate (ATP), which is the energy currency of our cells. By supplementing with magnesium glycinate, individuals with rotator cuff injuries may experience improved muscle function and reduced muscle spasms, leading to a decrease in pain and discomfort. Additionally, magnesium has been shown to have anti-inflammatory properties. Inflammation is a natural response to tissue damage, but when it becomes chronic, it can hinder the healing process. Magnesium helps regulate inflammatory pathways in the body, potentially reducing the duration and severity of inflammation associated with rotator cuff injuries. By reducing inflammation, magnesium glycinate may promote a faster and more efficient healing process. Furthermore, magnesium is known to support bone health and density. By ensuring an adequate intake of magnesium, individuals with rotator cuff injuries may promote the strength and integrity of their bones, reducing the risk of further damage or complications.

**Magnesium Glycinate**

Magnesium Glycinate is one of the most important nutrients needed throughout the body. It is most commonly used as a natural sleep vitamin that helps calm the brain, to help the body relax and fall and stay asleep. By doing this, the body is able to be rejuvenated.

160

www.paradisewellness.ca | A specific channel for Supplements on YouTube

Dr. Sous | www.drsous.ca

## 11) PLANTER FASCIITIS

Plantar fasciitis is the inflammation of the plantar fascia, tissue in the foot used during walking and foot movement. Plantar fasciitis can be caused by a number of factors, including type of shoes, foot structure, overuse and types of walking surfaces. The main symptom of plantar fasciitis is heel pain.

- Plantar fasciitis is the inflammation of the plantar fascia, tissue in the foot used during walking and foot movement.
- Plantar fasciitis can be caused by a number of factors, including type of shoes, foot structure, overuse and types of walking surfaces.
- The main symptom of plantar fasciitis is heel pain.

Treatment for plantar fasciitis usually does not require surgery.

### # Symptoms

The pain of plantar fasciitis usually increases gradually and is typically felt near the heel. Sometimes the pain can be sudden, occurring after missing a step or jumping from a height. The pain tends to be the worst when you get up in the morning or after other periods of inactivity. That's why it is known as first-step pain. The degree of discomfort can sometimes lessen with activity during the day or after warming up but it can become worse after prolonged or vigorous activity. The pain may also appear more intense in bare feet or in shoes with minimal support.

Plantar fasciitis can be distinguished from heel spurs and other conditions based on medical history and examination by a physician. Heel spurs are often wrongly thought to be the sole cause of heel pain. Although they are common, they are nothing more than the bone's response to traction or pulling forces from the plantar fascia and other foot muscles. Heel spurs often don't cause any pain. A truly enlarged and problematic spur requiring surgery is rare.

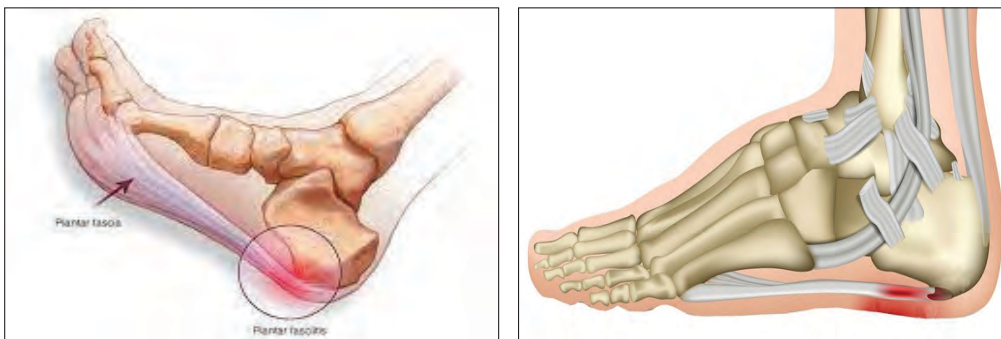

**The recommended supplements for Planter Fasciitis:** Vitamin C, Vitamin D3, Platinum Turmeric.

### 1. Vitamin C

Our Vitamin C Gummies are a healthy, on-the-go snack for the whole family. They provide you with the daily Vitamin C that your body needs to fight off free radicals, lower blood pressure, lower the risk of heart disease and boost the immune system against infection overall.

Plantar fasciitis is a common foot condition that causes pain and discomfort in the heel and bottom of the foot. It occurs when the plantar fascia, a thick band of tissue that runs along the bottom of the foot, becomes inflamed or irritated. Many treatment options exist for plantar fasciitis, including physical therapy, orthotics, and pain medications. However, recent research has suggested that vitamin C may also play a role in managing this condition. Vitamin C is a powerful antioxidant that is known to have anti-inflammatory properties. It is essential for the synthesis of collagen, a protein that helps maintain the health and integrity of connective tissues, including the plantar fascia. Studies have shown that individuals with plantar fasciitis often have lower levels of vitamin C in their blood compared to those without the condition. Furthermore, supplementation with vitamin C has been found to reduce pain and improve function in individuals with plantar fasciitis. The exact mechanism by which vitamin C helps alleviate the symptoms of plantar fasciitis is not yet fully understood. However, it is believed that its anti-inflammatory properties may help reduce inflammation in the plantar fascia, leading to pain relief and improved mobility.

**Ingredients:** Vitamin C (as Ascorbic Acid), Glucose Syrup, Sugar, Glucose, Apple Juice (from concentrate), Pectin, Citric Acid, Sodium Citrate, Natural Strawberry flavor, Radish Red.

**Manufacturer Country:** USA

**Product Amount:** 60 gummies

**Gross Weight:** 0.37lb (170g)

**Suggested Use:** Take two (2) capsules once a day as a dietary supplement.

**Caution:** Do not exceed recommended dose. Pregnant or nursing mothers, children under the age of 18, and individuals with a known medical condition should consult a physician before using this or any dietary supplement.

**DrSous.Ca Vitamin C Gummies**  
Regular price: \$12.85 CAD  
Product Amount: 60 gummies  
Gross Weight: 0.37lb (170g)  
Vitamin C Gummies are an effective way to get the necessary daily Vitamin C for your body. They provide you with the daily Vitamin C that your body needs to fight off free radicals, lower blood pressure, lower the risk of heart disease and boost the immune system against infection overall.

Amount Per Serving	%DV*
Calories	12
Calories from Fat	0
Total Carbohydrates	3g 1%
Sugar	2g 4%
Vitamin C (as Ascorbic Acid)	60mg 67%

\*The % Daily Value (%DV) tells you how much a nutrient in a serving of food contributes to a daily diet. 2,000 calories a day is used for general nutrition advice.

A specific channel for Vitamin C on YouTube

153

## 2. Vitamin D3

Vitamin D3 is a fat-soluble vitamin that supports the growth and development of bones and teeth. It also plays an essential role in the functioning of the muscles and boosting energy levels in the body.

Vitamin D3, also known as the “sunshine vitamin,” plays a crucial role in maintaining bone health and regulating calcium levels in the body. Recent research suggests that adequate levels of vitamin D3 may help alleviate the symptoms of plantar fasciitis. Vitamin D3 supplementation has been shown to have anti-inflammatory properties, which can help reduce the inflammation and pain associated with plantar fasciitis. Additionally, vitamin D3 is involved in muscle function and repair, which may aid in the healing process of the damaged plantar fascia. It is important to note that while vitamin D3 supplementation may be beneficial, it should be used in conjunction with other treatment modalities, such as stretching exercises, physical therapy, and orthotic devices.

**Ingredients:** see Supplement Facts.

**Manufacturer Country:** USA

**Product Amount:** 100 soft-gels

**Gross Weight:** 0.1lb (45g)

**Suggested Use:** As a dietary supplement, adults take one (1) softgel capsule daily or as directed by a health care professional. Store in a cool, dry place and away from direct light.

**DRSOUS.CA Vitamin D3 helps maintain bone density, strength and healthy cell growth**

Vitamin D3 is a fat-soluble vitamin that supports the growth and development of bones and teeth. It also plays an essential role in the functioning of the muscles and boosting energy levels in the body. The body naturally produces Vitamin D when exposed to sunlight, and you can also receive Vitamin D from some foods like oily fish. In the winter months, especially in colder regions, the body doesn't produce as much vitamin D, which can lead to what's called 'seasonal depression.'

A specific channel for Supplements on YouTube

154

### 3. Platinum Turmeric

Our Platinum Turmeric blend contains various forms of turmeric, glucosamine, Boswellia extract (frankincense), piperine, and several other highly beneficial natural extracts to keep you at your best.

Platinum Turmeric is a specially formulated supplement that combines the power of turmeric, a natural anti-inflammatory agent, with other potent ingredients to target the root causes of Plantar Fasciitis. Turmeric has been used for centuries in traditional medicine for its healing properties, and its active compound, curcumin, has been extensively studied for its anti-inflammatory and pain-relieving effects. By incorporating turmeric into Platinum Turmeric, individuals with Plantar Fasciitis can experience reduced inflammation, alleviated pain, and improved mobility. Unlike traditional pain medications that often come with unwanted side effects, Platinum Turmeric offers a natural alternative that supports the body's healing process without causing additional harm.

Natural extracts have been used for centuries in Ayurvedic medicine to remedy illnesses. We harness and advance these natural extracts in modern times for optimal bioavailability and effectiveness.

**Ingredients:** see Supplement Facts.

**Manufacturer Country:** USA

**Product Amount:** 60 caps

**Gross Weight:** 0.25lb (113g)

**Suggested Use:** Take two (2) capsules once a day as a dietary supplement. For best results, take 20-30 min before a meal or as directed by your healthcare professional.

**DrSous.ca Platinum Turmeric 60 Capsule Bottle**  
Regular price: \$20.00 CAD  
Product Amount: 60 caps  
Gross Weight: 0.25lb (113g)  
Our Platinum Turmeric blend contains various forms of turmeric, glucosamine, Boswellia extract (frankincense), piperine, and several other highly beneficial natural extracts to keep you at your best.

- Anti-inflammatory
- Joint and bone health
- Heart Protective
- Anti-oxidant & Anti- Cancer

**Supplement Facts**  
Serving Size: 2 Capsules  
Servings Per Container: 30

Amount Per Serving	% Daily Value
Glucosamine HCL (Type II)	100%
Curcumin (Type I)	100%
Black Pepper (Type I)	100%
Boswellia Extract (Type I)	100%
MSM (Type I)	100%
Chondroitin Sulfate	100%
Devil's Claw (Type I)	100%
MSM (Type II)	100%
MSM (Type III)	100%
MSM (Type IV)	100%
MSM (Type V)	100%
MSM (Type VI)	100%
MSM (Type VII)	100%
MSM (Type VIII)	100%
MSM (Type IX)	100%
MSM (Type X)	100%
MSM (Type XI)	100%
MSM (Type XII)	100%
MSM (Type XIII)	100%
MSM (Type XIV)	100%
MSM (Type XV)	100%
MSM (Type XVI)	100%
MSM (Type XVII)	100%
MSM (Type XVIII)	100%
MSM (Type XIX)	100%
MSM (Type XX)	100%

Other Ingredients: Cellulose, Vegetable Capsules, Rice Flour.  
CONTAINS: Shellfish (Crustaceans, Lobster and Crustaceans).

Paradise Wellness  
A specific channel for Platinum Turmeric on YouTube

Dr. Sous | www.drsous.ca

## CHAPTER II. HEAD & SPINAL CORD

Together, the brain and spinal cord form the central nervous system. This complex system is part of everything we do. It controls the things we choose to do like walk and talk and the things our body does automatically like breathe and digest food. The brain is a complex organ made up of specialized nerve and supportive tissues. It's surrounded by many bones that together form the skull. The part of the skull where the brain sits is called the cranium. The base, or lower part, of the brain is connected to the spinal cord. Together, the brain and spinal cord are known as the central nervous system (CNS). Many nerves send electrical signals to and from the brain and spinal cord. The brain is the body's control centre. It constantly receives and interprets nerve signals from the body and sends new signals based on this information. Different parts of the brain control movement, speech, emotions, consciousness and internal body functions, such as heart rate, breathing and body temperature. The brain has 3 main parts: cerebrum, cerebellum & brain stem

### 1) SLEEPING ISSUES

Sleep is an essential part of life. Multiple studies have shown that a good night's rest is crucial for optimal body and mind functionality. In today's fast-paced world, it can be difficult for some to fall asleep and, more importantly, into REM sleep.

Rapid eye movement (REM) sleep is essential for learning and memory. During this deep sleep, your brain interprets and analyzes your experiences of the day and stores them in your long-term memory.

There are several different types of sleep-wake disorders, of which insomnia is the most common. Other sleep-wake disorders include obstructive sleep apnea, parasomnias, narcolepsy, and restless leg syndrome. Sleep difficulties are linked to both physical and emotional problems.

#### What are the 5 major sleep disorders?

##### 5 Major Sleep Disorders

- Restless Legs Syndrome (RLS) RLS is a condition that causes your legs to move or shake because of an unpleasant sensation.
- Insomnia.
- REM Sleep Behavior Disorder (RBD)
- Sleep Apnea.
- Narcolepsy.



**The recommended supplements for sleep problems are:** Sleep Well Gummies, Nootropic Brain & Focus, & 5-HTP.

**1. Sleep Well Gummies:** Our sleep well gummies are a good mix of melatonin and passiflora incarnate which helps induce sleep. Your brain releases the hormone melatonin in reaction to darkness. It aids in sleep as well as the timing of your circadian rhythms (24-hour internal clock). Light exposure at night can prevent the generation of melatonin. Melatonin is produced and released by the brain according to the time of day, rising in the dark and falling in the light. As age, melatonin production decreases. Melatonin levels can be low in those who struggle to fall asleep. Hence, melatonin addition to supplements may aid in improving sleep. Melatonin and passiflora have been demonstrated to help people with insomnia fall asleep and unwind. It increases the amount of gamma-aminobutyric acid (GABA) in your brain, according to preliminary studies. The reduced brain activity caused by this substance may aid in relaxation and

improved sleep. Strong antioxidants as quercetin, apigenin, and vitexin are included in antioxidant Passiflora preparations. It also improves mental acuity and memory. The process of learning and long-term memory is deep REM sleep. Without sleep, the body would be susceptible to a wide range of illnesses since sleep controls the body's automatic functioning. Effective for treating blind people's circadian rhythm sleep disturbances. Both adults and children who have these diseases may benefit from melatonin. Difficulty falling asleep at a regular bedtime (delayed sleep phase syndrome). Melatonin taken orally appears to reduce the amount of time needed for young adults and children with this condition to fall asleep.

**Ingredients:** see Supplement Facts.

**Manufacturer Country:** USA

**Product Amount:** 60 gummies

**Gross Weight:** 0.56lb (255g)



## 2. Nootropic Brain & Focus

Nootropic Brain & Focus Formula combines a number of powerful amino acids such as Dimethylaminoethanol (DMAE Bitartrate), L-Glutamine, L-Tyrosine, and GABA, which enhance neuroactivity with plant extracts such as Bacopa that alter neurochemistry to improve focus, learning, and intelligence. With the increasing demands and stress of modern life, many individuals struggle with maintaining focus, concentration, and a good night's sleep. This formula combines the power of nootropic ingredients with sleep-enhancing compounds to provide a comprehensive solution for those seeking mental clarity and restful sleep. The nootropic ingredients in this formula are specifically chosen for their ability to support brain health, memory, and overall cognitive performance. These ingredients include natural substances like Bacopa Monnieri, which has been traditionally used in Ayurvedic medicine to improve memory and reduce anxiety, and Ginkgo Biloba, which may enhance cognitive function and blood flow to the brain. Additionally, the formula incorporates sleep-promoting compounds such as L-theanine, an amino acid known for its relaxation properties, and melatonin, a hormone that regulates the sleep-wake cycle. By combining these ingredients, the Nootropic Brain & Focus Formula for sleep offers a unique approach to supporting both mental acuity and restorative sleep. With regular use, individuals may experience improved focus, enhanced memory, reduced anxiety, and a more restful and rejuvenating sleep.

**Ingredients:** see Supplement Facts.

**Manufacturer Country:** USA

**Product Amount:** 60 caps

**Gross Weight:** 0.25lb (133g)

**Suggested Use:** As a dietary supplement, take two (2) veggie capsules once a day. For best results, take 20-30 min before a meal with an 8oz. glass of water or as directed by your healthcare professional

**Caution:** Do not exceed recommended dose. Pregnant or nursing mothers, children under the age of 18, and individuals with a known

medical condition should consult a physician before using this or any dietary supplement.

**Iron Warning:** Accidental overdose of iron-containing products is a leading cause of fatal poisoning in children under 6. Call a doctor or poison control center immediately in case of accidental overdose.



### 3. 5-HTP

5-Hydroxytryptophan, commonly known as 5-HTP, is a naturally occurring amino acid and a precursor to serotonin, a neurotransmitter that plays a crucial role in regulating sleep and mood. When it comes to improving sleep, 5-HTP has gained attention as a potential supplement. By increasing serotonin levels in the brain, 5-HTP can help promote relaxation, reduce anxiety, and induce a sense of calmness, which ultimately contributes to a better night's sleep. Additionally, 5-HTP has been found to aid in the production of melatonin, a hormone that regulates sleep-wake cycles. By supporting the melatonin synthesis process, 5-HTP may help individuals fall asleep faster and experience more restful sleep throughout the night. This supplement has also been studied for its potential benefits in managing sleep disorders such as insomnia and sleep apnea.

Because serotonin regulates mood and behavior, 5-HTP may improve:

- Sleep
- Mood
- Anxiety
- Hunger
- Pain sensitivity

Since 5-HTP is naturally present in the body, supplementing with it is a clean, holistic way to increase serotonin levels.

**Ingredients:** see Supplement Facts.

**Manufacturer Country:** USA

**Product Amount:** 60 caps

**Gross Weight:** 0.25lb (113g)

**Suggested Use:** Take two (2) capsules once a day as a dietary supplement. For best results, take 20-30 min before a meal with an 8oz glass of water or as directed by your healthcare professional.





## 2) BRAIN FOG

Brain fog is characterized by confusion, forgetfulness, and a lack of focus and mental clarity. This can be caused by overworking, lack of sleep, stress, and spending too much time on the computer.

What are 6 possible causes of brain fog?

An inflammatory response. While we mostly relate inflammation to joints, did you know your brain can become inflamed too?

- Asthma and allergies.
- Anxiety, depression and stress.
- Cancer treatments.
- Hormonal changes.
- Sleep.



### # Symptoms

Your brain fog might look different from someone else's. You might be tired and prone to confusion, while they might feel forgetful and unable to focus. Both can be considered cases of "brain fog," even if they're experienced differently.

1. Clouding of consciousness
2. Fatigue
3. Confusion
4. Lack of focus
5. Difficulty Concentrating
6. Forgetfulness



**The recommended supplement for brain fog are:** Nootropic Brain & Focus, Ginkgo Biloba + Ginseng, Magnesium Glycinate, & Neuro Plus.

### 1. Nootropic Brain & Focus

Nootropic Brain & Focus supplements have gained significant attention in recent years as people look for ways to combat brain fog and enhance their cognitive abilities. Brain fog, often characterized by a lack of mental clarity, poor concentration, and difficulty in processing information, can be caused by various factors such as stress, lack of sleep, or an unhealthy lifestyle. Nootropics, also known as

smart drugs or cognitive enhancers, are substances that aim to improve brain function, including memory, focus, creativity, and overall mental performance. These supplements typically contain a blend of natural ingredients, vitamins, and minerals that work synergistically to support brain health and optimize cognitive function. Some common ingredients found in nootropic formulas include bacopa monnieri, ginkgo biloba, phosphatidylserine, and L-theanine, among others. These ingredients have been studied for their potential to enhance memory, increase attention span, and improve overall cognitive performance. Nootropics work by increasing blood flow to the brain, promoting the production of neurotransmitters, and protecting brain cells from oxidative stress. By doing so, they may help reduce brain fog and enhance focus and mental clarity.

**Ingredients:** see Supplement Facts.

**Manufacturer Country:** USA

**Product Amount:** 60 caps

**Gross Weight:** 0.25lb (133g)

**Suggested Use:** As a dietary supplement, take two (2) veggie capsules once a day. For best results, take 20-30 min before a meal with an 8oz. glass of water or as directed by your healthcare professional



## 2. Ginkgo Biloba + Ginseng

The plant ginkgo biloba is utilized in traditional Chinese medicine because it has powerful antioxidant qualities. One of the oldest and most popular brain supplements for greater mental performance is ginkgo biloba. Mix it with ginseng for benefits to the immune system, blood flow, oxygen, and nutritional absorption in the brain.

- Age-defying and holistic health
- Enhanced cognition and memory
- Powerful antioxidant

Ginkgo Biloba and Ginseng have long been used as herbal remedies to combat brain fog and enhance cognitive function. Brain fog, characterized by difficulty concentrating, memory lapses, and mental fatigue, can be a result of various factors such as stress, lack of sleep, or an overwhelming workload. Ginkgo Biloba, derived from the leaves of the Ginkgo tree, is known for its neuroprotective properties. It contains powerful antioxidants that help improve blood circulation to the brain, ensuring optimal oxygen and nutrient delivery to brain cells. This increased blood flow can enhance cognitive performance, sharpen memory, and alleviate brain fog. Ginseng, on the other hand, is a renowned adaptogenic herb that has been used for centuries in traditional medicine. It is believed to improve mental clarity, focus, and overall brain function. Ginseng acts as a stimulant, helping to combat fatigue and boost energy levels, which can be particularly beneficial for those experiencing brain fog. Additionally, both Ginkgo Biloba and Ginseng possess anti-inflammatory properties that can help reduce inflammation in the brain, which has been linked to cognitive decline and brain fog.

**Ingredients:** See Supplement Facts.

**Manufacturer Country:** USA

**Product Amount:** 60 caps

**Gross Weight:** 0.25lb (133g)

**Suggested Use:** As a dietary supplement, take two (2) capsules before bedtime or as directed by your healthcare professional.

**DrSous.Ca Ginkgo Biloba + Ginseng**  
Regular price: \$29.00 CAD  
Product Amount: 60 caps  
Gross Weight: 0.25lb (133g)  
Ginkgo Biloba is a herb used in ancient Chinese medicine for its effective antioxidant properties. Ginkgo Biloba is one of the oldest and most-commonly-used brain supplement for better mental function. Combine it with Ginseng for benefits to blood flow, oxygen, nutrient absorption in the brain & to strengthen the immune system.

- Anti-aging
- Helps to combat cold and flu symptoms.
- Improved memory and cognition
- Strong antioxidant

	Amount Per Serving	% DV
Red Panax Ginseng Extract (Standardized to 76% ginsenosides)	300mg	**
Ginkgo Biloba Leaf Powder	400mg	**
Ginkgo Biloba Leaf 24% Flavonols	120mg	**

\*\* Daily Value (DV) not established.

Other Ingredients: Vegetable Cellulose, Vegetable Stearate, Silicon Dioxide.

Paradise Wellness | Dr. Sous | www.drsous.ca

### 3. Magnesium Glycinate

Magnesium Glycinate, a form of magnesium that is easily absorbed by the body, is believed to have beneficial effects on cognitive function and mental clarity. Magnesium is an essential mineral involved in numerous biochemical processes in the body, including neurotransmitter synthesis, nerve transmission, and energy production. It plays a crucial role in maintaining brain health and function. Research suggests that magnesium deficiency may contribute to cognitive impairments and the development of brain fog. By supplementing with Magnesium Glycinate, individuals may be able to increase their magnesium levels and potentially alleviate the symptoms of brain fog. Magnesium Glycinate has been reported to have calming effects on the nervous system, promoting relaxation and reducing anxiety, which can further enhance mental clarity. Additionally, it may support healthy sleep patterns, as magnesium is known to play a role in regulating sleep-wake cycles.

**Magnesium Glycinate**

Magnesium Glycinate is one of the most important nutrients needed throughout the body. It is most commonly used as a natural sleep vitamin that helps calm the brain, to help the body relax and fall and stay asleep. By doing this the body is able to be rejuvenated.

www.paradisewellness.ca | A specific channel for Supplements on YouTube

Dr. Sous | www.drsous.ca

### 3) IMPROVE MEMORY & FOCUS

Memory loss: Tips to improve your memory

- Be physically active every day. Physical activity raises blood flow to the whole body, including the brain.
- Stay mentally active.
- Spend time with others.
- Stay organized.

- Eat a healthy diet.
- Manage chronic health problems.
- Spend less time on the computer and mobile phone remind yourself to take a break.
- Positive thinking, reduce stress.
- Get enough sleep – 7-8 hours a day, go to bed at 10pm or no later than midnight.
- Regular exercise.
- Avoid alcohol, smoking, and drinking coffee in the afternoon



**The recommended supplements to Improve Memory & Focus:** Moringa Pure, Neuro Plus, & Nootropic Brain & Focus.

### 1. Moringa Pure

Moringa Oleifera is a tree that originates from Northern India and has been praised for its health benefits for centuries. It's most famous for its impressive nutritional content with high levels of antioxidants and bioactive plant compounds.

Almost all parts of the tree are used in traditional medicine, where people can expect to get a high dose of protein, Vitamin C, Vitamin B6, Riboflavin, and iron.

Moringa Pure is a natural supplement that has gained significant attention in recent years due to its potential to improve memory and focus. Derived from the leaves of the Moringa oleifera tree, this nutrient-rich plant has been used for centuries in traditional medicine for its numerous health benefits. Moringa Pure is packed with essential vitamins, minerals, and antioxidants that play a crucial role in brain health. It contains high levels of vitamin C, vitamin E, and beta-carotene, which are known for their ability to protect brain cells from oxidative stress and damage. Additionally, Moringa Pure is a rich source of B vitamins, including thiamine, riboflavin, and niacin, which are essential for proper brain function and the production of neurotransmitters. These neurotransmitters, such as dopamine and serotonin, are vital for regulating mood, memory, and cognitive function. By providing the brain with the necessary nutrients, Moringa Pure helps support the overall health of brain cells, promoting improved memory and focus. Moreover, Moringa Pure has been found to contain natural compounds called flavonoids and polyphenols, which have been shown to enhance cognitive function and prevent age-related cognitive decline. These compounds have neuroprotective properties and can help improve blood flow to the brain, allowing for better nutrient delivery and waste removal. Furthermore, Moringa Pure has anti-inflammatory effects, reducing inflammation in the brain that can negatively impact memory and cognitive function. With its potent combination of brain-boosting nutrients and protective compounds, Moringa Pure offers a natural and holistic approach to enhancing memory and focus.

In Western countries, where it's renowned for its health effects, Moringa is usually sold in powder form as a supplement.

**Ingredients:** see Supplement Facts.

**Manufacturer Country:** USA

**Product Amount:** 60 caps

**Gross Weight:** 0.25lb (113g)

**Suggested Use:** Take two (2) capsules once a day as a dietary supplement. For best results, take 20-30 min before a meal with an 8oz glass of water or as directed by your healthcare professional.

**Caution:** Do not exceed recommended dose. Pregnant or nursing mothers, children under the age of 18, and individuals with a known medical condition should consult a physician before using this or any dietary supplement.

**Warning:** Keep out of reach of children. Do not use if the safety seal is damaged or missing. Store in a cool, dry place.

The Food and Drug Administration has not evaluated these statements. This product is not intended to diagnose, treat, cure or prevent any disease.

**DrSous.Ca Moringa Pure 60 Capsules Bottle**  
Regular price: \$12.00 CAD  
Product Amount: 60 caps  
Gross Weight: 0.25lb (113g)  
Moringa Oleifera is a tree that originates from Northern India and has been praised for its health benefits for centuries. Almost all parts of the tree are used in traditional medicine, where people can expect to get a high dose of protein, Vitamin C, Vitamin B6, Riboflavin, and iron.

Amount Per Serving	% Daily Value
Moringa Oleifera (leaf)	800 mg

\*Daily Value not established.  
Inactive Ingredients: Cellulose (vegetable capsule).

131

QR codes for Paradise Wellness, Dr. Sous, and www.drsous.ca.

## 2. Neuro Plus

This supplement helps by improving mental clarity and focus, boosting intelligence levels, memory function, and increasing your level of concentration and alertness. As an added bonus, Neuro Plus can provide you with an increased level of energy and improved mood.

**Neuro Plus**  
This supplement helps by improving mental clarity and focus, boosting intelligence levels, memory function, and increasing your level of concentration and alertness. As an added bonus, Neuro Plus can provide you with an increased level of energy and improved mood.

159

QR codes for www.paradisewellness.ca, Dr. Sous, and www.drsous.ca.

## 3. Nootropic Brain & Focus

Nootropic Brain & Focus Formula combines a number of powerful amino acids such as Dimethylaminoethanol (DMAE Bitartrate), L-Glutamine, L-Tyrosine, and GABA, which enhance neuroactivity with plant extracts such as Bacopa that alter neurochemistry to improve focus, learning, and intelligence.

Keep your focus sharp and energy high with our natural Nootropic Brain and Focus Formula.

**Ingredients:** see Supplement Facts.

**Manufacturer Country:** USA

**Product Amount:** 60 caps

**Gross Weight:** 0.25lb (133g)

**Suggested Use:** As a dietary supplement, take two (2) veggie capsules once a day. For best results, take 20-30 min before a meal with an 8oz. glass of water or as directed by your healthcare professional

**Caution:** Do not exceed recommended dose. Pregnant or nursing mothers, children under the age of 18, and individuals with a known medical condition should consult a physician before using this or any dietary supplement.

**Iron Warning:** Accidental overdose of iron-containing products is a leading cause of fatal poisoning in children under 6. Call a doctor or poison control center immediately in case of accidental overdose.



#### 4. DEMENTIA

Dementia is a condition characterized by progressive or persistent loss of intellectual functioning, especially with impairment of memory and abstract thinking, and often with personality change, resulting from degenerative disease of the brain.

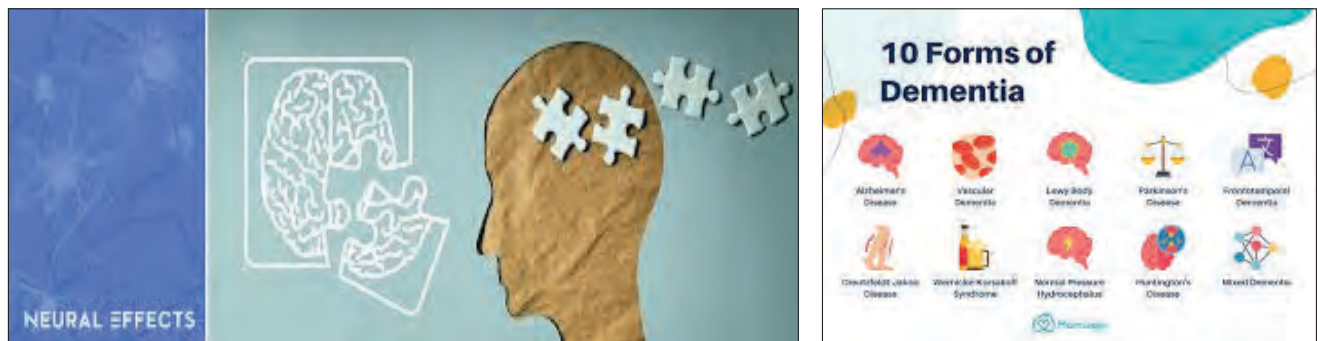

#### What is the main cause of dementia?

Alzheimer's disease accounts for 60-80% of cases. Vascular dementia, which occurs because of microscopic bleeding and blood vessel blockage in the brain, is the second most common cause of dementia. Those who experience the brain changes of multiple types of dementia simultaneously have mixed dementia.

#### # Symptoms

Dementia symptoms vary depending on the cause. Common symptoms include:

- Cognitive changes
- Memory loss, which is usually noticed by someone else.
- Problems communicating or finding words.

- Trouble with visual and spatial abilities, such as getting lost while driving.
- Problems with reasoning or problem-solving.
- Trouble performing complex tasks.
- Trouble with planning and organizing.
- Poor coordination and control of movements.
- Confusion and disorientation.

### Psychological changes

- Personality changes.
- Depression.
- Anxiety.
- Agitation.
- Inappropriate behavior.
- Being suspicious, known as paranoia.
- Seeing things that aren't there, known as hallucinations.

**The recommended supplement for Dementia are:** CoQ10, Nootropic Brain & Focus, & Ginkgo Biloba + Ginseng

### 1. CoQ10

CoQ10 Ubiquinone is found naturally in the body. However, CoQ10 levels might decrease with age, which is why it has become a popular supplement.

CoQ10 plays a crucial role in energy production and serves as a powerful antioxidant. Over the years, CoQ10 has gained attention for its potential benefits in various health conditions, including dementia. Dementia is a progressive brain disorder characterized by a decline in cognitive function, memory loss, and impaired daily activities. Research suggests that CoQ10 may have neuroprotective properties and could potentially slow down the progression of cognitive decline. Additionally, it has been proposed that CoQ10 supplementation might enhance mitochondrial function and improve energy production in brain cells, which may be beneficial for individuals with dementia. Ubiquinone also contributes to energy production. CoQ10 safeguards cells against oxidative damage. It is also essential for producing ATP, the body's major energy source.

**Ingredients:** see Supplement Facts.

**Manufacturer Country:** USA

**Product Amount:** 30 caps

**Gross Weight:** 0.25lb (113g)

**Suggested Use:** Take one (1) capsule twice a day as a dietary supplement. For best results, take 20-30 min before a meal or as directed by your healthcare professional.

**Caution:** Do not exceed recommended dose. Pregnant or nursing mothers, children under the age of 18, and individuals with a known medical condition should consult a physician before using this or any dietary supplement.

**Warning:** Keep out of reach of children. Do not use if the safety seal is damaged or missing. Store in a cool, dry place.

The Food and Drug Administration has not evaluated these statements. This product is not intended to diagnose, treat, cure or prevent any disease.



## 2. Nootropic Brain & Focus

Dementia is a progressive neurodegenerative disorder that affects cognitive abilities, memory, and overall brain function. While there is currently no cure for dementia, researchers and healthcare professionals have been exploring various strategies to support cognitive health and slow down its progression. Nootropics, also known as smart drugs or cognitive enhancers, are substances that aim to improve cognitive function, memory, concentration, and focus. Nootropic Brain & Focus Formula combines a number of powerful amino acids such as Dimethylaminoethanol (DMAE Bitartrate), L-Glutamine, L-Tyrosine, and GABA, which enhance neuroactivity with plant extracts such as Bacopa that alter neurochemistry to improve focus, learning, and intelligence. These ingredients are believed to have positive effects on brain health. When it comes to dementia, nootropics are being studied for their potential to enhance brain function, delay cognitive decline, and improve overall quality of life for those affected by this condition.

Keep your focus sharp and energy high with our natural Nootropic Brain and Focus Formula.

**Ingredients:** see Supplement Facts.

**Manufacturer Country:** USA

**Product Amount:** 60 caps

**Gross Weight:** 0.25lb (133g)

**Suggested Use:** As a dietary supplement, take two (2) veggie capsules once a day. For best results, take 20-30 min before a meal with an 8oz. glass of water or as directed by your healthcare professional

**Caution:** Do not exceed recommended dose. Pregnant or nursing mothers, children under the age of 18, and individuals with a known medical condition should consult a physician before using this or any dietary supplement.

**Iron Warning:** Accidental overdose of iron-containing products is a leading cause of fatal poisoning in children under 6. Call a doctor or poison control center immediately in case of accidental overdose.



## 3. Ginkgo Biloba + Ginseng

Ginkgo Biloba is a plant originating in Asia that was used in ancient Chinese medicine. Usually, the herb's leaves are used, but the seeds are shown to have the highest efficacy. Ginkgo contains numerous flavonoids and terpenoids, which promote blood flow in the body and brain. Ginkgo Biloba, extracted from the leaves of the Ginkgo tree, has been used in traditional medicine for centuries and is believed to enhance cognitive function. It contains compounds that act as antioxidants, reducing oxidative stress and inflammation in the brain, which are believed to contribute to the development of dementia. Additionally, Ginkgo Biloba may improve blood circulation, thereby ensuring that the brain receives an adequate supply of oxygen and nutrients. Ginseng, on the other hand, is a popular herb in traditional Chinese medicine known for its adaptogenic properties. It has been found to improve brain function, memory, and attention, which are often impaired in individuals with dementia. Ginseng contains bioactive compounds called ginsenosides, which are believed to have neuroprotective effects by reducing inflammation and protecting brain cells against damage. Moreover, both Ginkgo Biloba and Ginseng have shown promise in improving mood, reducing anxiety, and enhancing overall well-being, which can have a positive impact on individuals with dementia who often experience emotional and psychological challenges.



**Ingredients:** See Supplement Facts.

**Manufacturer Country:** USA

**Product Amount:** 60 caps

**Gross Weight:** 0.25lb (133g)

**Suggested Use:** As a dietary supplement, take two (2) capsules before bedtime or as directed by your healthcare professional.

**Warning:** Keep out of reach of children. Do not use if the safety seal is damaged or missing. Store in a cool, dry place.

The Food and Drug Administration has not evaluated these statements. This product is not intended to diagnose, treat, cure or prevent any disease.

Amount Per Serving	% DV
Red Panax Ginseng Extract (Standardized to 5% ginsenosides)	300mg **
Ginkgo Biloba Leaf Powder	500mg **
Ginkgo Biloba Leaf 24% Flavonols	120mg **

\*\* Daily Value (DV) not established.

**Other Ingredients:** Vegetable Cellulose, Vegetable Starch, Silicon Dioxide.

#### 4. ALZHEIMER'S DISEASE

Alzheimer's disease is a brain disorder that gets worse over time. It's characterized by changes in the brain that lead to deposits of certain proteins. Alzheimer's disease causes the brain to shrink and brain cells to eventually die. Alzheimer's disease is the most common cause of dementia a gradual decline in memory, thinking, behavior and social skills. These changes affect a person's ability to function.



#### # Symptoms

- Inability to communicate.
- No awareness of recent experiences or surroundings.
- Weight loss with little interest in eating.
- Seizures.
- General physical decline, including dental, skin, and foot problems.
- Difficulty swallowing.
- Groaning, moaning, or grunting.
- Increased sleeping.

The recommended supplement for Alzheimer's disease are: Platinum Turmeric, CoQ10, Ginkgo Biloba, & B-12 Drop



**Ingredients:** see Supplement Facts.

**Manufacturer Country:** USA

**Product Amount:** 30 caps

**Gross Weight:** 0.25lb (113g)

**Suggested Use:** Take one (1) capsule twice a day as a dietary supplement. For best results, take 20-30 min before a meal or as directed by your healthcare professional.

**Caution:** Do not exceed recommended dose. Pregnant or nursing mothers, children under the age of 18, and individuals with a known medical condition should consult a physician before using this or any dietary supplement.



### 3. Ginkgo Biloba + Ginseng

Ginkgo Biloba is a plant originating in Asia that was used in ancient Chinese medicine. Usually, the herb's leaves are used, but the seeds are shown to have the highest efficacy. Ginkgo contains numerous flavonoids and terpenoids, which promote blood flow in the body and brain. Ginkgo biloba is rich in antioxidants and has been traditionally used in Chinese medicine for its memory-enhancing properties. Its active compounds, such as flavonoids and terpenoids, are believed to improve blood flow to the brain, protect against oxidative stress, and reduce inflammation, all of which are factors associated with Alzheimer's disease. Ginseng, on the other hand, is a herbal root known for its adaptogenic properties. It has been used for centuries in traditional medicine to combat fatigue, enhance mental performance, and reduce the risk of age-related cognitive decline. Ginseng contains bioactive compounds called ginsenosides, which have been shown to possess antioxidant and anti-inflammatory effects, as well as the ability to modulate neurotransmitter systems in the brain.

**Ingredients:** See Supplement Facts.

**Manufacturer Country:** USA

**Product Amount:** 60 caps

**Gross Weight:** 0.25lb (133g)

**Suggested Use:** As a dietary supplement, take two (2) capsules before bedtime or as directed by your healthcare professional.

**Warning:** Keep out of reach of children. Do not use if the safety seal is damaged or missing. Store in a cool, dry place.

The Food and Drug Administration has not evaluated these statements. This product is not intended to diagnose, treat, cure or prevent any disease.



#### 4. B-12 Drops

Vitamin B-12 plays a crucial role in maintaining healthy nerve cells and producing DNA and red blood cells. It is believed that individuals with Alzheimer's disease may have lower levels of vitamin B-12, which could contribute to the progression of the disease. B-12 drops, when taken orally or sublingually, provide a convenient and easily absorbed form of the vitamin. By replenishing vitamin B-12 levels in the body, these drops aim to support brain health and potentially improve cognitive function in Alzheimer's patients.



#### 5) PARKINSON'S DISEASE

The most prominent signs and symptoms of Parkinson's disease occur when nerve cells in the basal ganglia, an area of the brain that controls movement, become impaired and/or die. Normally, these nerve cells, or neurons, produce an important brain chemical known as dopamine. When the neurons die or become impaired, they produce less dopamine, which causes movement problems associated with the disease. Scientists still do not know what causes the neurons to die.

People with Parkinson's disease also lose the nerve endings that produce norepinephrine, the main chemical messenger of the sympathetic nervous system, which controls many functions of the body, such as heart rate and blood pressure. The loss of norepinephrine might help explain some of the non-movement features of Parkinson's, such as fatigue, irregular blood pressure, decreased movement of food through the digestive tract, and sudden drop in blood pressure when a person stands up from a sitting or lying position.

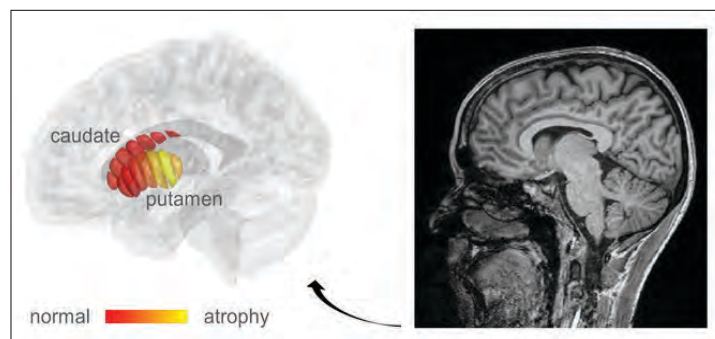

# **Symptoms:** Parkinson's has four main symptoms:

- Tremor in hands, arms, legs, jaw, or head
- Muscle stiffness, where muscle remains contracted for a long time
- Slowness of movement
- Impaired balance and coordination, sometimes leading to falls

**Other symptoms may include:**

- Depression and other emotional changes
- Difficulty swallowing, chewing, and speaking

- Urinary problems or constipation
- Skin problems

**The recommended supplement for Parkinson's disease are:** CoQ10, Sleep Well Gummies, Vitamin D3, & Nootropic Brain & Focus)

### 1. CoQ10

CoQ10, a naturally occurring compound in the body, plays a crucial role in energy production within cells and acts as a powerful antioxidant. Studies have suggested that CoQ10 supplementation may have a neuroprotective effect by reducing oxidative stress and inflammation, which are believed to contribute to the development and progression of Parkinson's disease. CoQ10 supplementation significantly slowed down the decline of functional abilities in patients with early-stage Parkinson's disease. The exact mechanisms by which CoQ10 exerts its therapeutic effects in Parkinson's disease are not yet fully understood. However, it is believed that CoQ10's ability to enhance mitochondrial function and reduce oxidative stress may contribute to its neuroprotective properties. Furthermore, CoQ10 has been shown to increase dopamine levels in the brain, which may help alleviate some of the motor symptoms associated with Parkinson's disease.

**Ingredients:** see Supplement Facts.

**Manufacturer Country:** USA

**Product Amount:** 30 caps

**Gross Weight:** 0.25lb (113g)

**Suggested Use:** Take one (1) capsule twice a day as a dietary supplement. For best results, take 20-30 min before a meal or as directed by your healthcare professional.

**Caution:** Do not exceed recommended dose. Pregnant or nursing mothers, children under the age of 18, and individuals with a known medical condition should consult a physician before using this or any dietary supplement.

**Warning:** Keep out of reach of children. Do not use if the safety seal is damaged or missing. Store in a cool, dry place.

The Food and Drug Administration has not evaluated these statements. This product is not intended to diagnose, treat, cure or prevent any disease.



### 2. Sleep Well Gummies

Sleep disturbances are a common and challenging symptom for individuals with Parkinson's disease. Fortunately, there are various approaches to managing sleep problems, and one emerging option is the use of Sleep Well Gummies specifically designed for individuals with Parkinson's disease. These gummies offer a convenient and tasty way to promote better sleep quality and alleviate the symptoms associated with sleep disturbances. Parkinson's disease often disrupts the sleep-wake cycle due to the degeneration of specific brain cells that regulate sleep. This can result in difficulties falling asleep, staying asleep, and experiencing restful sleep. Sleep Well Gummies for Parkinson's disease contain a blend of natural ingredients known for their sleep-inducing properties. For instance, melatonin, a

hormone that regulates sleep, is a key component in these gummies. It helps to regulate the sleep-wake cycle and promote a more balanced sleep pattern.

**Ingredients:** see Supplement Facts.

**Manufacturer Country:** USA

**Product Amount:** 60 gummies

**Gross Weight:** 0.56lb (255g)

**Suggested Use:** Take two (2) capsules once a day as a dietary supplement.

**Caution:** Do not exceed recommended dose. Pregnant or nursing mothers, children under the age of 18, and individuals with a known medical condition should consult a physician before using this or any dietary supplement.

**Warning:** This product is not intended to diagnose, treat, cure or prevent any disease. Keep out of reach of children. Do not use if the safety seal is damaged or missing. Store in a cool, dry place.

The Food and Drug Administration has not evaluated these statements. This product is not intended to diagnose, treat, cure or prevent any disease.

**DrSous.Ca Sleep Well Gummies (Adult)**  
 Regular price: \$23.90 CAD  
 Product Amount: 60 gummies  
 Gross Weight: 0.56lb (255g)  
 Sleep is an essential part of life and some people may have difficulty in sleeping. Sleep Well Gummies are designed to improve sleep and relaxation. It is a blend of Passiflora Incarnata & Melatonin both of which assists in enhancing the quality and amount of sleep.

**Supplement Facts**  
 Serving Size: 2 Gummies  
 Servings Per Container: 30

	Amount Per Serving	%DV*
Calories	0	0%
Total Carbohydrates	4.0g	8%
Dietary Fiber (Soluble)	2.0g	4%
Total Sugar	3.0g	6%
Total Added Sugars	3.0g	6%
Fat	0g	0%
Cholesterol	0g	0%
Vitamin B6 (as Pyridoxine HCl)	2.0mg	40%
Passiflora Extract	300mg	60%
Passiflora Incarnata (leaf)	300mg	60%
Melatonin	3mg	60%

\*Percent Daily Values are based on a diet of other people's secrets.  
 †Percent Daily Values are based on a diet of other people's secrets.  
 ©2018 Dr. Sous. All rights reserved.

Paradise Wellness | A specific channel for Sleep Well on YouTube

Dr. Sous | www.drsous.ca

### 3. Vitamin D3

Vitamin D3, also known as cholecalciferol, is a vital nutrient that plays a crucial role in bone health and immune function. However, emerging evidence indicates that it may also have a neuroprotective effect. Several studies have shown an association between low levels of vitamin D3 and an increased risk of developing Parkinson's disease. Additionally, individuals with Parkinson's disease tend to have lower levels of vitamin D3 compared to healthy individuals.

**Ingredients:** See Supplement Facts.

**Manufacturer Country:** USA

**Product Amount:** 100 Soft-gels

**Gross Weight:** 0.1lb (45g)

**Suggested Use:** As a dietary supplement, adults take one (1) soft-gel capsule daily or as directed by a health care professional. Store in a cool, dry place and away from direct light.

**DRSOUS.CA Vitamin D3 helps maintain bone density, strength and healthy cell growth**

Vitamin D3 is a fat-soluble vitamin that supports the growth and development of bones and teeth. It also plays an essential role in the functioning of the muscles and boosting energy levels in the body. The body naturally produces Vitamin D when exposed to sunlight, and you can also receive Vitamin D from some foods like oily fish. In the winter months, especially in colder regions, the body doesn't produce as much Vitamin D, which can lead to what's called 'seasonal depression.'

VITAMIN D3  
 2000 IU  
 100 Soft-gels

www.paradisewellness.ca | A specific channel for Supplements on YouTube

Dr. Sous | www.drsous.ca

#### 4. Nootropic Brain & Focus

Nootropic Brain & Focus Formula combines a number of powerful amino acids such as Dimethylaminoethanol (DMAE Bitartrate), L-Glutamine, L-Tyrosine, and GABA, which enhance neuro-activity with plant extracts such as Bacopa that alter neurochemistry to improve focus, learning, and intelligence.

Nootropics, with their ability to enhance brain function and improve focus, have emerged as a potential complementary approach for individuals with Parkinson's disease. These supplements work by targeting neurotransmitters, enzymes, and receptors in the brain, supporting healthy cognitive function and promoting neuroplasticity. By increasing the levels of neurotransmitters such as dopamine, acetylcholine, and serotonin, nootropics may help to mitigate some of the cognitive impairments associated with Parkinson's disease. Additionally, certain nootropics have been shown to have antioxidant and anti-inflammatory properties, which could potentially reduce the neurodegenerative processes occurring in the brains of individuals with Parkinson's disease.

**Ingredients:** see Supplement Facts.

**Manufacturer Country:** USA

**Product Amount:** 60 caps

**Gross Weight:** 0.25lb (133g)

**Suggested Use:** As a dietary supplement, take two (2) veggie capsules once a day. For best results, take 20-30 min before a meal with an 8oz. glass of water or as directed by your healthcare professional

**Caution:** Do not exceed recommended dose. Pregnant or nursing mothers, children under the age of 18, and individuals with a known medical condition should consult a physician before using this or any dietary supplement.

**Iron Warning:** Accidental overdose of iron-containing products is a leading cause of fatal poisoning in children under 6. Call a doctor or poison control center immediately in case of accidental overdose.



#### 6) STROKE

A stroke, sometimes called a brain attack, occurs when something blocks blood supply to part of the brain or when a blood vessel in the brain bursts. In either case, parts of the brain become damaged or die. A stroke can cause lasting brain damage, long-term disability, or even death. A stroke, also known as transient ischemic attack or cerebrovascular accident, happens when blood flow to the brain is blocked. This prevents the brain from getting oxygen and nutrients from the blood. Without oxygen and nutrients, brain cells begin to die within minutes. Sudden bleeding in the brain can also cause a stroke if it damages brain cells.

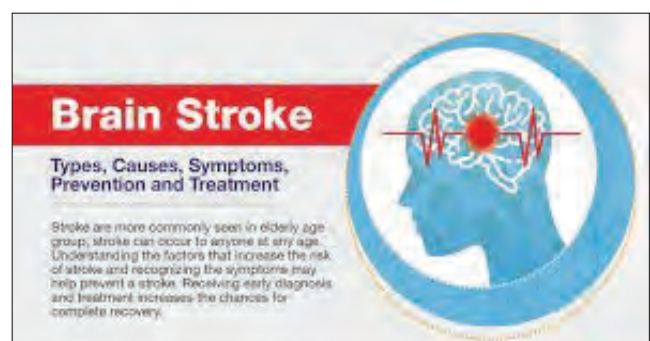

## # Symptoms

The signs and symptoms of a stroke often develop quickly. However, they can develop over hours or even days, such as when a transient ischemic attack (TIA) turns into a stroke.

The type of symptoms depends on the type of stroke and the area of the brain that is affected.

Signs of a TIA or stroke may include:

- Sudden numbness or weakness, especially on one side of the body
- Sudden confusion or trouble speaking or understanding speech
- Sudden trouble seeing in one or both eyes
- Sudden trouble walking, dizziness, or loss of balance or coordination
- Sudden severe headache with no known cause

The FAST test can help you remember what to do if you think someone may be having a stroke:

**F—Face:** Ask the person to smile. Does one side of the face droop?

**A—Arms:** Ask the person to raise both arms. Does one arm drift downward?

**S—Speech:** Ask the person to repeat a simple phrase. Is their speech slurred or strange?

**T—Time:** If you observe any of these signs, call 9-1-1 right away. Early treatment is essential.

**The recommended supplement Stroke are:** CoQ10, Platinum Turmeric, Vitamin D3

## 1. CoQ10

Stroke, is a medical emergency caused by disrupted blood flow to the brain, can lead to severe neurological damage and long-term disabilities. Research suggests that CoQ10 supplementation may have a positive impact on stroke patients by reducing oxidative stress, improving mitochondrial function, and enhancing the overall recovery process. CoQ10 possesses potent antioxidant properties, which help neutralize harmful free radicals and protect brain cells from damage. Additionally, CoQ10 plays a crucial role in energy production within the mitochondria, the powerhouses of cells. By increasing cellular energy production, CoQ10 may aid in the recovery of brain cells affected by the stroke, potentially improving neurological outcomes.

Ubiquinone also contributes to energy production. CoQ10 safeguards cells against oxidative damage. It is also essential for producing ATP, the body's major energy source.

**Ingredients:** see Supplement Facts.

**Manufacturer Country:** USA

**Product Amount:** 30 caps

**Gross Weight:** 0.25lb (113g)

**Suggested Use:** Take one (1) capsule twice a day as a dietary supplement. For best results, take 20-30 min before a meal or as directed by your healthcare professional.

**Caution:** Do not exceed recommended dose. Pregnant or nursing mothers, children under the age of 18, and individuals with a known medical condition should consult a physician before using this or any dietary supplement.

**Warning:** Keep out of reach of children. Do not use if the safety seal is damaged or missing.

Store in a cool, dry place.

The Food and Drug Administration has not evaluated these statements. This product is not intended to diagnose, treat, cure or prevent any disease.





## 2. Platinum Turmeric

Traditional treatment options for stroke focus primarily on medication, physical therapy, and rehabilitation. However, recent studies have shown that Platinum Turmeric, a potent herb known for its anti-inflammatory and antioxidant properties, can offer additional benefits in the recovery process. Curcumin, the active compound found in turmeric, has been found to possess neuroprotective properties, aiding in the prevention of further brain damage following a stroke. Furthermore, curcumin's anti-inflammatory effects can help reduce post-stroke inflammation, which is a major contributor to secondary brain injury. Additionally, Platinum Turmeric has shown promise in improving cognitive function and memory, which are often compromised in stroke patients. This herb has been found to enhance neuroplasticity, the brain's ability to adapt and reorganize itself to compensate for damaged areas. Moreover, Platinum Turmeric promotes cardiovascular health by lowering cholesterol levels, improving blood circulation, and preventing the formation of blood clots, all of which are crucial for stroke prevention and recovery.

Our Platinum Turmeric blend contains various forms of turmeric, glucosamine, Boswellia extract (frankincense), piperine, and several other highly beneficial natural extracts to keep you at your best. Natural extracts have been used for centuries in Ayurvedic medicine to remedy illnesses. We harness and advance these natural extracts in modern times for optimal bioavailability and effectiveness.

**Ingredients:** see Supplement Facts.

**Manufacturer Country:** USA

**Product Amount:** 60 caps

**Gross Weight:** 0.25lb (113g)

**Suggested Use:** Take two (2) capsules once a day as a dietary supplement. For best results, take 20-30 min before a meal or as directed by your healthcare professional.

**Caution:** Consult a physician before use if you have any medical conditions. Glucosamine is derived from shellfish. People allergic to shellfish should not consume this product.

**DrSous.ca Platinum Turmeric 60 Capsule Bottle**  
Regular price: \$20.00 CAD  
Product Amount: 60 caps  
Gross Weight: 0.25lb (113g)  
Our Platinum Turmeric blend contains various forms of turmeric, glucosamine, Boswellia extract (frankincense), piperine, and several other highly beneficial natural extracts to keep you at your best.

- Anti-inflammatory
- Joint and bone health
- Heart Protective
- Anti-oxidant & Anti-Cancer

**Supplement Facts**  
Serving Size: 2 Capsules to Maximize Your Absorption  
Amount Per Serving (%DV)  
Turmeric Root Powder (Curcumin) 800mg  
Boswellia Extract (Boswellic Acids) 100mg  
Piperine (Black Pepper) 50mg  
Glucosamine HCl (Shellfish Free) 100mg  
Chondroitin Sulfate 100mg  
MSM (Methylsulfonylmethane) 100mg  
Vitamin K2 (MK-7) 100mcg  
Vitamin D3 1000IU  
Zinc (Zinc Oxide) 100mg  
Copper (Copper Gluconate) 100mg  
Manganese (Manganese Citrate) 100mg  
\*\* Daily Value (DV) not established.

Other Ingredients: Cellulose, Hypromellose, Croscarmellose, Magnesium Stearate, Stearic Acid, and Capsule Shell.

Dr. Sous | www.drsous.ca

## 3. Vitamin D3

Studies have shown that low levels of vitamin D3 are associated with an increased risk of stroke. Adequate vitamin D3 levels have been linked to a lower incidence of ischemic stroke, the most common type of stroke caused by a blood clot obstructing a blood vessel in the brain. In addition, vitamin D3 deficiency has been associated with poorer outcomes and increased mortality in stroke patients.

Inflammation and oxidative stress play crucial roles in the progression of stroke damage, and vitamin D3 has been shown to modulate these processes. By reducing inflammation and oxidative stress, vitamin D3 may help protect brain cells from further damage and promote recovery following a stroke. Furthermore, vitamin D3 has been found to have neuroprotective effects. It has been reported to enhance the production of neurotrophic factors, which are proteins that promote the survival and growth of neurons, as well as stimulate the production of myelin, a protective substance that covers nerve fibers. These effects suggest that vitamin D3 may have the potential to support neural repair and regeneration, crucial processes for stroke recovery.

**Ingredients:** see Supplement Facts.

**Manufacturer Country:** USA

**Product Amount:** 100 soft-gels

**Gross Weight:** 0.1lb (45g)

**Suggested Use:** As a dietary supplement, adults take one (1) soft-gel capsule daily or as directed by a health care professional. Store in a cool, dry place and away from direct light.



## 7) PARESTHESIA, NUMBNESS, TINGLING

### What is paresthesia?

Paresthesia refers to a burning or prickling sensation that is usually felt in the hands, arms, legs, or feet, but can also occur in other parts of the body. The sensation, which happens without warning, is usually painless and described as tingling or numbness, skin crawling, or itching. Most people have experienced temporary paresthesia—also known as a feeling of “pins and needles”—at some time in their lives when they have sat with their legs crossed for too long or fallen asleep with an arm positioned under their head. It happens when sustained pressure is placed on a nerve. The feeling quickly goes away once the pressure is relieved.

### What is Numbness & Tingling?

Numbness (lost, reduced, or altered sensation) and tingling (an odd prickling sensation) are types of temporary paresthesia. These sensations commonly occur after sitting or standing in a particular position or even wearing tight clothing for too long. This puts pressure on nerves and blood vessels, reducing sensation. Numbness (lost, reduced, or altered sensation) and tingling (an odd prickling sensation) are types of temporary paresthesia. These sensations commonly occur after sitting or standing in a particular position or even wearing tight clothing for too long. This puts pressure on nerves and blood vessels, reducing sensation. Multiple sclerosis: Numbness and tingling are two of the most common and early symptoms of MS. MS often causes mild to severe numbness and tingling on the skin or certain parts of the body, including the:

- arms and hands
- legs and feet
- face
- body, often across the body in a band (sometimes described as an MS hug)

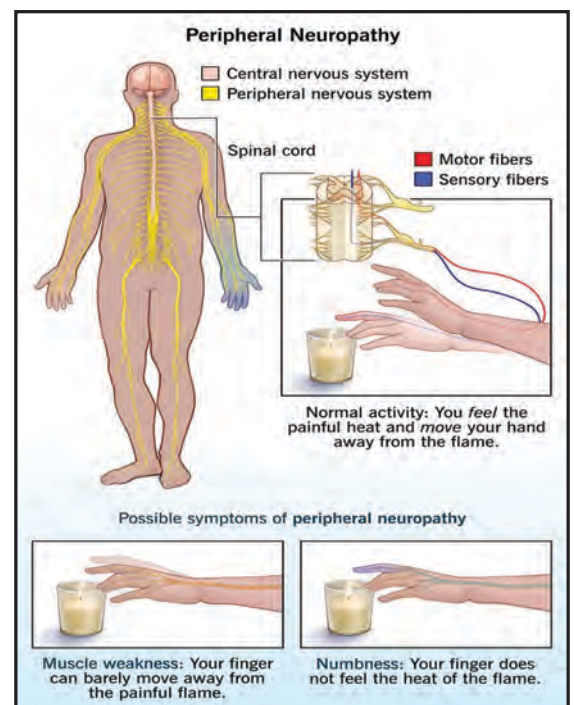

## # Symptoms

Numbness (lost, reduced, or altered sensation) and tingling (an odd prickling sensation) are types of temporary paresthesia. These sensations commonly occur after sitting or standing in a particular position or even wearing tight clothing for too long. This puts pressure on nerves and blood vessels, reducing sensation.

Numbness describes a loss of feeling in a part of the body. It also is often used to describe other changes in sensation, such as burning or a pins-and-needles feeling. Numbness can occur along a single nerve on one side of the body. Or numbness may occur on both sides of the body.

Numbness may involve the three major sensory modalities to the same or different degrees:

- Light touch
- Pain and temperature sensation
- Position and vibration sensation

**The recommended supplements for Paresthesia, Numbness, & Tingling are: B-12 Drops, Vitamin D3, Magnesium Glycinate**

### 1. B-12 Drops

Vitamin B-12, also known as cobalamin, plays a crucial role in maintaining the health of our nervous system. Paresthesia, numbness, and tingling are common symptoms experienced by individuals with a deficiency in this vital vitamin. Paresthesia refers to abnormal sensations such as tingling, prickling, or burning that are often felt in the hands, feet, legs, or arms. Numbness, on the other hand, is a lack of sensation or a reduced ability to feel touch, pressure, or temperature. These symptoms can be quite distressing and can significantly impact an individual's quality of life. Fortunately, supplementation with B-12 has been shown to be an effective treatment for these conditions.

B-12 plays a critical role in the production of myelin, a protective sheath that surrounds and insulates nerve fibers. Myelin is essential for proper nerve function, as it allows electrical impulses to travel quickly and efficiently along the nerves. When B-12 levels are low, the production of myelin is impaired, leading to nerve damage and the development of symptoms like paresthesia, numbness, and tingling.



### 2. Vitamin D3

Paresthesia refers to abnormal sensations such as prickling, tingling, or numbness that are often described as a “pins-and-needles” feeling. While there can be multiple causes for these symptoms, a deficiency in vitamin D3 has been linked to their occurrence. Vitamin D3, also known as the sunshine vitamin, is primarily synthesized in the body when the skin is exposed to sunlight. However, many people may have inadequate levels of this vital nutrient due to factors like limited sun exposure, living in areas with less sunlight, or having a diet lacking in vitamin D-rich foods. Studies have shown that vitamin D3 plays a crucial role in maintaining the health of nerves and nerve cells. It is involved in the production and maintenance of myelin, a protective covering around nerve fibers that helps facilitate the transmission of nerve signals. When there is a deficiency of vitamin D3, nerve function can be compromised, leading to

sensations of paresthesia, numbness, and tingling. Supplementing with vitamin D3 has been found to alleviate these symptoms in some cases, especially when they are related to a deficiency.

**Ingredients:** see Supplement Facts.

**Manufacturer Country:** USA

**Product Amount:** 100 soft-gels

**Gross Weight:** 0.1lb (45g)

**Suggested Use:** As a dietary supplement, adults take one (1) soft-gel capsule daily or as directed by a health care professional. Store in a cool, dry place and away from direct light.

DRSOUS.CA Vitamin D3 helps maintain bone density, strength and healthy cell growth

Vitamin D3 is a fat-soluble vitamin that supports the growth and development of bones and teeth. It also plays an essential role in the functioning of the muscles and boosting energy levels in the body. The body naturally produces Vitamin D when exposed to sunlight, and you can also receive Vitamin D from some foods like oily fish. In the winter months, especially in colder regions, the body doesn't produce as much Vitamin D, which can lead to what's called 'seasonal depression.'

www.paradisewellness.ca A specific channel for Supplements on YouTube

Dr. Sous | www.drsous.ca

154

### 3. Magnesium Glycinate

Magnesium is an essential mineral that plays a crucial role in the proper functioning of the nervous system. It is involved in nerve transmission and muscle contraction, making it a key component in maintaining healthy nerve function. Magnesium Glycinate is a form of magnesium that is highly bioavailable and well-tolerated by the body. This means that it is easily absorbed and utilized, leading to better overall efficacy. Studies have suggested that magnesium deficiency may contribute to the development of paresthesia symptoms. Therefore, supplementing with magnesium, particularly in the form of Magnesium Glycinate, may help alleviate these symptoms. Additionally, magnesium is known to have a calming effect on the nervous system, which can further aid in reducing the sensations of numbness and tingling.

Magnesium Glycinate is one of the most important nutrient for natural sleep cycle, to help calm the brain, to help the body relax and fall and stay asleep. By doing this the body is able to be rejuvenated.

Magnesium Glycinate

Magnesium Glycinate is one of the most important nutrients needed throughout the body. It is most commonly used as a natural sleep vitamin that helps calm the brain, to help the body relax and fall and stay asleep. By doing this, the body is able to be rejuvenated.

www.paradisewellness.ca A specific channel for Supplements on YouTube

Dr. Sous | www.drsous.ca

160

## 8) COLD HANDS

Raynaud's disease causes some areas of the body such as fingers and toes to feel numb and cold in response to cold temperatures or stress. In Raynaud's disease, smaller arteries that supply blood to the skin narrow. This limits blood flow to affected areas, which is called vasospasm.

It's common to have cold hands even when you're not in a cold environment. Usually, having cold hands is just one of the ways the body tries to control its temperature and shouldn't be cause for concern. However, persistently cold hands particularly with skin color changes could be a warning sign of nerve damage, blood flow problems, or tissue damage in the hands or fingers.



**The recommended supplement for Cold Hands are:** Ginkgo Biloba + Ginseng, B-12 Drops, CoQ10, & Neuro Plus

### 1. Ginkgo Biloba + Ginseng

Ginkgo Biloba is a plant originating in Asia that was used in ancient Chinese medicine. Usually, the herb's leaves are used, but the seeds are shown to have the highest efficacy. Ginkgo contains numerous flavonoids and terpenoids, which promote blood flow in the body and brain.

Cold hands can be a common symptom caused by poor circulation or restricted blood flow to the extremities. Ginkgo Biloba, derived has been studied for its potential to improve blood circulation and enhance peripheral vasodilation. It contains compounds called flavonoids and terpenoids, which have antioxidant properties and can help relax blood vessels, promoting better blood flow to the hands. Ginseng, on the other hand, is a root plant known for its adaptogenic properties and ability to improve overall well-being. It has been traditionally used to enhance vitality and circulation. By stimulating the release of nitric oxide, ginseng can help relax blood vessels, allowing for improved blood flow to the extremities. When taken together, Ginkgo Biloba and Ginseng can potentially complement each other's effects, providing a synergistic approach to addressing cold hands.

**Ingredients:** See Supplement Facts.

**Manufacturer Country:** USA

**Product Amount:** 60 caps

**Gross Weight:** 0.25lb (133g)

**Suggested Use:** As a dietary supplement, take two (2) capsules before bedtime or as directed by your healthcare professional.

**Warning:** Keep out of reach of children. Do not use if the safety seal is damaged or missing. Store in a cool, dry place.

The Food and Drug Administration has not evaluated these statements. This product is not intended to diagnose, treat, cure or prevent any disease.

**DrSous.Ca Ginkgo Biloba + Ginseng**  
Regular price: \$29.00 CAD  
Product Amount: 60 caps  
Gross Weight: 0.25lb (133g)  
Ginkgo Biloba is a herb used in ancient Chinese medicine for its effective antioxidant properties. Ginkgo Biloba is one of the oldest and most-commonly-used brain supplement for better mental function. Combine it with Ginseng for benefits to blood flow, oxygen, nutrient absorption in the brain & to strengthen the immune system.

- Anti-aging
- Helps to combat cold and flu symptoms.
- Improved memory and cognition
- Strong antioxidant

	Amount Per Serving	% DV
Red Panax Ginseng Extract (Standardized to 70% Ginsenosides/UGS)	300mg	100%
Ginkgo Biloba Leaf Powder	600mg	100%
Ginkgo Biloba Leaf 24% Flavonoids	120mg	100%

\*\* Daily Value (DV) not established

Other Ingredients: Vegetable Cellulose, Vegetable Stearate, Silicon Dioxide

118

A specific channel for Ginkgo Biloba on YouTube

Paradise Wellness | Dr. Sous | www.drsous.ca

## 2. B-12 Drops

B-12, also known as vitamin B12, is a crucial nutrient that plays a significant role in maintaining the overall health and well-being of individuals. While its benefits are vast, one intriguing aspect of B-12 is its potential to alleviate the issue of cold hands. Cold hands can be a common problem for many people, particularly during the colder months or in individuals with poor circulation. B-12 is known to support healthy blood circulation, which can help address this issue. By promoting the production of red blood cells, B-12 aids in carrying oxygen to various parts of the body, including the extremities. This increased oxygen supply can help warm up cold hands by improving blood flow and reducing the constriction of blood vessels. Additionally, B-12 is involved in maintaining a healthy nervous system, which plays a crucial role in regulating body temperature. By supporting nerve function, B-12 may contribute to a more efficient thermoregulation process, reducing the occurrence of cold hands.



## 3. CoQ10

CoQ10, also known as Coenzyme Q10, is a naturally occurring substance in the body that plays a crucial role in cellular energy production. While it is primarily known for its benefits to heart health, recent research suggests that CoQ10 may also have positive effects on circulation, making it a potential remedy for cold hands. Cold hands, medically known as Raynaud's phenomenon, is a condition characterized by the narrowing of blood vessels in the extremities, leading to reduced blood flow and coldness in the hands. By boosting energy production at a cellular level, CoQ10 may improve blood flow and circulation, thereby alleviating the symptoms associated with cold hands. Furthermore, CoQ10 is a potent antioxidant that helps protect the cells from oxidative damage, which can contribute to the development or worsening of Raynaud's phenomenon.

Ubiquinone also contributes to energy production. CoQ10 safeguards cells against oxidative damage. It is also essential for producing ATP, the body's major energy source.

**Ingredients:** see Supplement Facts.

**Manufacturer Country:** USA

**Product Amount:** 30 caps

**Gross Weight:** 0.25lb (113g)

**Suggested Use:** Take one (1) capsule twice a day as a dietary supplement. For best results, take 20-30 min before a meal or as directed by your healthcare professional.

**Caution:** Do not exceed recommended dose. Pregnant or nursing mothers, children under the age of 18, and individuals with a known medical condition should consult a physician before using this or any dietary supplement.

**Warning:** Keep out of reach of children. Do not use if the safety seal is damaged or missing. Store in a cool, dry place.

The Food and Drug Administration has not evaluated these statements. This product is not intended to diagnose, treat, cure or prevent any disease.



#### 4. Neuro Plus

Neuro Plus offers a unique blend of ingredients specifically formulated to improve blood circulation and promote warmth in the extremities. This supplement contains a combination of vitamins, minerals, and herbal extracts that work synergistically to enhance blood flow and support healthy vasodilation. One of the key components of Neuro Plus is L-arginine, an amino acid that is known for its vasodilatory effects. By relaxing and widening the blood vessels, L-arginine helps to improve blood flow to the hands, thereby alleviating coldness. Additionally, Neuro Plus contains other beneficial ingredients such as ginger extract, ginkgo biloba, and vitamin E, all of which have been scientifically proven to support circulatory health. Ginger extract possesses warming properties and can enhance blood circulation, while ginkgo biloba is known for its ability to improve blood flow to the extremities. Vitamin E is an antioxidant that helps protect blood vessels and promotes overall vascular health. With regular consumption of Neuro Plus, individuals with cold hands can experience significant relief and enjoy a more comfortable daily life.



#### 9) CARPAL TUNNEL

Carpal tunnel syndrome (CTS) is a common neurological disorder that occurs when the median nerve, which runs from your forearm into the palm of the hand, becomes pressed or squeezed at the wrist. You may feel numbness, weakness, pain in your hand and wrist, and your fingers may become swollen and useless. Carpal tunnel syndrome is caused by pressure on the median nerve. The carpal tunnel is a narrow passageway surrounded by bones and ligaments on the palm side of the hand. When the median nerve is compressed, symptoms can include numbness, tingling, and weakness in the hand and arm. The anatomy of the wrist, health problems and possibly repetitive hand motions can contribute to carpal tunnel syndrome.

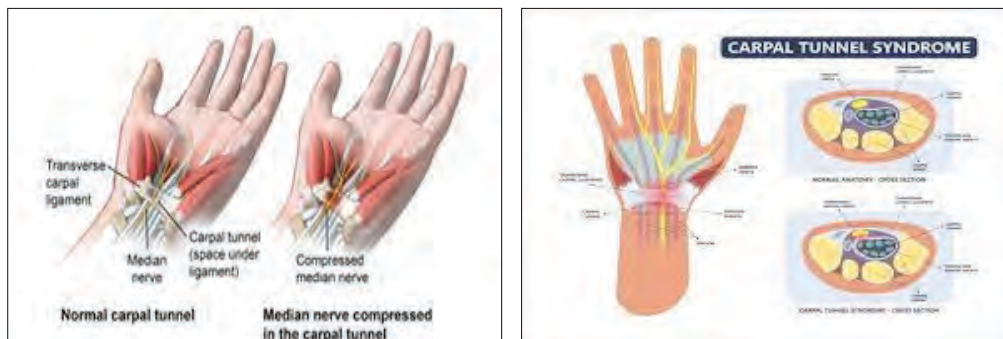

Proper treatment usually relieves the tingling and numbness and restores wrist and hand function.

#### # Symptoms

Carpal tunnel syndrome symptoms usually start gradually and include:

**Tingling or numbness.** You may notice tingling and numbness in the fingers or hand. Usually the thumb and index, middle or ring fingers are affected, but not the little finger. You might feel a sensation like an electric shock in these fingers. The sensation may travel from the wrist up the arm. These symptoms often occur while holding a steering wheel, phone or newspaper, or may wake you from sleep.

Many people “shake out” their hands to try to relieve their symptoms. The numb feeling may become constant over time.

**Weakness.** You may experience weakness in the hand and drop objects. This may be due to the numbness in the hand or weakness of the thumb’s pinching muscles, which are also controlled by the median nerve.

**The recommended supplement for Carpal Tunnel:** Platinum Turmeric, Magnesium Glycinate, & Neuro Plus

### 1. Platinum Turmeric

Carpal tunnel syndrome is a common condition characterized by pain, numbness, and tingling in the hand and arm caused by compression of the median nerve in the wrist. Traditional treatment options include medication, splinting, and surgery, but many individuals seek alternative solutions to manage their symptoms. Platinum Turmeric blend, a combination of turmeric and other herbal ingredients, has emerged as a promising option due to its potential anti-inflammatory and analgesic properties. Turmeric, a spice commonly used in traditional medicine, contains a compound called curcumin, which has been shown to possess strong anti-inflammatory effects. By reducing inflammation, the Platinum Turmeric blend may help alleviate the symptoms associated with carpal tunnel syndrome. Additionally, turmeric’s antioxidant properties can potentially protect nerve cells from damage.

Our Platinum Turmeric blend contains various forms of turmeric, glucosamine, Boswellia extract (frankincense), piperine, and several other highly beneficial natural extracts to keep you at your best.

Natural extracts have been used for centuries in Ayurvedic medicine to remedy illnesses. We harness and advance these natural extracts in modern times for optimal bioavailability and effectiveness.

**Ingredients:** see Supplement Facts.

**Manufacturer Country:** USA

**Product Amount:** 60 caps

**Gross Weight:** 0.25lb (113g)

**Suggested Use:** Take two (2) capsules once a day as a dietary supplement. For best results, take 20-30 min before a meal or as directed by your healthcare professional.

**DrSous.Ca Platinum Turmeric 60**  
**Capsule Bottle**  
Regular price: \$20.00 CAD  
Product Amount: 60 caps  
Gross Weight: 0.25lb (113g)  
Our Platinum Turmeric blend contains various forms of turmeric, glucosamine, Boswellia extract (frankincense), piperine, and several other highly beneficial natural extracts to keep you at your best.

- Anti-inflammatory
- Joint and bone health
- Heart Protective
- Anti-oxidant & Anti- Cancer

**Supplement Facts**  
Serving Size: 2 Capsules  
Amount Per Serving  
Amount Per Serving % Daily Value  
Curcumin (from Curcuma longa) 1000mg 20000%  
Glucosamine HCl 500mg 10000%  
Boswellia Extract (from Boswellia serrata) 1000mg 20000%  
Piperine 500mg 10000%  
Turmeric Root Extract (from Curcuma longa) 1000mg 20000%  
Black Pepper Extract (from Piper nigrum) 500mg 10000%  
Other Ingredients: Cellulose, Magnesium Stearate, Hydroxypropyl Methylcellulose, Croscarmellose, Polyethylene Glycol, and Natural Flavors.

Paradise Wellness  
A specific channel for Platinum Turmeric on YourTuba

Dr. Sous  
www.drsous.ca

### 2. Magnesium Glycinate

Magnesium is an essential mineral that plays a vital role in numerous bodily functions, including nerve function and muscle relaxation. Glycinate is a form of magnesium, meaning it is bound to the amino acid glycine, which enhances its absorption and bioavailability. Studies have shown that magnesium supplementation may help alleviate the symptoms associated with carpal tunnel syndrome by reducing inflammation, relaxing muscles, and improving nerve function. Additionally, magnesium has been recognized for its ability to promote sleep quality and reduce stress, both of which can contribute to overall pain management. It is most commonly used as a natural sleep vitamin that helps calm the brain, to help the body relax and fall and stay asleep. By doing this the body is able to be



rejuvenated



### 3. Neuro Plus

Neuro Plus supplement, formulated with a blend of natural ingredients known for their neuroprotective and anti-inflammatory properties, aims to alleviate the symptoms associated with CTS. The supplement contains key ingredients like turmeric, which has been shown to reduce inflammation, and vitamin B6, which supports nerve health and function. By targeting the underlying causes of CTS, Neuro Plus supplement may help reduce inflammation, relieve pain, and improve overall nerve health. Additionally, the supplement's unique formulation includes antioxidants that protect against oxidative stress, which can further damage nerves in individuals with CTS. Neuro Plus supplement offers a non-invasive and potentially effective alternative to traditional treatment methods for CTS, such as surgery or corticosteroid injections. As an added bonus, Neuro Plus can provide you with an increased level of energy and improved mood.



### 10) THORACIC OUTLET SYNDROME (TOS)

Thoracic outlet syndrome (TOS) is a group of disorders that occur when blood vessels or nerves in the space between your collarbone and your first rib (thoracic outlet) are compressed. This can cause shoulder and neck pain and numbness in your fingers.



## What are the types of thoracic outlet syndrome?

Neurogenic TOS occurs when the nerves leading from the neck to the arm (the brachial plexus) is compressed. More than 90 percent of cases are neurogenic. Venous TOS occurs when a vein is compressed, leading to swelling in the arms on the affected side. Five percent of cases are venous. Arterial TOS occurs when an artery is compressed it leads to numbness, tingling, and paresthesia on the affected side. Sometimes, the venous and arterial syndromes are known together as vascular thoracic outlet syndrome.

## # Symptoms

Thoracic outlet syndrome symptoms can vary depending on the type. When nerves are compressed, signs and symptoms of neurogenic thoracic outlet syndrome include:

- Numbness or tingling in your arm or fingers
- Pain or aches in your neck, shoulder, arm or hand
- Weakening grip

## Signs and symptoms of venous thoracic outlet syndrome can include:

- Discoloration of your hand (bluish color)
- Arm pain and swelling
- Blood clot in veins in the upper area of your body
- Arm fatigue with activity
- Paleness or abnormal color in one or more fingers or your hand
- Throbbing lump near your collarbone
- Cold fingers, hands or arms
- Hand and arm pain
- Lack of color (pallor) or bluish discoloration (cyanosis) in one or more of your fingers or your entire hand
- Weak or no pulse in the affected arm

**The recommended supplement for Thoracic Outlet Syndrome are:** Platinum Turmeric, Magnesium Glycinate, Nootropic Brain & Focus

### 1. Platinum Turmeric

Platinum turmeric, a specialized form of turmeric, which has higher concentration of curcumin, making it more potent and effective in reducing inflammation and relieving pain associated with TOS. It is believed that the anti-inflammatory properties of platinum turmeric may help reduce the compression on the nerves and blood vessels in the thoracic outlet, thereby alleviating the symptoms of TOS. Additionally, Dr. Sous Platinum Turmeric incorporates other essential nutrients, such as glucosamine, piperine, Boswellia extract (frankincense), and several other extremely advantageous natural extracts. Black pepper's main element, piperine, has been demonstrated to block a process in your body that removes compounds like curcuminoids, promoting improved absorption.

Natural extracts have been used for centuries in Ayurvedic medicine to remedy illnesses. We harness and advance these natural extracts in modern times for optimal bioavailability and effectiveness.

**Ingredients:** see Supplement Facts.

**Manufacturer Country:** USA

**Product Amount:** 60 caps

**Gross Weight:** 0.25lb (113g)

**Suggested Use:** Take two (2) capsules once a day as a dietary supplement. For best results, take 20-30 min before a meal or as directed by your healthcare professional.

**DrSous.Ca Platinum Turmeric 60**  
**Capsule Bottle**  
Regular price: \$20.00 CAD  
Product Amount: 60 caps  
Gross Weight: 0.25lb (113g)

Our Platinum Turmeric blend contains various forms of turmeric, glucosamine, Boswellia extract (frankincense), piperine, and several other highly beneficial natural extracts to keep you at your best.

- Anti-inflammatory
- Joint and bone health
- Heart Protective
- Anti-oxidant & Anti- Cancer

142

**Supplement Facts**  
Serving Size: 2 Capsules  
Amount Per Container (60 Capsules)

	Amount Per Serving (2 Caps)	% Daily Value*
Platinum Turmeric (Curcumin)	600mg	120%
Black Pepper (Piperine)	50mg	100%
Boswellia Extract (Frankincense)	100mg	100%
Glucosamine HCl	500mg	100%
Chondroitin Sulfate	400mg	100%
MSM	100mg	100%
Other Ingredients: Cellulose, Magnesium Capsulate, Non-Pare, Croscarmellose, Stearic Acid, and Titanium Dioxide.		

\*% Daily Value (DV) are estimated.

Other Ingredients: Cellulose, Magnesium Capsulate, Non-Pare, Croscarmellose, Stearic Acid, and Titanium Dioxide.

Dr. Sous | www.drsous.ca

## 2. Magnesium Glycinate

Magnesium Glycinate is a form of magnesium that is highly bioavailable and easily absorbed by the body. Magnesium itself is an essential mineral that plays a crucial role in various bodily functions, including muscle and nerve function, blood pressure regulation, and energy production. Studies have suggested that magnesium deficiency may contribute to muscle pain and spasms, which are common symptoms in individuals with TOS. By supplementing with Magnesium Glycinate, individuals with TOS may potentially experience a reduction in muscle pain and spasms, as well as improved nerve function. Furthermore, Magnesium Glycinate has been shown to have a calming effect on the nervous system, which may help alleviate the stress and anxiety that often accompany TOS. Additionally it is also used as a natural sleep vitamin that helps calm the brain, to help the body relax and fall and stay asleep. By doing this the body is able to be rejuvenated.



## 3. Nootropic Brain & Focus

Nootropic Brain & Focus Formula contains a blend of amino acids, including Dimethylaminoethanol (DMAE Bitartrate), L-Glutamine, L-Tyrosine, and GABA. These amino acids play crucial roles in neurotransmitter synthesis and brain health. DMAE Bitartrate is known for its potential to improve memory and cognitive function by increasing acetylcholine levels in the brain. While Nootropic Brain & Focus Formula is primarily designed to support cognitive function, it may also have potential benefits for individuals with thoracic outlet syndrome. This condition involves compression of nerves or blood vessels in the thoracic outlet, leading to symptoms such as pain, numbness, and weakness in the upper extremities. Although the direct effects of this nootropic formula on thoracic outlet syndrome have not been extensively studied, some of its ingredients, such as L-Glutamine and L-Tyrosine, have been associated with reducing inflammation and supporting overall nerve health. As a result, individuals with thoracic outlet syndrome may experience some relief from their symptoms when using Nootropic Brain & Focus Formula.

**Ingredients:** see Supplement Facts.

**Manufacturer Country:** USA

**Product Amount:** 60 caps

**Gross Weight:** 0.25lb (133g)

**Suggested Use:** As a dietary supplement, take two (2) veggie capsules once a day. For best results, take 20-30 min before a meal with an 8oz. glass of water or as directed by your healthcare professional

**Caution:** Do not exceed recommended dose. Pregnant or nursing mothers, children under the age of 18, and individuals with a known medical condition should consult a physician before using this or any dietary supplement.

**Iron Warning:** Accidental overdose of iron-containing products is a leading cause of fatal poisoning in children under 6. Call a doctor or poison control center immediately in case of accidental overdose.



## CHAPTER III. BLOOD, HEART & CHOLESTEROL

Cholesterol is a waxy substance found in your blood. Your body needs cholesterol to build healthy cells, but high levels of cholesterol can increase your risk of heart disease. With high cholesterol, you can develop fatty deposits in your blood vessels.

Cholesterol is carried through your blood, attached to proteins. This combination of proteins and cholesterol is called a lipoprotein. There are different types of cholesterol, based on what the lipoprotein carries. They are:

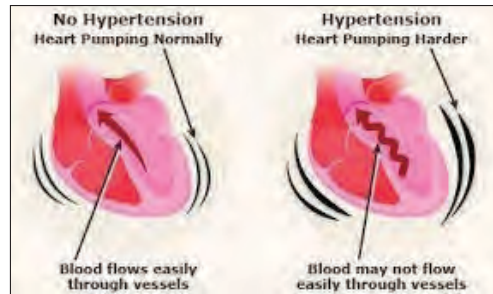

**Low-density lipoprotein (LDL).** LDL, the “bad” cholesterol, transports cholesterol particles throughout your body. LDL cholesterol builds up in the walls of your arteries, making them hard and narrow.

**High-density lipoprotein (HDL).** HDL, the “good” cholesterol, picks up excess cholesterol and takes it back to your liver.

### What are the 5 signs of high cholesterol?

6 Subtle Signs Your Body Shows When Your Cholesterol is Too High

- Heart attack. As you know, a cholesterol problem is going to bring on heart problems.
- High Blood Pressure. High blood pressure is a sign to look out for, too.
- Diabetes.
- Chest pain or angina.
- Stroke.
- Pain while walking.

### Risk factors

Factors that can increase your risk of unhealthy cholesterol levels include:

**Poor diet.** Eating too much-saturated fat or trans fats can result in unhealthy cholesterol levels. Saturated fats are found in fatty cuts of meat and full-fat dairy products. Trans fats are often found in packaged snacks or desserts.

**Obesity.** Having a body mass index (BMI) of 30 or greater puts you at risk of high cholesterol.

**Lack of exercise.** Exercise helps boost your body’s HDL, the “good,” cholesterol.

**Smoking.** Cigarette smoking may lower your level of HDL, the “good,” cholesterol.

**Alcohol.** Drinking too much alcohol can increase your total cholesterol level.

**Age.** Even young children can have unhealthy cholesterol, but it’s much more common in people over 40. As you age, your liver becomes less able to remove LDL cholesterol.

### 1) HIGH BLOOD PRESSURE

High blood pressure is a common condition that affects the body’s arteries. It’s also called hypertension. If you have high blood pressure, the force of the blood pushing against the artery walls is consistently too high. The heart has to work harder to pump blood.

Blood pressure is measured in millimeters of mercury (mm Hg). In general, hypertension is a blood pressure reading of 130/80 millimeters of mercury (mm Hg) or higher. The American College of Cardiology and the American Heart Association divide blood pressure into four general categories. Ideal blood pressure is categorized as normal. Normal blood pressure. Blood pressure is 120/80 mm Hg or lower. Blood pressure higher than 180/120 mm Hg is considered a hypertensive emergency or crisis. Seek emergency medical help

for anyone with these blood pressure numbers. Untreated, high blood pressure increases the risk of heart attack, stroke and other serious health problems. It's important to have your blood pressure checked at least every two years starting at age 18. Some people need more-frequent checks.

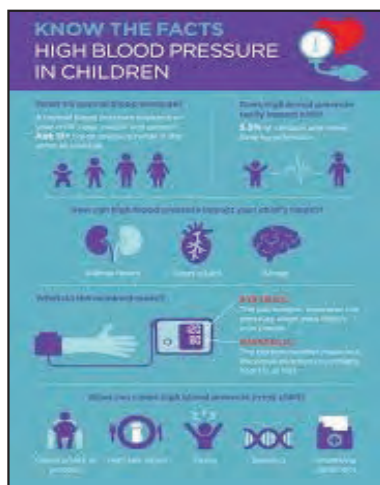

Healthy lifestyle habits —such as not smoking, exercising and eating well — can help prevent and treat high blood pressure. Some people need medicine to treat high blood pressure.

### # Symptoms

Most people with high blood pressure have no symptoms, even if blood pressure readings reach dangerously high levels. You can have high blood pressure for years without any symptoms.

A few people with high blood pressure may have:

- Headaches
- Shortness of breath
- Nosebleeds

However, these symptoms aren't specific. They usually don't occur until high blood pressure has reached a severe or life-threatening stage.

**The recommended supplement for High Blood Pressure:** Bone & Heart Support, CoQ10, Magnesium Glycinate

### 1. Bone & Heart Support

Bone & Heart Support supplement with calcium, D3, and K2 is a remarkable solution that targets two important aspects of our health: bone strength and heart support. This supplement is specifically designed to assist individuals who are dealing with high cholesterol and blood pressure issues. Calcium is a crucial mineral for maintaining healthy bones and teeth, while also playing a significant role in blood clotting, muscle function, and nerve transmission. By including calcium in this supplement, it ensures that the body receives an adequate amount to support bone health, especially for those who may not obtain enough calcium from their regular diet. Additionally, the inclusion of Vitamin D3 and K2 in this supplement further enhances its effectiveness. Vitamin D3 is essential for the absorption of calcium in the body, promoting healthy bones and teeth. It also plays a vital role in supporting the immune system and overall well-being. Vitamin K2, on the other hand, directs calcium to the bones and teeth, preventing it from accumulating in the arteries and reducing the risk of calcification. This is particularly important for individuals with high cholesterol and blood pressure, as it helps maintain cardiovascular health by ensuring that calcium is properly utilized and distributed. By combining these key ingredients, the Bone & Heart Support supplement provides a comprehensive solution for individuals seeking to improve their bone strength and support their heart health, specifically targeting those with high cholesterol and blood pressure concerns.

**Ingredients:** see Supplement Facts.

**Manufacturer Country:** USA

**Product Amount:** 60 caps

**Gross Weight:** 0.25lb (113g)

**Suggested Use:** Take one (1) capsule twice a day as a dietary supplement. For best results, take 20-30 min before a meal or as directed by your healthcare professional.

**Caution:** Do not exceed recommended dose. Pregnant or nursing mothers, children under the age of 18, and individuals with a known medical condition should consult a physician before using this or any dietary supplement.

**Warning:** Keep out of reach of children. Do not use if the safety seal is damaged or missing. Store in a cool, dry place.

The Food and Drug Administration has not evaluated these statements. This product is not intended to diagnose, treat, cure or prevent any disease.

**DrSous.ca Bone & Heart Support**  
Regular price: \$28.00 CAD  
Product Amount: 60 caps  
Gross Weight: 0.25lb (113g)  
Bone and Heart Support is a blend of Vitamin D3 and K2 essential for regulating calcium absorption in the body for stronger and healthier bones. Both vitamins D3 and K2 are essential to the body's function and overall health.  
They both help to:  
• Increases blood flow  
• Promotes healthy bones and joints  
• Improves cardiovascular health  
• Suitable for use during pregnancy

Amount Per Serving	%DV
Calcium (As Calcium Carbonate)	210 mg 10%
Vitamin D3 (Ergocalciferol)	125 mcg 0.25%
Vitamin K2 (as Menaquinone)	100 mcg
Biotin (as Biotin Fatty Acid Ester)	5 mg

1 Daily Value (DV) not established  
Other Ingredients: Cellulose (vegetable capsule)

QR codes for: Paradise Wellness, Dr. Sous, www.drSous.ca

## 2. CoQ10

CoQ10, also known as Ubiquinone, has gained significant attention in recent years for its potential benefits in managing high cholesterol and blood pressure. CoQ10 is a naturally occurring compound found in every cell of the body, playing a crucial role in energy production. It acts as an antioxidant, protecting cells from damage caused by harmful free radicals. High cholesterol and blood pressure are two common health concerns that can have serious implications if left unmanaged. Research suggests that CoQ10 supplementation may help address these issues by supporting cardiovascular health. In terms of cholesterol management, CoQ10 has been found to reduce LDL (bad) cholesterol levels while increasing HDL (good) cholesterol. This can help maintain a healthy lipid profile and reduce the risk of cardiovascular diseases. Additionally, CoQ10 has shown promise in regulating blood pressure. It helps relax blood vessels, promoting better blood flow and reducing hypertension. Moreover, CoQ10 also enhances the production of nitric oxide, a molecule that dilates blood vessels and improves endothelial function. This can further contribute to maintaining optimal blood pressure levels. While CoQ10 is naturally produced by the body, its production tends to decline with age. Therefore, supplementation may be beneficial, especially for individuals with high cholesterol or blood pressure concerns.

**Ingredients:** see Supplement Facts.

**Manufacturer Country:** USA

**Product Amount:** 30 caps

**Gross Weight:** 0.25lb (113g)

**Suggested Use:** Take one (1) capsule twice a day as a dietary supplement. For best results, take 20-30 min before a meal or as directed by your healthcare professional.

**Caution:** Do not exceed recommended dose. Pregnant or nursing mothers, children under the age of 18, and individuals with a known medical condition should consult a physician before using this or any dietary supplement.

**Warning:** Keep out of reach of children. Do not use if the safety seal is damaged or missing. Store in a cool, dry place.

**DRSOUS.CA CoQ10 Ubiquinone energy production source supplement 30 Capsules**  
Regular price: \$24.00 CAD  
Amount: 30 caps  
Gross Weight: 0.25lb (113g)  
Coenzyme Q10 (CoQ10) is an antioxidant and vitamin-like compound that is found naturally in the body and in some foods like oily fish (salmon and tuna) and organ meats (liver).

Amount Per Serving	%DV
Coenzyme Q-10 (Ubiquinone)	200mg **

\*\* Daily Value (DV) not established  
Inactive Ingredients: Cellulose (Vegetable Capsule), Rice Flour.

QR codes for: www.paradisewellness.ca, Dr. Sous, www.drSous.ca

The Food and Drug Administration has not evaluated these statements. This product is not intended to diagnose, treat, cure or prevent any disease.

### 3. Magnesium Glycinate

High blood pressure, or hypertension, is a common condition that affects millions of people worldwide and is associated with an increased risk of heart disease and stroke. Magnesium is an essential mineral that plays a crucial role in numerous bodily functions, including blood pressure regulation. Magnesium Glycinate is a form of magnesium that is highly bioavailable, meaning it is easily absorbed by the body. It has been suggested that this specific form of magnesium may have a greater impact on blood pressure compared to other forms. Several studies have explored the potential benefits of Magnesium Glycinate supplementation on blood pressure levels. These studies have shown promising results, indicating that it may help lower blood pressure in individuals with hypertension. Magnesium Glycinate is believed to work by relaxing the blood vessels, thus reducing resistance to blood flow and subsequently lowering blood pressure. Furthermore, it has been found to improve endothelial function, which is essential for maintaining healthy blood vessels.



### 2) LOW BLOOD PRESSURE

Low blood pressure is generally considered a blood pressure reading lower than 90 millimeters of mercury (mm Hg) for the top number (systolic) or 60 mm Hg for the bottom number (diastolic). What's considered low blood pressure for one person might be OK for someone else. Low blood pressure might cause no noticeable symptoms, or it might cause dizziness and fainting. Sometimes, low blood pressure can be life-threatening.

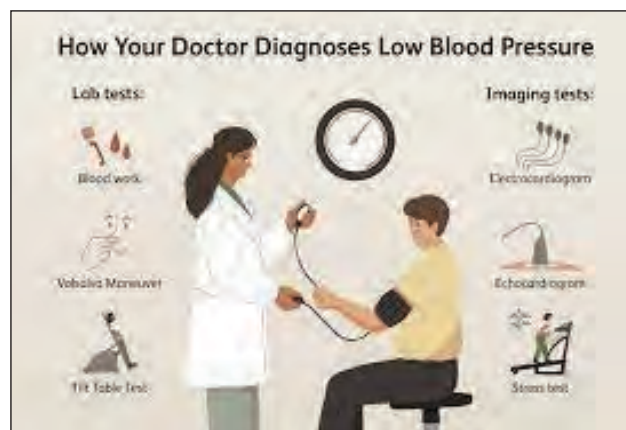

The causes of low blood pressure range from dehydration to serious medical conditions. It's important to find out what's causing low blood pressure so that it can be treated, if necessary.

**Types of low blood pressure include:**

**Orthostatic hypotension (postural hypotension).** This is a sudden drop in blood pressure when standing from a sitting position or after lying down. Causes include dehydration, long-term bed rest, pregnancy, certain medical conditions and some medications. This type of low blood pressure is common in older adults.

**Postprandial hypotension.** This drop in blood pressure occurs 1 to 2 hours after eating. It's most likely to affect older adults, especially those with high blood pressure or autonomic nervous system diseases such as Parkinson's disease. Eating small, low-carbohydrate meals, drinking more water, and avoiding alcohol might help reduce symptoms.

**Neurally mediated hypotension.** This is a blood pressure drop that happens after standing for long periods. This type of low blood pressure mostly affects young adults and children. It might result from miscommunication between the heart and the brain.

**Multiple system atrophy with orthostatic hypotension.** Also called Shy-Drager syndrome, this rare disorder affects the nervous system that controls involuntary functions such as blood pressure, heart rate, breathing and digestion. It's associated with having very high blood pressure while lying down.

### # Symptoms

Low blood pressure (hypotension) symptoms may include:

- Blurred or fading vision
- Dizziness or lightheadedness
- Fainting
- Fatigue
- Trouble concentrating
- Nausea

For some people, low blood pressure may be a sign of an underlying health condition, especially when it drops suddenly or occurs with symptoms.

A sudden fall in blood pressure can be dangerous. A change of just 20 mm Hg, a drop from 110 mm Hg systolic to 90 mm Hg systolic, for example — can cause dizziness and fainting. And big drops, such as those caused by uncontrolled bleeding, severe infections or allergic reactions, can be life-threatening.

Extreme low blood pressure can lead to a condition known as shock. Symptoms of shock include:

- Confusion, especially in older people
- Cold, clammy skin
- Decrease in skin coloration (pallor)
- Rapid, shallow breathing
- Weak and rapid pulse

**The recommended supplements for Low Blood Pressure are:**

Beetroot Powder, CoQ10, Magnesium Glycinate)

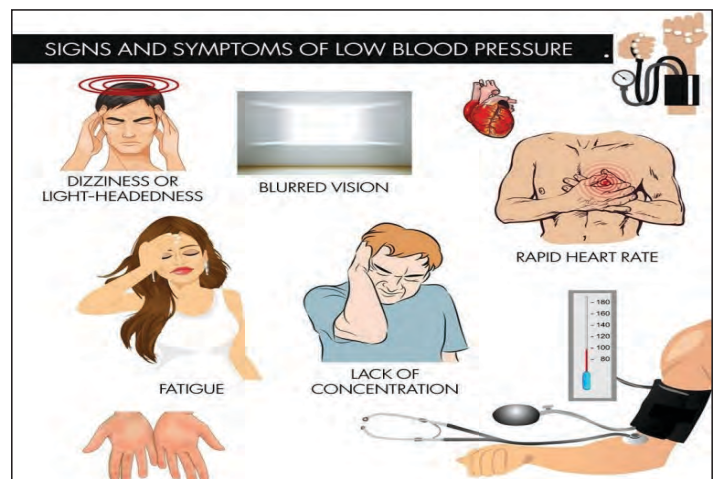



## 1. Beetroot Powder

Beetroot powder supplement has gained popularity as a natural remedy for low blood pressure. Low blood pressure, also known as hypotension, can cause symptoms like fatigue, dizziness, and fainting. Beetroot powder, derived from the root vegetable beet, is rich in nitrates that can help increase the production of nitric oxide in the body. Nitric oxide plays a crucial role in regulating blood pressure by dilating blood vessels and improving blood flow. When consumed as a supplement, beetroot powder can provide a concentrated dose of nitrates, which may help raise blood pressure to a healthier level. Additionally, beetroot powder is also packed with essential vitamins, minerals, and antioxidant polyphenols, making it a beneficial dietary addition. Beetroots are also rich in folate (vitamin B9), which is responsible for growth, development, and heart health.

These nutrients can promote overall cardiovascular health, support the immune system, and provide an energy boost. However, it is important to note that while beetroot powder has shown promising results in some studies, it should not replace medical advice or prescribed medications.

**Ingredients:** see Supplement Facts.

**Manufacturer Country:** USA

**Product Amount:** 60 caps

**DRSOUS.CA Beetroot Powder 60 Capsules Bottle**  
Regular price: \$16.00 CAD  
Product Amount: 60 caps  
Gross Weight: 0.25lb (113g)

The Beetroot vitamin supplement is created with organic and non-GMO beetroots. Beetroots contain high levels of antioxidant polyphenols, vitamins, minerals and rich in folate (vitamin B9), which is responsible for growth, development, and heart health.

- Aids in muscle recovery
- Improves cardiovascular health
- Improves blood flow
- Reduces blood pressure

Supplement Facts		
Serving Size: 2 Capsules Servings Per Container: 30		
	Amount Per Serving	% Daily Value
Organic Beetroot Powder (beta vulgaris)	1300 mg	*

\*Daily Value not established.

Inactive Ingredients: Cellulose (Vegetable Capsule), Microcrystalline Cellulose, Magnesium Stearate.

QR codes for Paradise Wellness, Dr. Sous, and www.drsous.ca.

## 2. CoQ10

CoQ10 is a naturally occurring enzyme found in every cell of the body, primarily in the mitochondria, where it plays a crucial role in energy production. It acts as an antioxidant, protecting cells from damage caused by harmful free radicals. Studies suggest that CoQ10 supplementation may help regulate blood pressure by improving cardiac function and increasing the production of ATP, the body's primary energy molecule. By enhancing cellular energy production, CoQ10 can potentially improve blood flow and help raise blood pressure to a healthier level. However, it is essential to consult a healthcare professional before adding any new supplement to your regimen, especially if you have an underlying medical condition or are taking medication that may interact with CoQ10.

**Ingredients:** see Supplement Facts.

**Manufacturer Country:** USA

**Product Amount:** 30 caps

**Gross Weight:** 0.25lb (113g)

**Suggested Use:** Take one (1) capsule twice a day as a dietary supplement. For best results, take 20-30 min before a meal or as directed by your healthcare professional.

**Caution:** Do not exceed recommended dose. Pregnant or nursing mothers, children under the age of 18, and individuals with a known medical condition should consult a physician before using this or any dietary supplement.

**Warning:** Keep out of reach of children. Do not use if the safety seal is damaged or missing. Store in a cool, dry place.

The Food and Drug Administration has not evaluated these statements. This product is not intended to diagnose, treat, cure or prevent any disease.

**DRSOUS.CA CoQ10 Ubiquinone energy production source supplement 30 Capsules**  
 Regular price: \$24.00 CAD  
 Amount: 30 caps  
 Gross Weight: 0.25lb (113g)  
 Coenzyme Q10 (CoQ10) is an antioxidant and vitamin-like compound that is found naturally in the body and in some foods like oily fish (salmon and tuna) and organ meats (liver).

Amount Per Serving	%DV
Coenzyme Q-10 (Ubiquinone) 200mg	**

\*\* Daily Value (DV) not established  
 Inactive Ingredients: Cellulose (Vegetable Capsule), Rice Flour.

www.paradisewellness.ca | Dr. Sous | www.drsous.ca

### 3. Magnesium Glycinate

Magnesium Glycinate supplement has gained popularity as a potential remedy for low blood pressure. Low blood pressure, also known as hypotension, can cause dizziness, lightheadedness, fatigue, and even fainting. Magnesium is an essential mineral that plays a crucial role in regulating blood pressure. It helps to relax and dilate blood vessels, allowing for better blood flow throughout the body. Magnesium Glycinate is a highly bioavailable and easily absorbed form of magnesium, making it an ideal choice for supplementation. This form of magnesium is bound to the amino acid glycine, which enhances its absorption and reduces the risk of digestive discomfort that can occur with other forms of magnesium supplements. By increasing magnesium levels in the body, Magnesium Glycinate may help to raise blood pressure to a healthier range. However, it is important to note that low blood pressure can have various underlying causes, and it is advisable to consult with a healthcare professional before starting any new supplement regimen.

**Magnesium Glycinate**

Magnesium Glycinate is one of the most important nutrients needed throughout the body. It is most commonly used as a natural sleep vitamin that helps calm the brain, to help the body relax and fall and stay asleep. By doing this the body is able to be rejuvenated.

www.paradisewellness.ca | A specific channel for Supplements on YouTube | www.drsous.ca

### 3) HIGH CHOLESTEROL

High cholesterol is when you have too much of a fatty substance called cholesterol in your blood. It's mainly caused by eating fatty food, not exercising enough, being overweight, smoking and drinking alcohol. It can also run in families. You can lower your cholesterol by eating healthily and getting more exercise.

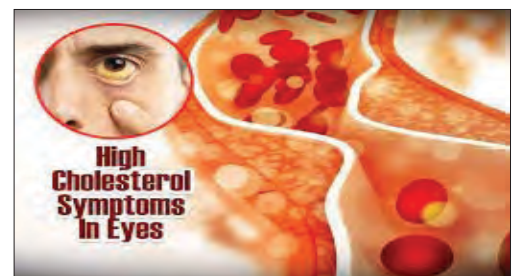

## What is high cholesterol?

High cholesterol is when you have too much of a fatty substance called cholesterol in your blood. It's mainly caused by eating fatty food, not exercising enough, being overweight, smoking and drinking alcohol. It can also run in families. You can lower your cholesterol by eating healthily and getting more exercise. Some people also need to take medicine. Too much cholesterol can block your blood vessels. It makes you more likely to have heart problems or a stroke. High cholesterol does not cause symptoms. You can only find out if you have it from a blood test.

**The recommended supplement for High Cholesterol (hyperlipidemia) are:** CoQ10, Bone & Heart Support, & Cordyceps Mushroom.

### 1. CoQ10

CoQ10, also known as Coenzyme Q10 or Ubiquinone, has gained significant attention in recent years for its potential role in managing high cholesterol, also known as hyperlipidemia. Hyperlipidemia is a condition characterized by an elevated level of lipids, such as cholesterol and triglycerides, in the bloodstream. This condition poses a significant risk to cardiovascular health, increasing the chances of developing heart disease, stroke, and other related complications. CoQ10 is a naturally occurring compound found in every cell of the body and plays a crucial role in cellular energy production. It acts as a powerful antioxidant, protecting cells from damage caused by free radicals. In the context of hyperlipidemia, CoQ10 is believed to have multiple beneficial effects. Firstly, it has been shown to reduce LDL cholesterol, commonly referred to as "bad" cholesterol. LDL cholesterol is a major contributor to the development of atherosclerosis, a condition characterized by the buildup of plaque in the arteries. By lowering LDL cholesterol, CoQ10 may help slow down or halt the progression of atherosclerosis, thus reducing the risk of cardiovascular events. Secondly, CoQ10 has been shown to increase levels of HDL cholesterol, often referred to as "good" cholesterol. HDL cholesterol helps remove excess cholesterol from the bloodstream, preventing it from depositing in the arteries. By raising HDL cholesterol levels, CoQ10 may further contribute to the overall management of hyperlipidemia. Moreover, CoQ10 has been found to possess anti-inflammatory properties, which can be beneficial in reducing the inflammation associated with hyperlipidemia and its complications. While CoQ10 is naturally produced in the body, its levels tend to decline with age, and certain medications, such as statins, commonly prescribed for managing high cholesterol, may further deplete CoQ10 levels. Therefore, supplementation with CoQ10 may be considered as an adjunct therapy to help optimize cholesterol levels and support cardiovascular health. However, it is important to note that CoQ10 should not be used as a replacement for prescribed cholesterol-lowering medications but rather as a complementary therapy under the guidance of a healthcare professional.

**Ingredients:** see Supplement Facts.

**Manufacturer Country:** USA

**Product Amount:** 30 caps

**Gross Weight:** 0.25lb (113g)

**Suggested Use:** Take one (1) capsule twice a day as a dietary supplement. For best results, take 20-30 min before a meal or as directed by your healthcare professional.

**Caution:** Do not exceed recommended dose. Pregnant or nursing mothers, children under the age of 18, and individuals with a known medical condition should consult a physician before using this or any dietary supplement.

**Warning:** Keep out of reach of children. Do not use if the safety seal is damaged or missing.

Store in a cool, dry place.

The Food and Drug Administration has not evaluated these statements. This product is not intended to diagnose, treat, cure or prevent any disease.

**DRSOUS.CA CoQ10 Ubiquinone energy production source supplement 30 Capsules**  
Regular price: \$24.00 CAD  
Amount: 30 caps  
Gross Weight: 0.25lb (113g)  
Coenzyme Q10 (CoQ10) is an antioxidant and vitamin-like compound that is found naturally in the body and in some foods like oily fish (salmon and tuna) and organ meats (liver).

**Supplement Facts**  
Serving Size: 1 Capsule  
Servings Per Container: 30

	Amount Per Serving	%DV
Coenzyme Q-10 (Ubiquinone)	200mg	**

\*\* Daily Value (DV) not established

Inactive Ingredients: Cellulose (Vegetable Capsule), Rice Flour.

www.paradisewellness.ca | Dr. Sous | www.drsous.ca

## 2. Bone & Heart Support

Bone and heart health are crucial aspects of overall well-being, especially for individuals with high cholesterol and hyperlipidemia. To address these concerns, a combination of essential nutrients such as vitamin D3, vitamin K2, and calcium can provide optimal support. Vitamin D3 plays an important role in maintaining healthy bones and teeth by aiding in the absorption of calcium from the diet. Additionally, it assists in regulating calcium levels in the blood, which is vital for proper heart function. Vitamin K2, on the other hand, aids in the activation of proteins that help direct calcium to the bones and teeth while preventing its buildup in the arteries. This is particularly important for individuals with high cholesterol or hyperlipidemia, as excess calcium in the arteries can lead to atherosclerosis and cardiovascular problems. Lastly, calcium is a mineral that is essential for maintaining strong bones and teeth. It not only supports their structure but also aids in muscle function, nerve transmission, and blood clotting. By combining these nutrients, individuals with high cholesterol and hyperlipidemia can promote bone health and reduce the risk of cardiovascular complications. It is important to consult with a healthcare professional to determine the appropriate dosage and ensure these supplements are compatible with any existing medications or medical conditions.

**Ingredients:** see Supplement Facts.

**Manufacturer Country:** USA

**Product Amount:** 60 caps

**Gross Weight:** 0.25lb (113g)

**Suggested Use:** Take one (1) capsule twice a day as a dietary supplement. For best results, take 20-30 min before a meal or as directed by your healthcare professional.

**Caution:** Do not exceed recommended dose. Pregnant or nursing mothers, children under the age of 18, and individuals with a known medical condition should consult a physician before using this or any dietary supplement.

**DrSous.Ca Bone & Heart Support**  
Regular price: \$28.00 CAD  
Product Amount: 60 caps  
Gross Weight: 0.25lb (113g)  
Bone and Heart Support is a blend of Vitamin D3 and K2 essential for regulating calcium absorption in the body for stronger and healthier bones. Both vitamins D3 and K2 are essential to the body's function and overall health.  
They both help to:  
• Increases blood flow  
• Promotes healthy bones and joints  
• Improves cardiovascular health  
• Suitable for use during pregnancy

**Supplement Facts**  
Serving Size: 1 Veggie Capsule  
Servings Per Container: 60

	Amount Per Serving	% DV
Calcium (as Calcium Citrate)	210 mg	10%
Vitamin D3 (Ergocalciferol)	125 mcg	625%
Vitamin K2 (Menaquinone-7)	100 mcg	
Solifenone (Non-Ferrous Iron Citrate)	4 mg	

† Daily Value (DV) not established.  
Other Ingredients: Cellulose (vegetable capsule).

QR codes for Paradise Wellness, Dr. Sous, and www.drsous.ca.

## 3. Cordyceps Mushroom

Cordyceps mushroom, scientifically known as *Cordyceps sinensis*, has gained significant attention in recent years as a potential natural remedy for high cholesterol, also known as hyperlipidemia. Hyperlipidemia is a condition characterized by elevated levels of cholesterol and/or triglycerides in the blood, which can increase the risk of cardiovascular diseases. Studies have suggested that Cordyceps mushroom may possess certain bioactive compounds that could help regulate lipid metabolism and reduce cholesterol levels. One of the key components found in Cordyceps is cordycepin, which has been shown to have potential cholesterol-lowering effects. This compound may inhibit the activity of key enzymes involved in cholesterol synthesis, thereby reducing the production of cholesterol in the body. Additionally, Cordyceps mushroom has been found to contain adenosine, a nucleoside that may assist in lowering blood lipid levels by inhibiting the absorption of dietary cholesterol in the intestines. Furthermore, Cordyceps mushroom has been recognized for its antioxidant properties, which can help protect against oxidative stress and inflammation, both of which are known risk factors for cardiovascular diseases.

**Ingredients:** see Supplement Facts.

**Manufacturer Country:** USA

**Product Amount:** 60 vegan capsules

**Gross Weight:** 0.2lb (90g)

**Suggested Use:** As a dietary supplement, adults take two (2) capsules daily or as directed by a healthcare professional. Can be taken with food or on an empty stomach. Store in a cool, dry place and away from direct light.

**Warning:** Keep out of reach of children. Do not use if the safety seal is damaged or missing. Store in a cool, dry place.

The Food and Drug Administration has not evaluated these statements. This product is not intended to diagnose, treat, cure or prevent any disease.

**DRSOUS.CA Cordyceps Mushroom for Energy Support**

Regular price: \$19.99 CAD  
Product Amount: 60 vegan capsules  
Gross Weight: 0.2lb (90g)

Cordyceps (cordyceps sinensis) Mushrooms are highly regarded by athletes as a natural supplement to boost endurance during training.

- Improved athletic endurance
- Anti-inflammatory
- Enhanced cardiovascular health
- Cholesterol regulation

Supplement Facts	
Serving Size: 3 Vegan Capsules	
Servings Per Container: 20	
	Amount Per 3 Daily Serving Value
Organic Cordyceps (Cordyceps sinensis)	1000mg
Mushroom Mycelium Powder (Standardized to 40% Polysaccharides (400mg))	

\*Daily value not established.  
Other ingredients: vegan capsule (potassium carbonate, water), silica.

www.paradisevet.com.ca | Dr. Sousa | www.drsous.ca

#### 4) ATHEROSCLEROSIS

Atherosclerosis is thickening or hardening of the arteries caused by a buildup of plaque in the inner lining of an artery. Risk factors may include high cholesterol and triglyceride levels, high blood pressure, smoking, diabetes, obesity, physical activity, and eating saturated fats. Atherosclerosis is thickening or hardening of the arteries caused by a buildup of plaque in the inner lining of an artery.

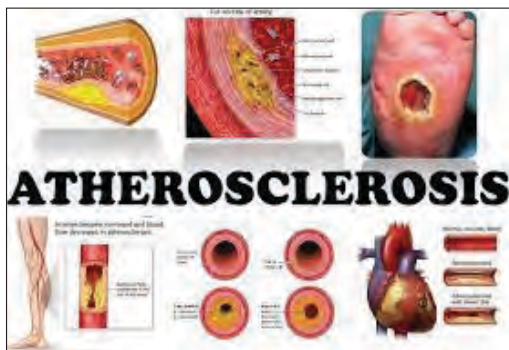

Risk factors may include high cholesterol and triglyceride levels, high blood pressure, smoking, diabetes, obesity, physical activity, and eating saturated fats. Atherosclerosis can cause a heart attack, stroke, aneurysm, or blood clot.

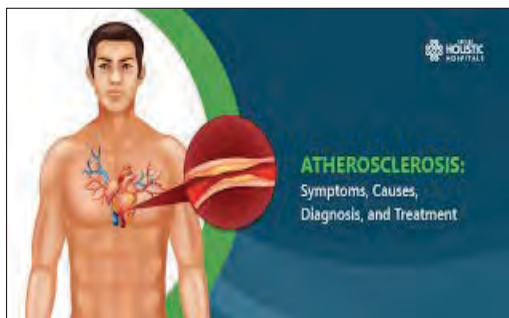

You may need medicine, treatments, or surgery to reduce the complications of atherosclerosis.

## # Symptoms

Atherosclerosis often doesn't cause symptoms until an artery is very narrow or blocked. Many people don't know they have plaque buildup until a medical emergency, like a heart attack or stroke, occurs.

You may notice symptoms if your artery is more than 70% blocked. Such extensive plaque buildup can lead to complications, which in turn cause symptoms. The chart below lists some symptoms you may feel depending on the complication

**The recommended supplements for Atherosclerosis are:** Resveratrol, Vitamin D3, & Platinum Turmeric.

### 1. Resveratrol

Resveratrol is a plant compound with potent antioxidant functionality. Resveratrol is found mainly in red wine, red grapes, berries, and peanuts. It is most concentrated in the skin of grape skins and seeds. Numerous studies have highlighted the beneficial effects of resveratrol on various aspects of cardiovascular health, particularly in relation to atherosclerosis. Resveratrol exhibits potent antioxidant and anti-inflammatory properties, which are believed to contribute to its protective effects against this chronic disease. By reducing oxidative stress and inflammation, resveratrol helps inhibit the formation of plaque and the progression of atherosclerosis. Additionally, resveratrol has been shown to enhance endothelial function, which is crucial for maintaining healthy blood vessels. It promotes the production of nitric oxide, a molecule that helps dilate blood vessels and improve blood flow. Furthermore, resveratrol has been found to modulate lipid metabolism, reducing LDL cholesterol levels and increasing HDL cholesterol, also known as the "good" cholesterol. This lipid-modulating effect may further prevent the development and progression of atherosclerosis. Moreover, resveratrol has been found to have antiplatelet and antithrombotic properties, meaning it can inhibit the formation of blood clots, which are a common complication of atherosclerosis.

**Ingredients:** see Supplement Facts.

**Manufacturer Country:** USA

**Product Amount:** 60 caps

**Gross Weight:** 0.25lb (113g)

**Suggested Use:** Take one (1) veggie capsule twice a day as a dietary supplement. For best results, take 20-30 min before a meal or as directed by your healthcare professional.

**DRSOUS.CA Resveratrol 50%  
600mg Antioxidant**  
Regular price \$28.00 CAD  
Product Amount: 60 caps  
Gross Weight: 0.25lb (113g)  
Resveratrol is an antioxidant-like compound that promotes heart health, brain health and supports weight loss.

- Cardiovascular health
- Antioxidant
- Weight control
- Anti-aging

**Supplement Facts**  
Serving Size: 1 Capsule  
Servings Per Container: 60

	Amount Per Serving	% Daily Value
Resveratrol (Polyphenol capsaicin) (100%) Complex Containing 50% Trans-Resveratrol	600mg	**

\*\* % Daily Value not established  
Other Ingredients: Vegetable Capsule (Cellulose), Microcrystalline Cellulose.

A specific channel for Resveratrol on YouTube

Paradise Wellness | Dr. Soes | www.drsoes.ca

### 2. Vitamin D3

Atherosclerosis is a chronic inflammatory disease characterized by the formation of plaque in the arteries, leading to restricted blood flow and increased risk of cardiovascular events. Recent studies have suggested that Vitamin D3 supplements may have potential benefits in the prevention and treatment of atherosclerosis. Vitamin D3, also known as cholecalciferol, is a fat-soluble vitamin that plays a

crucial role in maintaining bone health and regulating calcium metabolism. However, emerging evidence suggests that it may also have anti-inflammatory and immunomodulatory effects that can influence the development and progression of atherosclerosis. Vitamin D3 is synthesized in the skin upon exposure to sunlight, but many individuals have insufficient levels due to limited sun exposure or inadequate dietary intake. Supplementation with Vitamin D3 has been shown to increase serum levels and improve endothelial function, reduce oxidative stress, and modulate the production of pro-inflammatory cytokines involved in atherosclerosis. Moreover, Vitamin D3 may also have lipid-lowering effects, such as reducing triglyceride levels and increasing high-density lipoprotein cholesterol, which are important factors in atherosclerosis development.

**Ingredients:** see Supplement Facts.

**Manufacturer Country:** USA

**Product Amount:** 100 soft-gels

**Gross Weight:** 0.1lb (45g)

**Suggested Use:** As a dietary supplement, adults take one (1) soft-gel capsule daily or as directed by a health care professional. Store in a cool, dry place and away from direct light.



### 3. Platinum Turmeric

Curcumin, the active compound in turmeric, is believed to be responsible for many of its health benefits. Numerous studies have suggested that curcumin may help reduce inflammation, oxidative stress, and the progression of atherosclerosis. It has been shown to inhibit the activity of enzymes that promote plaque formation, as well as decrease the production of pro-inflammatory molecules that contribute to arterial wall damage. Additionally, curcumin has been found to enhance the function of endothelial cells, which line the blood vessels, thereby improving their ability to regulate blood flow and prevent clot formation. Platinum Turmeric supplements, formulated with a standardized concentration of curcumin, offer a convenient and reliable way to incorporate this powerful compound into one's daily routine. However, it's important to note that while turmeric and curcumin show promise in managing atherosclerosis, they should not be considered a substitute for medical treatment. Our Platinum Turmeric blend contains various forms of turmeric, glucosamine, Boswellia extract (frankincense), piperine, and several other highly beneficial natural extracts to keep you at your best. Natural extracts have been used for centuries in Ayurvedic medicine to remedy illnesses. We harness and advance these natural extracts in modern times for optimal bioavailability and effectiveness.

**Ingredients:** see Supplement Facts.

**Manufacturer Country:** USA

**Product Amount:** 60 caps

**Gross Weight:** 0.25lb (113g)

**Suggested Use:** Take two (2) capsules once a day as a dietary supplement. For best results, take 20-30 min before a meal or as directed by your healthcare professional.





The recommended supplement for Coronary Artery Disease are: Bone & Heart Support, CoQ10, & Magnesium glycinate.

### 1. Bone & Heart Support

The Bone & Heart Support supplement with D3, K2, and Calcium is a remarkable formulation designed to provide comprehensive support for individuals with coronary artery disease. This innovative supplement combines the power of essential nutrients, including Vitamin D3, Vitamin K2, and Calcium, to promote optimal bone and heart health. Vitamin D3 plays a crucial role in the body's absorption of calcium, which is vital for strengthening bones and teeth. Additionally, Vitamin D3 has been linked to a reduced risk of cardiovascular disease, making it an essential component of this supplement. Vitamin K2 works synergistically with Vitamin D3 by directing calcium to the bones and teeth while preventing its deposition in the arteries, reducing the risk of arterial calcification. Calcium is a fundamental mineral needed for bone strength and proper heart function. By combining these key ingredients, the Bone & Heart Support supplement aims to enhance bone density, support cardiovascular health, and minimize the progression of coronary artery disease. This powerful formulation offers individuals with coronary artery disease a natural and effective approach to managing their condition, promoting overall well-being and quality of life.

**Ingredients:** see Supplement Facts.

**Manufacturer Country:** USA

**Product Amount:** 60 caps

**Gross Weight:** 0.25lb (113g)

**Suggested Use:** Take one (1) capsule twice a day as a dietary supplement. For best results, take 20-30 min before a meal or as directed by your healthcare professional.

**Caution:** Do not exceed recommended dose. Pregnant or nursing mothers, children under the age of 18, and individuals with a known medical condition should consult a physician before using this or any dietary supplement.

**DrSous.Ca Bone & Heart Support**  
Regular price: \$28.00 CAD  
Product Amount: 60 caps  
Gross Weight: 0.25lb (113g)  
Bone and Health Support is a blend of Vitamin D3 and K2 essential for regulating calcium absorption in the body for stronger and healthier bones. Both vitamins D3 and K2 are essential to the body's function and overall health.  
They both help to:  
• Increases blood flow  
• Promotes healthy bones and joints  
• Improves cardiovascular health  
• Suitable for use during pregnancy

Supplement Facts	
Serving Size: 1 Veggie Capsule	
Servings Per Container: 60	
Amount Per Serving	%DV
Calcium (as Calcium Citrate)	210 mg 10%
Vitamin D3 (Cholecalciferol)	125 mcg 625%
Vitamin K2 (as Menaquinone-7)	100 mcg 1
Other Ingredients	3 mg 1
† Daily Value (DV) not established	

Other Ingredients: Cellulose (vegetable capsule)

QR codes for: Paradise Wellness, Dr. Sous, www.drSous.ca

109

A specific ethanol for Bone & Heart Support on YouTube

### 2. CoQ10

CoQ10 (Coenzyme Q10), also known as ubiquinone, is a naturally occurring compound in the human body that plays a crucial role in cellular energy production. It is an essential component of the electron transport chain, which is responsible for generating adenosine triphosphate (ATP), the energy currency of the body. CoQ10 has gained significant attention as a dietary supplement due to its potential benefits in managing various health conditions, including coronary artery disease (CAD).

Several studies have shown that individuals with CAD often have lower levels of CoQ10 in their blood, suggesting a potential link between CoQ10 deficiency and the development of the disease. Supplementation with CoQ10 has been found to increase the levels of this important compound in the body, thereby potentially improving heart health and reducing the risk of cardiovascular events. One of the mechanisms by which CoQ10 may benefit individuals with CAD is its antioxidant properties. Oxidative stress, caused by an imbalance between the production of harmful free radicals and the body's ability to neutralize them, is believed to play a significant role in the progression of CAD. CoQ10 acts as a potent antioxidant, scavenging free radicals and protecting cells from oxidative damage. This can

help reduce inflammation, improve endothelial function, and enhance the overall health of the cardiovascular system. Furthermore, CoQ10 has been shown to improve cardiac function in individuals with CAD. The heart requires a constant supply of energy to pump blood effectively, and CoQ10 plays a vital role in this energy production process. By supplementing with CoQ10, individuals with CAD may experience improved cardiac output, increased exercise tolerance, and reduced symptoms of angina.

**Ingredients:** see Supplement Facts.

**Manufacturer Country:** USA

**Product Amount:** 30 caps

**Gross Weight:** 0.25lb (113g)

**Suggested Use:** Take one (1) capsule twice a day as a dietary supplement. For best results, take 20-30 min before a meal or as directed by your healthcare professional.

**Caution:** Do not exceed recommended dose. Pregnant or nursing mothers, children under the age of 18, and individuals with a known medical condition should consult a physician before using this or any dietary supplement.

**Warning:** Keep out of reach of children. Do not use if the safety seal is damaged or missing. Store in a cool, dry place.

The Food and Drug Administration has not evaluated these statements. This product is not intended to diagnose, treat, cure or prevent any disease.



### 3. Magnesium Glycinate

Magnesium is an essential mineral involved in various physiological processes, including muscle contraction, nerve function, and cardiovascular health. Research suggests that magnesium deficiency may contribute to the development and progression of CAD. Magnesium Glycinate, a highly bioavailable form of magnesium, has gained attention for its potential benefits in cardiovascular health. It is believed to enhance endothelial function, reduce inflammation, and improve lipid profiles. Endothelial dysfunction, characterized by impaired dilation and constriction of blood vessels, is a key factor in the development of CAD. Magnesium Glycinate may support healthy endothelial function, leading to improved blood flow and reduced risk of CAD. Furthermore, this supplement may help decrease inflammation, a significant contributor to CAD progression. By modulating inflammatory markers, Magnesium Glycinate can potentially reduce the risk of plaque formation and arterial blockages. Additionally, studies have shown that this supplement may improve lipid profiles by increasing high-density lipoprotein (HDL) cholesterol levels and reducing low-density lipoprotein (LDL) cholesterol. Maintaining a healthy lipid profile is crucial in managing CAD. While Magnesium Glycinate shows promise in aiding CAD management, it is important to note that it should not replace other standard treatments recommended by healthcare professionals.



## 6) IRREGULAR HEARTBEATS (ARRHYTHMIAS)

A heart arrhythmia (uh-RITH-me-uh) is an irregular heartbeat. Heart rhythm problems (heart arrhythmias) occur when the electrical signals that coordinate the heart's beats don't work properly. The faulty signaling causes the heart to beat too fast (tachycardia), too slow (bradycardia) or irregularly. A heart arrhythmia (uh-RITH-me-uh) is an irregular heartbeat. Heart rhythm problems (heart arrhythmias) occur when the electrical signals that coordinate the heart's beats don't work properly. The faulty signaling causes the heart to beat too fast (tachycardia), too slow (bradycardia) or irregularly. Heart arrhythmias may feel like a fluttering or racing heart and may be harmless. However, some heart arrhythmias may cause bothersome — sometimes even life-threatening — signs and symptoms. However, sometimes it's normal for a person to have a fast or slow heart rate. For example, the heart rate may increase with exercise or slow down during sleep.

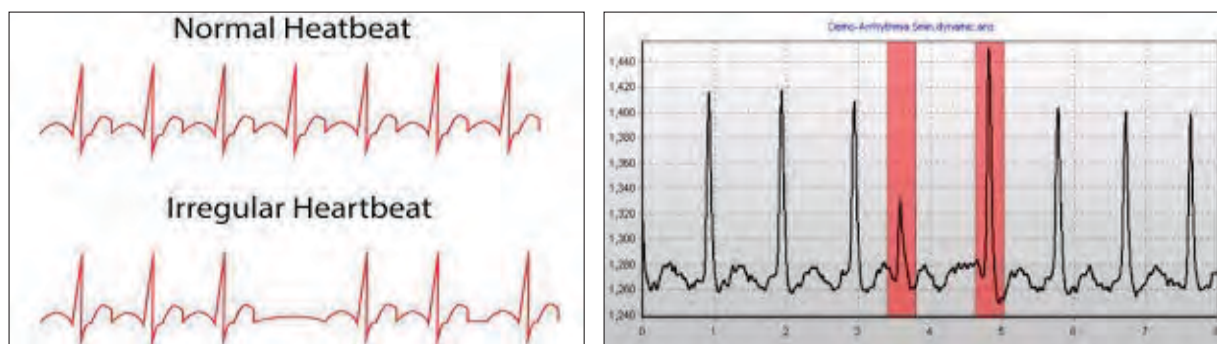

Heart arrhythmia treatment may include medications, catheter procedures, implanted devices or surgery to control or eliminate fast, slow or irregular heartbeats. A heart-healthy lifestyle can help prevent heart damage that can trigger certain heart arrhythmias.

### # Symptoms

Heart arrhythmias may not cause any signs or symptoms. A doctor may notice the irregular heartbeat when examining you for another health reason.

In general, signs and symptoms of arrhythmias may include:

- A fluttering in the chest
- A racing heartbeat (tachycardia)
- A slow heartbeat (bradycardia)
- Chest pain
- Shortness of breath

**Other symptoms may include:**

- Anxiety
- Fatigue
- Light-headedness or dizziness
- Sweating
- Fainting (syncope) or near fainting

**The recommended supplements for Irregular heartbeats (arrhythmias) are:** CoQ10, Resveratrol, & Vitamin C.

### 1. CoQ10

CoQ10 Ubiquinone is found naturally in the body. However, CoQ10 levels might decrease with age, which is why it has become a popular supplement. Research suggests that CoQ10 Ubiquinone may have a positive impact on arrhythmias by improving cellular energy production and reducing oxidative stress. It is believed to enhance the function of the mitochondria, which are often referred to as the powerhouses of our cells. By optimizing mitochondrial function, CoQ10 Ubiquinone may help stabilize the electrical signals that

regulate the heartbeat, thus reducing the occurrence of irregular rhythms. A study published in the Journal of Cardiovascular Pharmacology found that CoQ10 Ubiquinone supplementation significantly reduced the frequency and severity of ventricular arrhythmias in patients with heart failure. Another study conducted on patients with atrial fibrillation, a common type of arrhythmia, reported that CoQ10 Ubiquinone supplementation improved heart rate control and reduced the need for additional antiarrhythmic medications.

**Ingredients:** see Supplement Facts.

**Manufacturer Country:** USA

**Product Amount:** 30 caps

**Gross Weight:** 0.25lb (113g)

**Suggested Use:** Take one (1) capsule twice a day as a dietary supplement. For best results, take 20-30 min before a meal or as directed by your healthcare professional.

**Caution:** Do not exceed recommended dose. Pregnant or nursing mothers, children under the age of 18, and individuals with a known medical condition should consult a physician before using this or any dietary supplement.

**Warning:** Keep out of reach of children. Do not use if the safety seal is damaged or missing. Store in a cool, dry place.

The Food and Drug Administration has not evaluated these statements. This product is not intended to diagnose, treat, cure or prevent any disease.

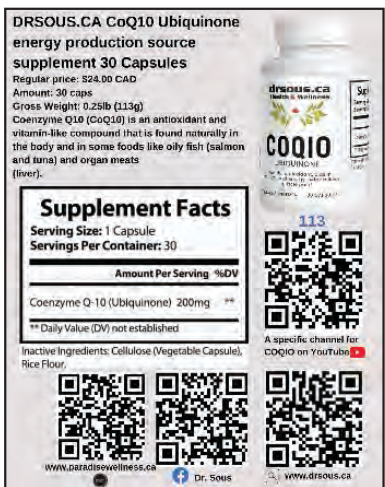

## 2. Resveratrol

Resveratrol is a plant compound with potent antioxidant functionality. Resveratrol is found mainly in red wine, red grapes, berries, and peanuts. It is most concentrated in the skin of grape skins and seeds. Arrhythmias occur when the electrical signals that regulate the heart's rhythm become disrupted, leading to an abnormal heartbeat. Resveratrol has been found to possess anti-inflammatory, antioxidant, and cardio-protective properties, which may contribute to its potential effectiveness in managing arrhythmias. Studies have suggested that resveratrol can modulate ion channels involved in regulating the heart's electrical activity, thereby helping to restore normal rhythm. Additionally, resveratrol has been shown to reduce oxidative stress and inflammation, both of which are associated with the development and progression of arrhythmias. Furthermore, resveratrol has demonstrated the ability to enhance nitric oxide production, which helps to relax blood vessels and improve blood flow, thus potentially reducing the risk of heart-related complications.

**Ingredients:** see Supplement Facts.

**Manufacturer Country:** USA

**Product Amount:** 60 caps

**Gross Weight:** 0.25lb (113g)

**Suggested Use:** Take one (1) veggie capsule twice a day as a dietary supplement. For best results, take 20-30 min before a meal or as directed by your healthcare professional.

**DRSOUS.CA Resveratrol 50% 600mg Antioxidant**  
 Regular price \$28.00 CAD  
 Product Amount: 60 caps  
 Gross Weight: 0.25lb (113g)  
 Resveratrol is an antioxidant-like compound that promotes heart health, brain health and supports weight loss.

- Cardiovascular health
- Antioxidant
- Weight control
- Anti-aging

**Supplement Facts**  
 Serving Size: 1 Capsule  
 Servings Per Container: 60

	Amount Per % Daily Serving	Value
Resveratrol (Polyphenol capsaicin) (acid) (Complex Containing 50% Trans-Resveratrol)	600mg	**

\*\* % Daily Value not established  
 Other Ingredients: Vegetable Capsule (Cellulose), Microcrystalline Cellulose

Paradise Wellness | Dr. Soles | www.drsous.ca

### 3. Vitamin D3

Vitamin D3, also known as cholecalciferol, is a crucial nutrient that plays a vital role in various physiological processes, including cardiovascular health. Research suggests that low levels of vitamin D3 may be associated with an increased risk of developing arrhythmias. Vitamin D3 has been found to have anti-inflammatory and antioxidant properties, which may help reduce inflammation and oxidative stress in the heart, thus potentially improving heart rhythm. Additionally, vitamin D3 is involved in regulating calcium homeostasis, which is essential for maintaining proper electrical conduction in the heart. Studies have shown that vitamin D3 supplementation can help improve the heart's electrical stability, decrease the occurrence of arrhythmias, and even reduce the risk of sudden cardiac death. The body naturally produces Vitamin D when exposed to sunlight, and you can also receive Vitamin D from some foods like oily fish. In the winter months, especially in colder regions, the body doesn't produce as much Vitamin D, which can lead to what's called 'seasonal depression.'

**Ingredients:** see Supplement Facts.

**Manufacturer Country:** USA

**Product Amount:** 100 soft-gels

**Gross Weight:** 0.1lb (45g)

**Suggested Use:** As a dietary supplement, adults take one (1) soft-gel capsule daily or as directed by a health care professional. Store in a cool, dry place and away from direct light.

**DRSOUS.CA Vitamin D3 helps maintain bone density, strength and healthy cell growth**

Vitamin D3 is a fat-soluble vitamin that supports the growth and development of bones and teeth. It also plays an essential role in the functioning of the muscles and boosting energy levels in the body. The body naturally produces Vitamin D when exposed to sunlight, and you can also receive Vitamin D from some foods like oily fish. In the winter months, especially in colder regions, the body doesn't produce as much Vitamin D, which can lead to what's called 'seasonal depression.'

Paradise Wellness | Dr. Soles | www.drsous.ca

### 4. Vitamin C

Arrhythmias occur when the electrical impulses that regulate the heart's rhythm become disrupted, causing the heart to beat too fast, too slow, or irregularly. This condition can be bothersome, uncomfortable, and even life-threatening in severe cases. Research has

shown that vitamin C supplementation may help in reducing the frequency and severity of arrhythmias. It is believed that vitamin C's antioxidant properties may protect the heart cells from oxidative stress, which is known to contribute to the development of arrhythmias. Additionally, vitamin C has been shown to improve the function of the endothelium, the inner lining of blood vessels, which can help regulate blood flow and reduce the risk of abnormal heart rhythms. However, it is important to note that while vitamin C supplementation may offer potential benefits for arrhythmias, it should not replace conventional medical treatments.

Our Vitamin C Gummies are a healthy, on-the-go snack for the whole family. They provide you with the daily Vitamin C that your body needs to fight off free radicals, lower blood pressure, lower the risk of heart disease and boost the immune system against infection overall.

**Ingredients:** Vitamin C (as Ascorbic Acid), Glucose Syrup, Sugar, Glucose, Apple Juice (from concentrate), Pectin, Citric Acid, Sodium Citrate, Natural Strawberry flavor, Radish Red.

**Manufacturer Country:** USA

**Product Amount:** 60 gummies

**Gross Weight:** 0.37lb (170g)

**Suggested Use:** Take two (2) capsules once a day as a dietary supplement.

**Caution:** Do not exceed recommended dose. Pregnant or nursing mothers, children under the age of 18, and individuals with a known medical condition should consult a physician before using this or any dietary supplement.

**DrSous.ca Vitamin C Gummies**  
Regular price: \$12.65 CAD  
Product Amount: 60 gummies  
Gross Weight: 0.37lb (170g)  
Vitamin C Gummies are an effective way to get the necessary daily Vitamin C for your body. They provide you with the daily Vitamin C that your body needs to fight off free radicals, lower blood pressure, lower the risk of heart disease and boost the immune system against infection overall.

	Amount Per Serving	%DV*
Calories	12	
Calories from Fat	0	
Total Carbohydrates	3g	1%
Sugar	2g	4%
Vitamin C (as Ascorbic Acid)	60mg	67%

\*The % Daily Value (DV) tells you how much a nutrient in a serving of food contributes to a daily diet. 2,000 calories a day is used for general nutrition advice.

153

A specific channel for Vitamin C on YouTube

Paradise Wellness | Dr. Sous | www.drsous.ca

## 7) CONGENITAL HEART DEFECTS

CHDs are present at birth and can affect the structure of a baby's heart and the way it works. They can affect how blood flows through the heart and out to the rest of the body. CHDs can vary from mild (such as a small hole in the heart) to severe (such as missing or poorly formed parts of the heart). Congenital heart disease is one or more problems with the heart's structure that exist since birth. Congenital means that you're born with the condition. Congenital heart disease in adults and children can change the way blood flows through the heart.

There are many different types of congenital heart defects.

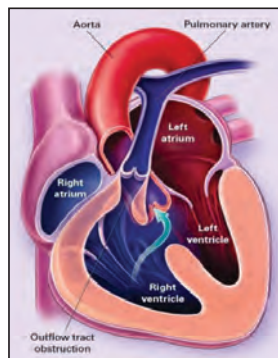

Some types of congenital heart disease may be mild. But complex defects may cause life-threatening complications. However, advances in diagnosis and treatment continue to improve survival for those with congenital heart disease.

### # Symptoms

For some people, signs or symptoms of congenital heart disease aren't noticed until adulthood. Symptoms may return years after a congenital heart defect is treated.

Common congenital heart disease symptoms in adults include:

- Irregular heart rhythms (arrhythmias)
- Blue skin, lips and fingernails (cyanosis)
- Shortness of breath
- Feeling tired very quickly with activity
- Swelling of body tissue or organs (edema)

**Irregular heartbeats (arrhythmias).** Faulty heart signaling causes the heart to beat too fast, too slowly or irregularly. In some people, severe arrhythmias may cause stroke or sudden cardiac death if not treated. Scar tissue in the heart from previous surgeries can contribute to this complication.

**Heart infection (endocarditis).** Bacteria or other germs can enter the bloodstream and move to the inner lining of the heart (endocardium). Untreated, this infection can damage or destroy the heart valves or cause a stroke. If you are at high risk of endocarditis, your care provider may recommend taking antibiotics one hour before dental cleanings. Regular dental checkups are important. Healthy gums and teeth reduce the risk that bacteria will enter the bloodstream.

**Stroke.** A congenital heart defect can allow a blood clot to pass through the heart and travel to the brain, where it reduces or blocks blood supply.

**High blood pressure in the lung arteries (pulmonary hypertension).** Some congenital heart defects send more blood to the lungs, causing pressure to build. This eventually causes the heart muscle to weaken and sometimes to fail.

Heart failure. Heart failure (congestive heart failure) means the heart can't pump enough blood to meet the body's needs.

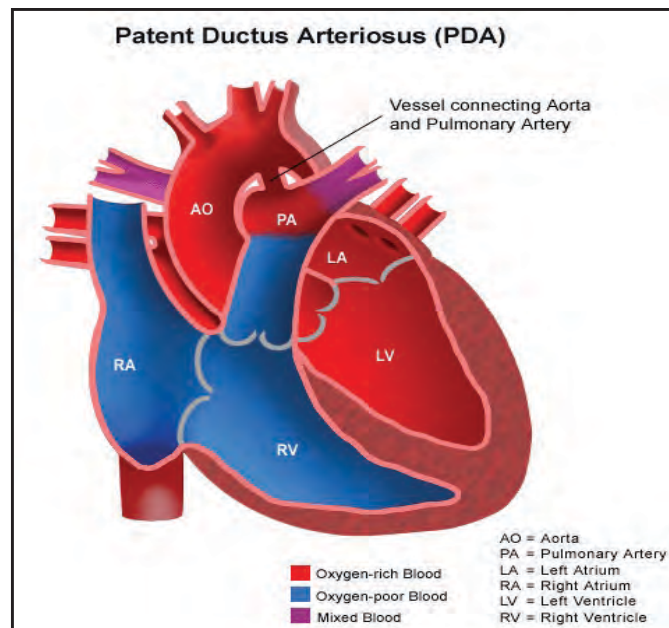

The recommended supplements for congenital heart defects are: CoQ10, Magnesium Glycinate, & Vitamin D3.

## 1. CoQ10

CoQ10 Ubiquinone has emerged as a potential therapeutic option for individuals with congenital heart defects. Congenital heart defects, which are structural abnormalities of the heart present at birth, affect millions of people worldwide. These defects can range from minor issues that require no treatment to severe conditions that may necessitate surgical intervention. CoQ10 Ubiquinone, a naturally occurring compound in the body, plays a vital role in cellular energy production and acts as an antioxidant. Research suggests that individuals with congenital heart defects may have lower levels of CoQ10 in their bodies, leading to impaired cardiac function. By supplementing with CoQ10 Ubiquinone, it is believed that these individuals may experience improvements in cardiac function and overall heart health. Studies have shown promising results, with some indicating that CoQ10 supplementation can improve exercise capacity, reduce oxidative stress, and enhance cardiac contractility in individuals with congenital heart defects.

**Ingredients:** see Supplement Facts.

**Manufacturer Country:** USA

**Product Amount:** 30 caps

**Gross Weight:** 0.25lb (113g)

**Suggested Use:** Take one (1) capsule twice a day as a dietary supplement. For best results, take 20-30 min before a meal or as directed by your healthcare professional.

**Caution:** Do not exceed recommended dose. Pregnant or nursing mothers, children under the age of 18, and individuals with a known medical condition should consult a physician before using this or any dietary supplement.

**Warning:** Keep out of reach of children. Do not use if the safety seal is damaged or missing. Store in a cool, dry place.

The Food and Drug Administration has not evaluated these statements. This product is not intended to diagnose, treat, cure or prevent any disease.

**DRSOUS.CA CoQ10 Ubiquinone**  
energy production source  
supplement 30 Capsules

Regular price: \$24.00 CAD  
Amount: 30 caps  
Gross Weight: 0.25lb (113g)  
Coenzyme Q10 (CoQ10) is an antioxidant and vitamin-like compound that is found naturally in the body and in some foods like oily fish (salmon and tuna) and organ meats (liver).

**Supplement Facts**  
Serving Size: 1 Capsule  
Servings Per Container: 30

Amount Per Serving	%DV
Coenzyme Q-10 (Ubiquinone) 200mg	**

\*\* Daily Value (DV) not established

Inactive Ingredients: Cellulose (Vegetable Capsule), Rice Flour.

A specific channel for COQ10 on YouTube

www.paradisowellness.ca | Dr. Sous | www.drsous.ca

## 2. Magnesium Glycinate

Magnesium is an essential mineral that plays a vital role in the proper functioning of the cardiovascular system. It helps regulate heart rhythm, blood pressure, and the overall health of the heart muscle. Magnesium Glycinate, specifically, is a form of magnesium that is highly bioavailable and easily absorbed by the body. This makes it an ideal choice for individuals with congenital heart defects who may have difficulty absorbing nutrients. Studies have shown that magnesium supplementation can improve heart function, reduce the risk of arrhythmias, and enhance overall cardiac health in individuals with congenital heart defects. Additionally, magnesium has been found to have a calming effect on the nervous system, alleviating stress and anxiety, which can be beneficial for individuals with heart conditions.

**Magnesium Glycinate**

Magnesium Glycinate is one of the most important nutrients needed throughout the body. It is most commonly used as a natural sleep vitamin that helps calm the brain, to help the body relax and fall and stay asleep. By doing this, the body is able to be rejuvenated.

A specific channel for Supplements on YouTube

www.paradisowellness.ca | Dr. Sous | www.drsous.ca



### 3. Vitamin D3

Vitamin D3, also known as cholecalciferol, is a fat-soluble vitamin that plays a crucial role in calcium absorption and bone health. Recent studies have suggested that Vitamin D3 may also have a role in cardiovascular health. Some evidence indicates that inadequate levels of Vitamin D3 during pregnancy could potentially contribute to the development of congenital heart defects in infants. Researchers have found that Vitamin D3 receptors are present in the fetal heart and play a role in cardiac development. Animal studies have shown that Vitamin D3 deficiency during pregnancy can lead to abnormal heart development in offspring. Moreover, epidemiological studies have found an association between low levels of Vitamin D3 in pregnant women and an increased risk of congenital heart defects in their babies. Although the exact mechanism by which Vitamin D3 affects cardiac development is not fully understood, it is believed to be related to its role in regulating gene expression and cell differentiation. Vitamin D3 also has anti-inflammatory and immunomodulatory properties, which may contribute to its potential protective effects on the developing heart.

**Ingredients:** see Supplement Facts.

**Manufacturer Country:** USA

**Product Amount:** 100 soft-gels

**Gross Weight:** 0.1lb (45g)

**Suggested Use:** As a dietary supplement, adults take one (1) soft-gel capsule daily or as directed by a health care professional. Store in a cool, dry place and away from direct light.



### 8) DEEP VEIN THROMBOSIS (DVT)

Deep vein thrombosis (DVT) occurs when a blood clot (thrombus) forms in one or more of the deep veins in the body, usually in the legs. Deep vein thrombosis can cause leg pain or swelling. Sometimes there are no noticeable symptoms.

#### Blood clot in leg vein

A blood clot in a leg vein may cause pain, warmth and tenderness in the affected area. You can get deep vein thrombosis (DVT) if you have certain medical conditions that affect how the blood clots. A blood clot in the legs can also develop if you don't move for a long time. For example, you might not move a lot when traveling a long distance or when you're on bed rest due to surgery, an illness or an accident. Deep vein thrombosis can be serious because blood clots in the veins can break loose. The clots can then travel through the bloodstream and get stuck in the lungs, blocking blood flow (pulmonary embolism). When DVT and pulmonary embolism occur together, it's called venous thromboembolism (VTE).

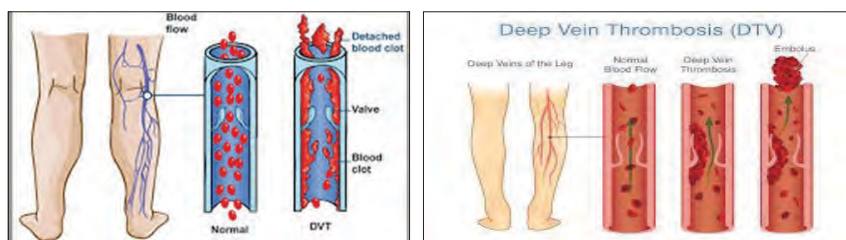



## 2. Vitamin C

Vitamin C, also known as ascorbic acid, is a powerful antioxidant that plays a crucial role in the body's immune system and collagen synthesis. It has been found to have anti-inflammatory properties and can help improve blood flow and reduce oxidative stress. These properties of Vitamin C make it a promising candidate for the prevention and treatment of DVT. Research suggests that Vitamin C can help reduce the risk of blood clot formation by promoting the health and integrity of blood vessels. It can also enhance the activity of natural anticoagulants and fibrinolytic enzymes, which are responsible for breaking down blood clots. Additionally, Vitamin C has been shown to improve endothelial function, which is essential for maintaining the health and elasticity of blood vessels. Furthermore, studies have found that Vitamin C supplementation can help reduce symptoms associated with DVT, such as pain and swelling, by reducing inflammation and improving circulation.

**Ingredients:** Vitamin C (as Ascorbic Acid), Glucose Syrup, Sugar, Glucose, Apple Juice (from concentrate), Pectin, Citric Acid, Sodium Citrate, Natural Strawberry flavor, Radish Red.

**Manufacturer Country:** USA

**Product Amount:** 60 gummies

**Gross Weight:** 0.37lb (170g)

**Suggested Use:** Take two (2) capsules once a day as a dietary supplement.

**Caution:** Do not exceed recommended dose. Pregnant or nursing mothers, children under the age of 18, and individuals with a known medical condition should consult a physician before using this or any dietary supplement.

**DrSous.Ca Vitamin C Gummies**  
Regular price: \$12.65 CAD  
Product Amount: 60 gummies  
Gross Weight: 0.37lb (170g)  
Vitamin C Gummies are an effective way to get the necessary daily Vitamin C for your body. They provide you with the daily Vitamin C that your body needs to fight off free radicals, lower blood pressure, lower the risk of heart disease and boost the immune system against infection overall.

	Amount Per Serving	%DV*
Calories	12	
Calories from Fat	0	
Total Carbohydrates	5g	1%
Sugar	5g	4%
Vitamin C (as Ascorbic Acid)	60mg	67%

\*The % Daily Value (%DV) lets you know how much a nutrient in a serving of food contributes to a daily diet. 2,000 calories a day is used for general nutrition advice.

153

A specific channel for Vitamin C on YouTube

Paradise Press Dr. Sous www.drsous.ca

## 3. Ginkgo Biloba + Ginseng

Ginkgo Biloba is derived from the leaves of the Ginkgo tree and has been used in traditional medicine for centuries. It is believed to have anti-inflammatory and antioxidant properties, which may help reduce the risk of blood clot formation. Additionally, Ginkgo Biloba is thought to improve blood circulation by dilating blood vessels and inhibiting platelet aggregation.

Ginseng is believed to have antiplatelet and anticoagulant properties, which could potentially be beneficial in preventing blood clot formation. Additionally, Ginseng is thought to have anti-inflammatory effects and may improve circulation, which could be helpful in managing DVT.

It is important to note that herbal supplements like Ginkgo Biloba and Ginseng should not be used as a substitute for medical treatment or prescribed medications for DVT. If you suspect you have DVT or have been diagnosed with it, it is crucial to consult with a healthcare professional for proper evaluation and guidance.

**Ingredients:** See Supplement Facts.

**Manufacturer Country:** USA

**Product Amount:** 60 caps

**Gross Weight:** 0.25lb (133g)

**Suggested Use:** As a dietary supplement, take two (2) capsules before bedtime or as directed by your healthcare professional.  
**Warning:** Keep out of reach of children. Do not use if the safety seal is damaged or missing. Store in a cool, dry place.  
 The Food and Drug Administration has not evaluated these statements. This product is not intended to diagnose, treat, cure or prevent any disease.

**DrSous.ca Ginkgo Biloba + Ginseng**  
 Regular price: \$29.00 CAD  
 Product Amount: 60 caps  
 Gross Weight: 0.25lb (113g)  
 Ginkgo Biloba is a herb used in ancient Chinese medicine for its effective antioxidant properties. Ginkgo Biloba is one of the oldest and most-commonly-used brain supplement for better mental function. Combine it with Ginseng for benefits to blood flow, oxygen, nutrient absorption in the brain & to strengthen the immune system.

- Anti-aging
- Helps to combat cold and flu symptoms.
- Improved memory and cognition
- Strong antioxidant

**Supplement Facts**  
 Serving Size: 2 Capsules  
 Servings Per Container: 30

	Amount Per Serving	%DV
Red Flower Ginseng Extract (Standardized to 7% Ginsenosides)	300mg	**
Ginkgo Biloba Leaf Powder	500mg	**
Ginkgo Biloba Leaf 24% Flavones	70mg	**

\*\* Daily Value (DV) not established  
 Other Ingredients: Vegetable Cellulose, Hypromellose, Silicon Dioxide

QR codes for Paradise Wellness, Dr. Sous, and www.drsous.ca. A specific channel for Ginkgo Biloba on YouTube is also mentioned.

#### 4. CoQ10

CoQ10 is a naturally occurring enzyme found in every cell of the body, responsible for producing energy and protecting cells from damage caused by free radicals. Research suggests that CoQ10 may play a role in reducing the risk of blood clot formation and improving overall vascular health. It is believed to act as an antioxidant, preventing oxidative stress and inflammation, which are known contributors to blood clot formation. Furthermore, CoQ10 may enhance the production of nitric oxide, a molecule that helps relax blood vessels and improve blood flow. These potential mechanisms of action make CoQ10 an intriguing option for individuals at risk of or suffering from DVT.

**Ingredients:** see Supplement Facts.

**Manufacturer Country:** USA

**Product Amount:** 30 caps

**Gross Weight:** 0.25lb (113g)

**Suggested Use:** Take one (1) capsule twice a day as a dietary supplement. For best results, take 20-30 min before a meal or as directed by your healthcare professional.

**Caution:** Do not exceed recommended dose. Pregnant or nursing mothers, children under the age of 18, and individuals with a known medical condition should consult a physician before using this or any dietary supplement.

**Warning:** Keep out of reach of children. Do not use if the safety seal is damaged or missing. Store in a cool, dry place.

The Food and Drug Administration has not evaluated these statements. This product is not intended to diagnose, treat, cure or prevent any disease.

**DRSOUS.CA CoQ10 Ubiquinone energy production source supplement 30 Capsules**  
 Regular price: \$24.00 CAD  
 Amount: 30 caps  
 Gross Weight: 0.25lb (113g)  
 Coenzyme Q10 (CoQ10) is an antioxidant and vitamin-like compound that is found naturally in the body and in some foods like oily fish (salmon and tuna) and organ meats (liver).

**Supplement Facts**  
 Serving Size: 1 Capsule  
 Servings Per Container: 30

	Amount Per Serving	%DV
Coenzyme Q-10 (Ubiquinone)	200mg	**

\*\* Daily Value (DV) not established  
 Inactive Ingredients: Cellulose (Vegetable Capsule), Rice Flour

QR codes for Paradise Wellness, Dr. Sous, and www.drsous.ca. A specific channel for COQ10 on YouTube is also mentioned.

## 9) ANEMIA

Anemia is a condition in which the body does not have enough healthy red blood cells. Red blood cells provide oxygen to body tissues. Different types of anemia include: Anemia due to vitamin B12 deficiency. Anemia due to folate (folic acid) deficiency.

Anemia happens when you don't have enough red blood cells or your red blood cells don't work as they should. Your red blood cells carry oxygen throughout your body. Oxygen powers your cells and gives you energy. Without healthy red blood cells that do their job, your body doesn't get the energy it needs to function. While some types of anemia are short-term and mild, others can last for a lifetime. Left untreated, anemia may be life-threatening.

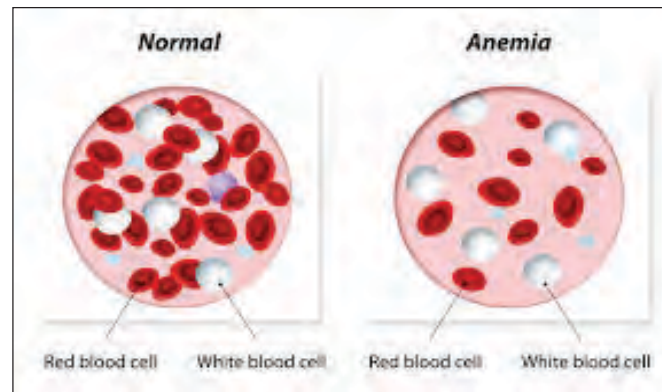

**Hemolytic anemia:** In this anemia, your red blood cells break down or die faster than usual.

**Aplastic anemia:** This anemia happens when stem cells in your bone marrow don't make enough red blood cells.

**Autoimmune hemolytic anemia:** In autoimmune hemolytic anemia, your immune system attacks your red blood cells.

**Sideroblastic anemia:** In sideroblastic anemia, you don't have enough red blood cells and you have too much iron in your system.

**Macrocytic anemia:** This anemia happens when your bone marrow makes unusually large red blood cells.

**Microcytic anemia:** This anemia happens when your red blood cells don't have enough hemoglobin so they're smaller than usual.

**Normocytic anemia:** In this type of anemia, you have fewer red blood cells than usual, and those red blood cells don't have the normal amount of hemoglobin.

### # Symptoms

- Fatigue — feeling too tired to manage your activities — is the most noticeable anemia symptom. Other symptoms may include:
- Shortness of breath (dyspnea): This is the feeling you can't catch your breath or take a deep breath.
- Dizziness: This is feeling lightheaded or unsteady on your feet.
- Fast or irregular heartbeat (arrhythmia): This is when your heart feels like it's racing or skipping beats.
- Pounding or "whooshing" sound in your ear (pulsatile tinnitus): This is a swooshing sound in one of your ears that may come and go.
- Headache: Iron-deficiency anemia and anemias caused by low hemoglobin may cause headaches.
- Pale or yellow skin: Your skin color may be paler than usual.
- Chest pain: This may feel like something is pressing on or squeezing your chest.

**The recommended supplements for Anemia:** B-12 Drop, Spirulina, Elderberry & Vitamin C

### 1. B-12 Drops

B12 complex for anaemia is a crucial treatment option that plays a vital role in managing and alleviating the symptoms of this common blood disorder. Anaemia, characterized by a low red blood cell count or insufficient hemoglobin levels, can lead to fatigue, weakness, shortness of breath, and various other health complications. B12 complex, which consists of vitamin B12 and other B vitamins, is particularly effective in treating anaemia caused by a deficiency of vitamin B12. Vitamin B12 is essential for the production of healthy red blood cells and the proper functioning of the nervous system. By supplementing the body with B12 complex, individuals with anaemia can restore their vitamin B12 levels, leading to an improvement in the symptoms associated with the condition. Additionally,

B12 complex aids in the absorption of iron, another crucial nutrient for red blood cell production. This synergy between B12 and iron makes B12 complex an even more effective treatment for anaemia.



## 2. Spirulina

Spirulina, a blue-green algae, has gained significant attention for its potential benefits in managing anaemia. Anaemia, a condition characterized by a deficiency of red blood cells or hemoglobin, can lead to fatigue, weakness, and impaired cognitive function. Spirulina is a rich source of iron, an essential mineral involved in the production of hemoglobin. It contains a highly bioavailable form of iron, making it easier for the body to absorb and utilize. Consuming spirulina can help replenish iron stores and increase hemoglobin levels in individuals with anaemia. Additionally, spirulina is packed with other nutrients like vitamin B12 and folic acid, which are crucial for red blood cell production. These nutrients work synergistically with iron to promote healthy blood cells and improve oxygen transportation throughout the body. Moreover, spirulina has been found to possess antioxidant properties, which can reduce oxidative stress and inflammation commonly associated with anaemia. By combating oxidative damage, spirulina may help protect and preserve red blood cells, further contributing to the management of anaemia.



**Ingredients:** see Supplement Facts.

**Manufacturer Country:** USA

**Product Amount:** 0.26lb (120g)

**Gross Weight:** 0.27lb (125g)

**Suggested Use:** The recommended starting dosage is ½ teaspoon a day, gradually increasing to 3 teaspoons, taken with food or around an hour before mealtimes.

**Warning:** Keep out of reach of children. Do not use if the safety seal is damaged or missing. Store in a cool, dry place.

### 3. Elderberry & Vitamin C

Elderberry, derived from the European elder tree, is rich in antioxidants, vitamins, and minerals that can support overall health and well-being. It contains high levels of vitamin C, which plays a crucial role in the absorption of iron, a key nutrient for red blood cell production. By increasing iron absorption, elderberry can potentially help combat anaemia by boosting the production of red blood cells and improving oxygen transport throughout the body. Additionally, elderberry's antioxidant properties can help reduce oxidative stress and inflammation, which are often associated with anaemia. Vitamin C, on the other hand, is known for its immune-boosting properties and its ability to enhance iron absorption. In the context of anaemia, vitamin C can aid in the absorption of iron from plant-based sources, such as leafy greens and legumes, which are especially important for individuals following vegetarian or vegan diets. Furthermore, vitamin C supports the body's production of collagen, a protein necessary for the formation and maintenance of blood vessels, which can help prevent and address certain types of anaemia.

This gummy is also popular way to obtain immune-boosting minerals, such as Vitamin C, Zinc, and Elderberry and create resistance against viral attacks on our bodies that frequently occur during peak cold and flu season.

With these Elderberry and Vitamin C gummies, there is no need to worry about taking capsules or dealing with undesirable side effects such as digestive discomfort.

**Ingredients:** see Supplement Facts.

**Flavor:** Elderberry

**Manufacturer Country:** USA

**Product Amount:** 60 gummies

**Gross Weight:** 0.56lb (255g)

**Suggested Use:** Take two (2) gummies once a day as a dietary supplement.

**Caution:** Do not exceed recommended dose. Pregnant or nursing women, children under 18, and individuals with known medical conditions should consult their physician before taking.

**DRSOUS.CA Elderberry & Vitamin C Gummies**

Regular price: \$25.00 CAD  
Product Amount: 60 gummies  
Gross Weight: 0.56lb (255g)

Packed with immune-boosting nutrients, including Vitamin C, Zinc, and Elderberry, this gummy is a popular way to receive antioxidants and boost overall health.

- Immune boosting
- Overall health
- Eases cold and flu symptoms
- Improves iron absorption

**Supplement Facts**

	Amount Per Serving	% Daily Value
<b>Total Gummies</b>	60	100%
<b>Vitamin C (Ascorbic Acid)</b>	1000 mg	2000%
<b>Zinc (Zinc Oxide)</b>	15 mg	300%
<b>Elderberry (Sambucus nigra)</b>	100 mg	100%
<b>Other Ingredients:</b> Gelatin, Sugar, Stevia, Natural Flavors, and Other Natural Ingredients.		

©2020 Paradise Wellness. All rights reserved.  
Other ingredients: Gelatin, Sugar, Stevia, Natural Flavors, and Other Natural Ingredients.  
Paradise Wellness is a registered trademark of Paradise Wellness.

Dr. Soles | www.drsoles.ca

### 10) BLOOD CLOTS

Blood clotting, or coagulation, is an important process that prevents excessive bleeding when a blood vessel is injured. Platelets (a type of blood cell) and proteins in your plasma (the liquid part of blood) work together to stop the bleeding by forming a clot over the injury. A blood clot is a semi-solid mass of blood cells and other substances that form in your blood vessels. Blood clots protect you from bleeding too much if you're injured or have surgery. However, you may develop blood clots for other reasons, such as having certain medical conditions. When that happens, blood clots may cause symptoms and can be life-threatening.

#### What do blood clots do?

Blood clots are the first line of defense if something damages your delicate blood vessels. If you cut yourself from shaving, blood clots are why the bleeding usually stops after a few seconds or minutes.

You can develop a blood clot for other reasons, such as being immobile for a long time or having medical conditions that increase your blood clot risk. When that happens, your blood doesn't flow as it should.

### What do blood clots look like?

A blood clot may look like a clump of reddish jelly held in place with netting. A closer look at a blood clot may show cells that look like tiny plates. These are platelets. The netting is fibrin. Blood clots' red color comes from red blood cells that are trapped in fibrin as they flow past the injured area.

### # Symptoms

What are the 10 signs of blood clotting?

Warning Signs and Symptoms of Blood Clots

- Swelling in the leg or arm.
- Tenderness or cramps in the leg.
- Out of breath, or shortness of breath.
- Passing out or feeling lightheaded.
- Chest pain or back pain when breathing.
- Leg discoloration, either a red or blue hue.
- Overdrive, when your heart is racing.

**The recommended supplements for Blood Clots are:** Platinum Turmeric, Ginkgo Biloba + Ginseng, Vitamin D3)

### 1. Platinum Turmeric

Turmeric contains a compound called curcumin, which has been studied for its anti-inflammatory and antioxidant properties. These properties may play a role in preventing blood clots by reducing inflammation and oxidative stress, both of which are implicated in the formation of clots. Our Platinum Turmeric blend contains various forms of turmeric, glucosamine, Boswellia extract (frankincense), piperine, ginger extract and several other highly beneficial natural extracts to keep you at your best.

Ginger, a root commonly used in culinary and traditional medicine, contains bioactive compounds such as gingerols and shogaols that possess anti-inflammatory and anticoagulant properties. These compounds have been shown to inhibit platelet aggregation and reduce the risk of blood clot formation. Ginger also promotes blood circulation, which can help prevent the formation of stagnant blood pools that may contribute to clot formation. Similarly, pepper, particularly black pepper, contains a compound called piperine that has been found to possess antiplatelet activity, inhibiting the clumping of blood cells. Additionally, black pepper exhibits antioxidant and anti-inflammatory effects, further contributing to its potential role in preventing blood clot formation.

Natural extracts have been used for centuries in Ayurvedic medicine to remedy illnesses. We harness and advance these natural extracts in modern times for optimal bioavailability and effectiveness.

**Ingredients:** see Supplement Facts.

**Manufacturer Country:** USA

**Product Amount:** 60 caps

**Gross Weight:** 0.25lb (113g)

**Suggested Use:** Take two (2) capsules once a day as a dietary supplement. For best results, take 20-30 min before a meal or as directed by your healthcare professional.

**DrSous.Ca Platinum Turmeric 60**  
**Capsule Bottle**  
Regular price: \$20.00 CAD  
Product Amount: 60 caps  
Gross Weight: 0.25lb (113g)

Our Platinum Turmeric blend contains various forms of turmeric, glucosamine, Boswellia extract (frankincense), piperine, and several other highly beneficial natural extracts to keep you at your best.

- Anti-inflammatory
- Joint and bone health
- Heart Protective
- Anti-oxidant & Anti- Cancer

**Supplement Facts**

Amount Per Serving (100%)	
Total Turmeric	1000mg
Curcumin	500mg
Black Pepper	500mg
Glucosamine	500mg
Boswellia	500mg
Ginger	500mg
Piperine	500mg
Other Ingredients	500mg

Other Ingredients: Cellulose, Hydroxypropyl Methylcellulose, Povidone, Croscarmellose, Magnesium Stearate, Stearic Acid, and Titanium Dioxide.

Dr. Sous  
www.drsous.ca



## 2. Ginkgo Biloba + Ginseng

Ginkgo Biloba and Ginseng are two herbal supplements that have been studied for their potential benefits in preventing or treating blood clots. Ginkgo Biloba is derived from the leaves of the Ginkgo tree and has been used in traditional medicine for centuries. It contains compounds called flavonoids and terpenoids, which have antioxidant and anti-inflammatory properties. These properties may help reduce the risk of blood clot formation by improving blood flow and preventing platelet aggregation. Ginseng, on the other hand, is a plant root that is commonly used in traditional Chinese medicine. It contains active compounds called ginsenosides, which have been shown to have antiplatelet and anticoagulant effects. These effects can help prevent the formation of blood clots and reduce the risk of clot-related conditions such as deep vein thrombosis or stroke.

**Ingredients:** See Supplement Facts.

**Manufacturer Country:** USA

**Product Amount:** 60 caps

**Gross Weight:** 0.25lb (133g)

**Suggested Use:** As a dietary supplement, take two (2) capsules before bedtime or as directed by your healthcare professional.

**Warning:** Keep out of reach of children. Do not use if the safety seal is damaged or missing. Store in a cool, dry place.

The Food and Drug Administration has not evaluated these statements. This product is not intended to diagnose, treat, cure or prevent any disease.

**DrSous.Ca Ginkgo Biloba + Ginseng**  
Regular price: \$29.00 CAD  
Product Amount: 60 caps  
Gross Weight: 0.25lb (133g)  
Ginkgo Biloba is a herb used in ancient Chinese medicine for its effective antioxidant properties. Ginkgo Biloba is one of the oldest and most-commonly-used brain supplement for better mental function. Combine it with Ginseng for benefits to blood flow, oxygen, nutrient absorption in the brain & to strengthen the immune system.

- \* Anti-aging
- \* Helps to combat cold and flu symptoms.
- \* Improved memory and cognition
- \* Strong antioxidant

Supplement Facts			
Serving Size: 2 Capsules			
Servings Per Container: 30			
	Amount Per Serving	% DV	
Red Panax Ginseng Extract (Standardized to 70% Ginsenosides/sterols)	500mg	**	
Ginkgo Biloba Leaf Powder	500mg	50	
Ginkgo Biloba Leaf 20% Flavones	500mg	50	
** Daily Value (DV) not established			

Other Ingredients: Vegetable Cellulose, Vegetable Starch, Silicon Dioxide

QR codes for Paradise Wellness, Dr. Sous, and www.drsous.ca

A specific channel for Ginkgo Biloba on YouTube

## 3. Vitamin D3

Vitamin D3, also known as the “sunshine vitamin,” has been gaining attention in recent years for its potential role in preventing blood clots. Blood clots, also known as thrombosis, occur when blood thickens and forms a semisolid mass. While blood clotting is a normal and essential process to prevent excessive bleeding, it can become problematic when clots form inappropriately or in excessive amounts. Research suggests that vitamin D3 may play a crucial role in regulating blood clot formation and preventing the development of harmful clots. Studies have shown that individuals with lower levels of vitamin D3 in their blood are more susceptible to blood clot formation. Vitamin D3 is thought to exert its anticoagulant effects by inhibiting the production of certain clotting factors and promoting the production of natural anticoagulant proteins. Furthermore, vitamin D3 has been shown to have anti-inflammatory effects, which may also contribute to its ability to prevent blood clots.

**Ingredients:** see Supplement Facts.

**Manufacturer Country:** USA

**Product Amount:** 100 soft-gels

**Gross Weight:** 0.1lb (45g)

**Suggested Use:** As a dietary supplement, adults take one (1) soft-gel capsule daily or as directed by a health care professional. Store in a cool, dry place and away from direct light.

**DRSOUS.CA Vitamin D3 helps maintain bone density, strength and healthy cell growth**

Vitamin D3 is a fat-soluble vitamin that supports the growth and development of bones and teeth. It also plays an essential role in the functioning of the muscles and boosting energy levels in the body. The body naturally produces Vitamin D when exposed to sunlight, and you can also receive Vitamin D from some foods like oily fish. In the winter months, especially in colder regions, the body doesn't produce as much Vitamin D, which can lead to what's called 'seasonal depression.'



www.paradiseofwellness.ca

A specific channel for Supplements on YouTube

Dr. Sous | www.drsous.ca

## 11) HEMOPHILIA

Hemophilia is a rare disorder in which the blood doesn't clot in the typical way because it doesn't have enough blood-clotting proteins (clotting factors). If you have hemophilia, you might bleed for a longer time after an injury than you would if your blood clotted properly.

Hemophilia is usually an inherited bleeding disorder in which the blood does not clot properly. This can lead to spontaneous bleeding as well as bleeding following injuries or surgery. Blood contains many proteins called clotting factors that can help to stop bleeding. People with hemophilia have low levels of either factor VIII (8) or factor IX (9). The severity of hemophilia that a person has is determined by the amount of factor in the blood. The lower the amount of the factor, the more likely it is that bleeding will occur which can lead to serious health problems.

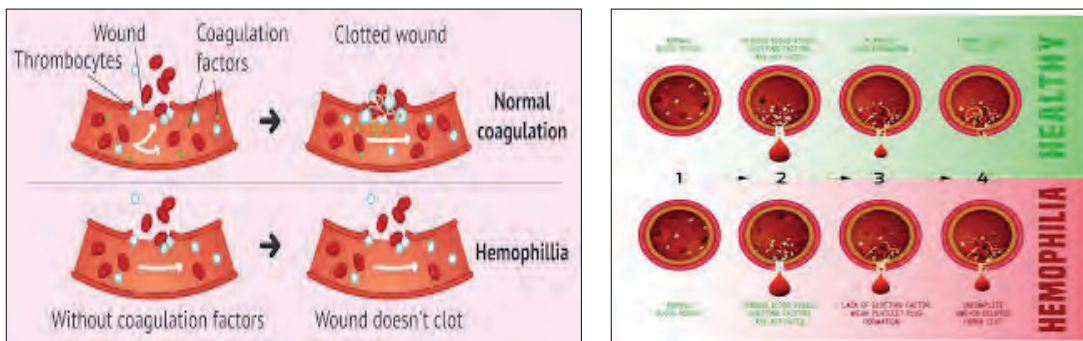

### Types

There are several different types of hemophilia. The following two are the most common:

**Hemophilia A (Classic Hemophilia):** This type is caused by a lack or decrease of clotting factor VIII.

**Hemophilia B (Christmas disease):** This type is caused by a lack or decrease of clotting factor IX.

### # Symptoms

Common signs of hemophilia include:

- Bleeding into the joints. This can cause swelling and pain or tightness in the joints; it often affects the knees, elbows, and ankles.
- Bleeding into the skin (which is bruising) or muscle and soft tissue causing a build-up of blood in the area (called a hematoma).
- Bleeding of the mouth and gums, and bleeding that is hard to stop after losing a tooth.
- Bleeding after circumcision (surgery performed on male babies to remove the hood of skin, called the foreskin, covering the head of the penis).
- Bleeding after having shots, such as vaccinations.
- Bleeding in the head of an infant after a difficult delivery.

- Blood in the urine or stool.
- Frequent and hard-to-stop nosebleeds.

**The recommended supplements for Hemophilia are:** Bone & Heart Support, CoQ10, Elderberry & Vitamin C

### 1. Bone & Heart Support

Our bone and heart support is a good blend of Vitamin K and D3. Hemophilia is a genetic disorder characterized by a deficiency in clotting factors, which can lead to excessive bleeding and bruising. While there is no cure for hemophilia, there are various treatments and management strategies available to help individuals with this condition lead healthier lives. When it comes to managing hemophilia, supplements can play a crucial role in supporting overall health and minimizing the risk of bleeding episodes. One of the best supplements for hemophilia is vitamin K. Vitamin K is essential for blood clotting as it helps activate clotting factors in the liver. By supplementing with vitamin K, individuals with hemophilia can ensure that their bodies have an adequate supply of this vital nutrient for proper clot formation. Vitamin D3 may play a role in hemophilia management. One potential benefit is its ability to enhance bone health, as individuals with hemophilia are at an increased risk of developing osteoporosis and joint damage due to recurrent bleeding episodes. Vitamin D3 helps in the absorption of calcium, promoting bone mineralization and reducing the risk of fractures. Additionally, it has been hypothesized that vitamin D3 may have anti-inflammatory properties, which could potentially alleviate joint pain and swelling associated with hemophilia.

**Ingredients:** see Supplement Facts.

**Manufacturer Country:** USA

**Product Amount:** 60 caps

**Gross Weight:** 0.25lb (113g)

**Suggested Use:** Take one (1) capsule twice a day as a dietary supplement. For best results, take 20-30 min before a meal or as directed by your healthcare professional.

**Caution:** Do not exceed recommended dose. Pregnant or nursing mothers, children under the age of 18, and individuals with a known medical condition should consult a physician before using this or any dietary supplement.

**Warning:** Keep out of reach of children. Do not use if the safety seal is damaged or missing. Store in a cool, dry place.

The Food and Drug Administration has not evaluated these statements. This product is not intended to diagnose, treat, cure or prevent any disease.

### 2. CoQ10

CoQ10 Ubiquinone is found naturally in the body. However, CoQ10 levels might decrease with age, which is why it has become a popular supplement. Ubiquinone may have potential therapeutic effects in managing hemophilia, a genetic bleeding disorder. Hemophilia is characterized by a deficiency or dysfunction of specific clotting factors, leading to prolonged bleeding and difficulty in clot formation. Although current treatment options for hemophilia focus on replacing the missing clotting factor, researchers are exploring alternative approaches to enhance clotting and reduce bleeding episodes. CoQ10 Ubiquinone has been found to possess antioxidant and anti-inflammatory properties, which could potentially contribute to hemostasis and reduce bleeding in individuals with hemophilia. Additionally, some studies have indicated that CoQ10 Ubiquinone may improve endothelial function and blood flow, which could be beneficial for individuals with hemophilia who often experience impaired blood circulation.

Ubiquinone also contributes to energy production. CoQ10 safeguards cells against oxidative damage. It is also essential for producing ATP, the body's major energy source.

**Ingredients:** see Supplement Facts.

**Manufacturer Country:** USA

**Product Amount:** 30 caps

**Gross Weight:** 0.25lb (113g)

**Suggested Use:** Take one (1) capsule twice a day as a dietary supplement. For best results, take 20-30 min before a meal or as directed

by your healthcare professional.

**Caution:** Do not exceed recommended dose. Pregnant or nursing mothers, children under the age of 18, and individuals with a known medical condition should consult a physician before using this or any dietary supplement.

**Warning:** Keep out of reach of children. Do not use if the safety seal is damaged or missing. Store in a cool, dry place.

The Food and Drug Administration has not evaluated these statements. This product is not intended to diagnose, treat, cure or prevent any disease.

**DRSOUS.CA CoQ10 Ubiquinone**  
energy production source  
**supplement 30 Capsules**  
Regular price: \$24.00 CAD  
Amount: 30 caps  
Gross Weight: 0.25lb (113g)  
Coenzyme Q10 (CoQ10) is an antioxidant and vitamin-like compound that is found naturally in the body and in some foods like oily fish (salmon and tuna) and organ meats (liver).

**Supplement Facts**  
Serving Size: 1 Capsule  
Servings Per Container: 30

Amount Per Serving	%DV
Coenzyme Q-10 (Ubiquinone) 200mg	**

\*\* Daily Value (DV) not established

Inactive Ingredients: Cellulose (Vegetable Capsule), Rice Flour.

www.paradisowellness.ca | Dr. Sous | www.drsous.ca

### 3. Elderberry & Vitamin C Gummies

Vitamin C is an essential nutrient that plays a crucial role in wound healing and collagen production, which are important for maintaining healthy blood vessels. By incorporating Vitamin C into the diet, individuals with hemophilia may experience improved wound healing and reduced bleeding episodes. Additionally, elderberry is known for its immune-boosting properties, as it is rich in antioxidants and vitamins. Strengthening the immune system can be particularly important for individuals with hemophilia, as they may be more susceptible to infections due to their condition. The combination of elderberry and Vitamin C in gummy form provides a convenient and enjoyable way to supplement the diet with these beneficial nutrients. These gummies are not only tasty but also provide a practical solution for individuals who may have difficulty swallowing pills or prefer a more enjoyable method of supplementation. Overall, Elderberry & Vitamin C Gummies can be a valuable addition to the management of hemophilia, helping to support overall health and well-being for individuals with this condition.

**Ingredients:** see Supplement Facts.

**Flavor:** Elderberry

**Manufacturer Country:** USA

**Product Amount:** 60 gummies

**Gross Weight:** 0.56lb (255g)

**Suggested Use:** Take two (2) gummies once a day as a dietary supplement.

**Caution:** Do not exceed recommended dose. Pregnant or nursing women, children under 18, and individuals with known medical conditions should consult their physician before taking.

**Warning:** Keep out of reach of children. Do not use if the safety seal is damaged or missing. Store in a cool, dry place.

**DRSOUS.CA Elderberry & Vitamin C Gummies**

Regular price: \$25.00 CAD  
Product Amount: 60 gummies  
Gross Weight: 0.56lb (255g)  
Packed with immune-boosting nutrients, including Vitamin C, Zinc, and Elderberry, this gummy is a popular way to receive antioxidants and boost overall health.

- Immune boosting
- Overall health
- Eases cold and flu symptoms
- Improves iron absorption

**Supplement Facts**  
Serving Size: 1 Gummy  
Servings Per Container: 60

Amount Per Serving	% Daily Value
Vitamin C (Ascorbic Acid)	20%
Zinc (Zinc Oxide)	10%
Elderberry (Elderberry Extract)	10%
Other Ingredients: Sugar, Gelatin, Citric Acid, Natural Flavors, Stevia Leaf Extract, Vitamin E, Vitamin D3, Vitamin K1, Vitamin B12, Vitamin B6, Vitamin B9, Vitamin B5, Vitamin B3, Vitamin B1, Vitamin A, Vitamin K2, Vitamin D2, Vitamin D4, Vitamin D5, Vitamin D6, Vitamin D7, Vitamin D8, Vitamin D9, Vitamin D10, Vitamin D11, Vitamin D12, Vitamin D13, Vitamin D14, Vitamin D15, Vitamin D16, Vitamin D17, Vitamin D18, Vitamin D19, Vitamin D20, Vitamin D21, Vitamin D22, Vitamin D23, Vitamin D24, Vitamin D25, Vitamin D26, Vitamin D27, Vitamin D28, Vitamin D29, Vitamin D30, Vitamin D31, Vitamin D32, Vitamin D33, Vitamin D34, Vitamin D35, Vitamin D36, Vitamin D37, Vitamin D38, Vitamin D39, Vitamin D40, Vitamin D41, Vitamin D42, Vitamin D43, Vitamin D44, Vitamin D45, Vitamin D46, Vitamin D47, Vitamin D48, Vitamin D49, Vitamin D50, Vitamin D51, Vitamin D52, Vitamin D53, Vitamin D54, Vitamin D55, Vitamin D56, Vitamin D57, Vitamin D58, Vitamin D59, Vitamin D60.	

This Product Daily Intake is based on a 2,000 calorie diet. Actual intake may vary. Percent Daily Values are based on a diet of other people's secrets.

Other Ingredients: Sugar, Gelatin, Citric Acid, Natural Flavors, Stevia Leaf Extract, Vitamin E, Vitamin D3, Vitamin K1, Vitamin B12, Vitamin B6, Vitamin B9, Vitamin B5, Vitamin B3, Vitamin B1, Vitamin A, Vitamin K2, Vitamin D2, Vitamin D4, Vitamin D5, Vitamin D6, Vitamin D7, Vitamin D8, Vitamin D9, Vitamin D10, Vitamin D11, Vitamin D12, Vitamin D13, Vitamin D14, Vitamin D15, Vitamin D16, Vitamin D17, Vitamin D18, Vitamin D19, Vitamin D20, Vitamin D21, Vitamin D22, Vitamin D23, Vitamin D24, Vitamin D25, Vitamin D26, Vitamin D27, Vitamin D28, Vitamin D29, Vitamin D30, Vitamin D31, Vitamin D32, Vitamin D33, Vitamin D34, Vitamin D35, Vitamin D36, Vitamin D37, Vitamin D38, Vitamin D39, Vitamin D40, Vitamin D41, Vitamin D42, Vitamin D43, Vitamin D44, Vitamin D45, Vitamin D46, Vitamin D47, Vitamin D48, Vitamin D49, Vitamin D50, Vitamin D51, Vitamin D52, Vitamin D53, Vitamin D54, Vitamin D55, Vitamin D56, Vitamin D57, Vitamin D58, Vitamin D59, Vitamin D60.

www.paradisowellness.ca | Dr. Sous | www.drsous.ca

## CHAPTER IV. SYSTEMIC CONDITION RELATED TO KIDNEYS, LIVER & GALL BLADDER

### 1) KIDNEY STONE

Kidney stones (also called renal calculi, nephrolithiasis or urolithiasis) are hard deposits made of minerals and salts that form inside your kidneys. Diet, excess body weight, some medical conditions, and certain supplements and medications are among the many causes of kidney stones. Kidney stones can affect any part of your urinary tract — from your kidneys to your bladder. Often, stones form when the urine becomes concentrated, allowing minerals to crystallize and stick together.

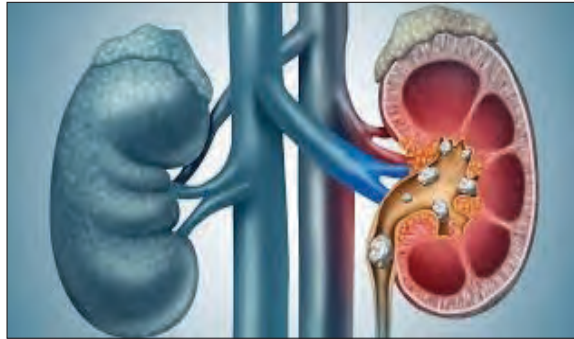

Passing kidney stones can be quite painful, but the stones usually cause no permanent damage if they're recognized in a timely fashion. Depending on your situation, you may need nothing more than to take pain medication and drink lots of water to pass a kidney stone. In other instances — for example, if stones become lodged in the urinary tract, are associated with a urinary infection or cause complications — surgery may be needed.

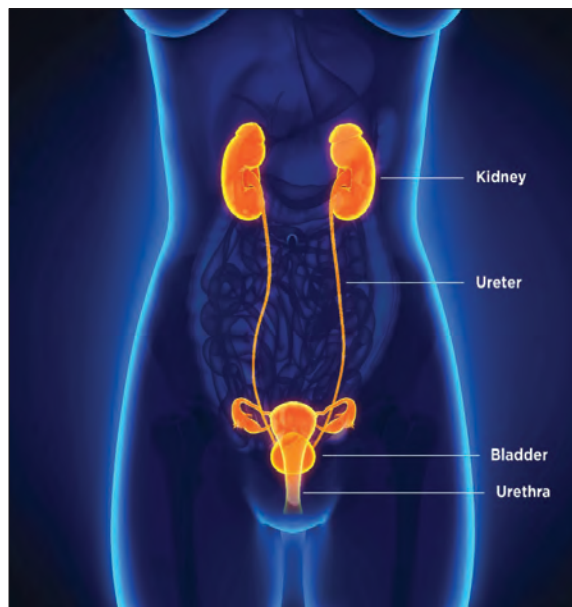

#### # Symptoms

A kidney stone usually will not cause symptoms until it moves around within the kidney or passes into one of the ureters. The ureters are the tubes that connect the kidneys and bladder.

If a kidney stone becomes lodged in the ureters, it may block the flow of urine and cause the kidney to swell and the ureter to spasm, which can be very painful. At that point, you may experience these symptoms:

- Severe, sharp pain in the side and back, below the ribs
- Pain that radiates to the lower abdomen and groin

- Pain that comes in waves and fluctuates in intensity
- Pain or burning sensation while urinating

**Other signs and symptoms may include:**

- Pink, red or brown urine
- Cloudy or foul-smelling urine
- A persistent need to urinate, urinating more often than usual or urinating in small amounts
- Nausea and vomiting
- Fever and chills if an infection is present

Pain caused by a kidney stone may change — for instance, shifting to a different location or increasing in intensity — as the stone moves through your urinary tract.

**The recommended supplements for Kidney stone are:** B-12 Drops, Magnesium Glycinate, Vitamin D3

**1. B-12 Drops**

B-12 Drops, which contain vitamin B-12, have been shown to provide several benefits for kidney stone patients. Firstly, vitamin B-12 is known to play a crucial role in maintaining the health of the urinary system. By taking B-12 Drops, individuals may experience improved kidney function and a reduced risk of developing kidney stones. Additionally, B-12 Drops can help in preventing the recurrence of kidney stones by promoting the breakdown and elimination of existing stones. Vitamin B-12 is also known for its pain-relieving properties, which can provide much-needed relief to individuals suffering from the excruciating pain associated with kidney stones. Moreover, B-12 Drops can boost overall energy levels and improve mood, which can be beneficial for kidney stone patients who often experience fatigue and mood swings due to their condition. Overall, incorporating B-12 Drops into a kidney stone treatment plan can potentially provide significant relief and support the overall well-being of individuals dealing with this challenging condition.



**2. Magnesium Glycinate**

Magnesium Glycinate is gaining popularity as a potential remedy for kidney stones. Kidney stones, which are hard deposits of minerals and salts that form in the kidneys, can cause excruciating pain and discomfort. They can be caused by various factors, including a high intake of oxalate-rich foods, inadequate fluid intake, and certain medical conditions. Magnesium Glycinate is a form of magnesium that is bound to the amino acid glycine, which enhances its absorption and bioavailability in the body. This compound is known for its ability to support kidney health and prevent the formation of kidney stones. One of the reasons why Magnesium Glycinate is believed to be effective for kidney stones is its ability to inhibit the crystallization of calcium oxalate, one of the most common types of kidney stones. By reducing the formation of these crystals, Magnesium Glycinate may help prevent the growth of kidney stones and potentially aid in their dissolution. Additionally, Magnesium Glycinate has been shown to have a diuretic effect, promoting increased urine pro-

duction and flushing out toxins from the kidneys, which can be beneficial in preventing the formation of kidney stones. Moreover, this compound has anti-inflammatory properties that may help alleviate the pain and inflammation associated with kidney stones. While Magnesium Glycinate shows promise as a natural approach to preventing and managing kidney stones, it is important to note that individual results may vary. It is always recommended to consult with a healthcare professional before starting any new supplement or treatment regimen, especially if you have a history of kidney stones or any underlying medical conditions.



### 3. Vitamin D3

Vitamin D3 has long been recognized for its crucial role in maintaining healthy bones and promoting calcium absorption. However, recent studies have also shed light on its potential benefits in preventing kidney stones. Kidney stones, also known as renal calculi, are solid crystalline deposits that form in the kidneys and can cause excruciating pain when they pass through the urinary tract. They are primarily composed of calcium oxalate or calcium phosphate. Vitamin D3, when converted into its active form, calcitriol, plays a critical role in regulating calcium levels in the body. By enhancing calcium absorption from the intestines and reducing calcium excretion through the kidneys, vitamin D3 helps maintain calcium balance. This is crucial because an excessive amount of calcium in the urine can contribute to the formation of kidney stones. Furthermore, vitamin D3 has been shown to reduce the production of a substance called oxalate, which is a key component of calcium oxalate stones. Oxalate is naturally present in many foods and can bind with calcium to form crystals. By decreasing oxalate production, vitamin D3 reduces the risk of crystal formation and subsequent stone development. Additionally, vitamin D3 has been found to have anti-inflammatory properties that can help alleviate the inflammatory response associated with kidney stone formation. Overall, while further research is needed to fully understand the mechanisms and optimal dosing of vitamin D3 for kidney stone prevention, its potential benefits make it a promising adjunct therapy for individuals prone to recurrent kidney stones.

**Ingredients:** see Supplement Facts.

**Manufacturer Country:** USA

**Product Amount:** 100 soft-gels

**Gross Weight:** 0.1lb (45g)

**Suggested Use:** As a dietary supplement, adults take one (1) soft-gel capsule daily or as directed by a health care professional. Store in a cool, dry place and away from direct light.



## 2) CHRONIC KIDNEY DISEASE

Chronic kidney disease (CKD) means your kidneys are damaged and can't filter blood the way they should. The main risk factors for developing kidney disease are diabetes, high blood pressure, heart disease, and a family history of kidney failure.

### #Symptoms

- Weight loss and poor appetite.
- Swollen ankles, feet or hands – as a result of water retention (oedema)
- Shortness of breath.
- Tiredness.
- Blood in your pee (urine)
- An increased need to pee – particularly at night.
- Difficulty sleeping (insomnia)
- Itchy skin.

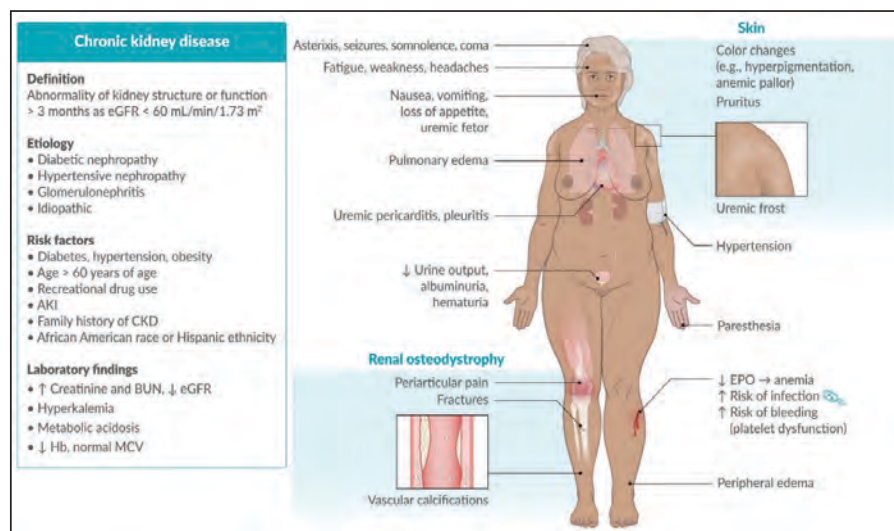

### Early stages of CKD

Kidney disease does not tend to cause symptoms when it's at an early stage. This is because the body is usually able to cope with a significant reduction in kidney function.

Kidney disease is often only diagnosed at this stage if a routine test for another condition, such as a blood or urine test, detects a possible problem.

If it's found at an early stage, medicine and regular tests to monitor it may help stop it becoming more advanced.

### Later stages of CKD

A number of symptoms can develop if kidney disease is not found early or it gets worse despite treatment. Symptoms can include:

- Weight loss and poor appetite
- Swollen ankles, feet or hands – as a result of water retention (oedema)
- Shortness of breath
- Tiredness
- Blood in your pee (urine)
- An increased need to pee – particularly at night
- Difficulty sleeping (insomnia)
- Itchy skin
- Muscle cramps



- Feeling sick
- Headaches

The recommended supplements for Chronic Kidney Disease are: Resveratrol,

### 1. Resveratrol

Resveratrol, a natural compound found in various plants, has gained significant attention in recent years for its potential benefits in managing chronic kidney disease (CKD). CKD is a progressive condition characterized by the gradual loss of kidney function, leading to various complications. Resveratrol has been extensively studied for its antioxidant, anti-inflammatory, and anti-fibrotic properties, which are crucial in the context of CKD. Studies have shown that resveratrol can help reduce oxidative stress, inflammation, and fibrosis in the kidneys, thereby slowing down the progression of CKD. Additionally, resveratrol has been found to have protective effects on renal cells, promoting their survival and preventing cell death. This compound also exhibits vasodilatory properties, which can improve blood flow to the kidneys and enhance renal function. Moreover, resveratrol has been shown to modulate various signaling pathways involved in CKD pathogenesis, such as the renin-angiotensin-aldosterone system and the nuclear factor-kappa B pathway. These actions contribute to the overall reno-protective effects of resveratrol.

**Ingredients:** see Supplement Facts.

**Manufacturer Country:** USA

**Product Amount:** 60 caps

**Gross Weight:** 0.25lb (113g)

**Suggested Use:** Take one (1) veggie capsule twice a day as a dietary supplement. For best results, take 20-30 min before a meal or as directed by your healthcare professional.

**Caution:** Do not exceed recommended dose. Pregnant or nursing mothers, children under the age of 18, and individuals with a known medical condition should consult a physician before using this or any dietary supplement.

**Warning:** This product is not intended to diagnose, treat, cure or prevent any disease. Keep out of reach of children. Do not use if the safety seal is damaged or missing. Store in a cool, dry place.

**DRSOUS.CA Resveratrol 50% 600mg Antioxidant**  
 Regular price \$28.00 CAD  
 Product Amount: 60 caps  
 Gross Weight: 0.25lb (113g)  
 Resveratrol is an antioxidant-like compound that promotes heart health, brain health and supports weight loss.

- Cardiovascular health
- Antioxidant
- Weight control
- Anti-aging

**Supplement Facts**  
 Serving Size: 1 Capsule  
 Servings Per Container: 60

	Amount Per % Daily Serving	Value
Resveratrol (Polyphenol capsaicin) (acid) (Complex Containing 50% Trans-Resveratrol)	600mg	**

\*\* % Daily Value not established  
 Other Ingredients: Vegetable Capsule (Cellulose), Microcrystalline Cellulose

A specific channel for Resveratrol on Youtube

Paradise Wellness | Dr. Sows | www.drsovs.ca

### 2. CoQ10

CoQ10, a naturally occurring antioxidant, plays a crucial role in energy production within cells and has been found to be deficient in individuals with CKD. Studies have shown that CoQ10 supplementation can improve kidney function, reduce inflammation, and decrease oxidative stress in CKD patients. Additionally, CoQ10 has been found to have a positive impact on blood pressure control, a common concern in individuals with CKD. Furthermore, research suggests that CoQ10 may help protect against kidney damage caused by certain medications, such as nonsteroidal anti-inflammatory drugs (NSAIDs) and certain antibiotics.

**Ingredients:** see Supplement Facts.

**Manufacturer Country:** USA

**Product Amount:** 30 caps

**Gross Weight:** 0.25lb (113g)

**Suggested Use:** Take one (1) capsule twice a day as a dietary supplement. For best results, take 20-30 min before a meal or as directed by your healthcare professional.

**Caution:** Do not exceed recommended dose. Pregnant or nursing mothers, children under the age of 18, and individuals with a known medical condition should consult a physician before using this or any dietary supplement.

**Warning:** Keep out of reach of children. Do not use if the safety seal is damaged or missing. Store in a cool, dry place.



### 3. Vitamin D3

Vitamin D3 plays a crucial role in maintaining bone health and calcium homeostasis, and its deficiency is commonly observed in CKD patients due to impaired kidney function. However, emerging research suggests that vitamin D3 supplementation may offer more than just skeletal benefits in this population. Studies have shown that vitamin D3 supplementation in CKD patients can help improve cardiovascular health by reducing blood pressure, decreasing arterial stiffness, and mitigating inflammation. Additionally, vitamin D3 has been linked to enhanced immune function, reduced proteinuria, and a possible protective effect against kidney fibrosis. These findings have sparked interest in the potential use of vitamin D3 as an adjunct therapy for CKD patients.

**Ingredients:** see Supplement Facts.

**Manufacturer Country:** USA

**Product Amount:** 100 soft-gels

**Gross Weight:** 0.1lb (45g)

**Suggested Use:** As a dietary supplement, adults take one (1) soft-gel capsule daily or as directed by a health care professional. Store in a cool, dry place and away from direct light.

**Warning:** Keep out of reach of children. Do not use if the safety seal is damaged or missing. Store in a cool, dry place.



### 3) KIDNEY INFECTION

A kidney infection is a type of urinary tract infection (UTI). A kidney infection may begin in the tube that carries urine from the body (urethra) or in the bladder. The infection can travel to one or both kidneys. A kidney infection is also called pyelonephritis.

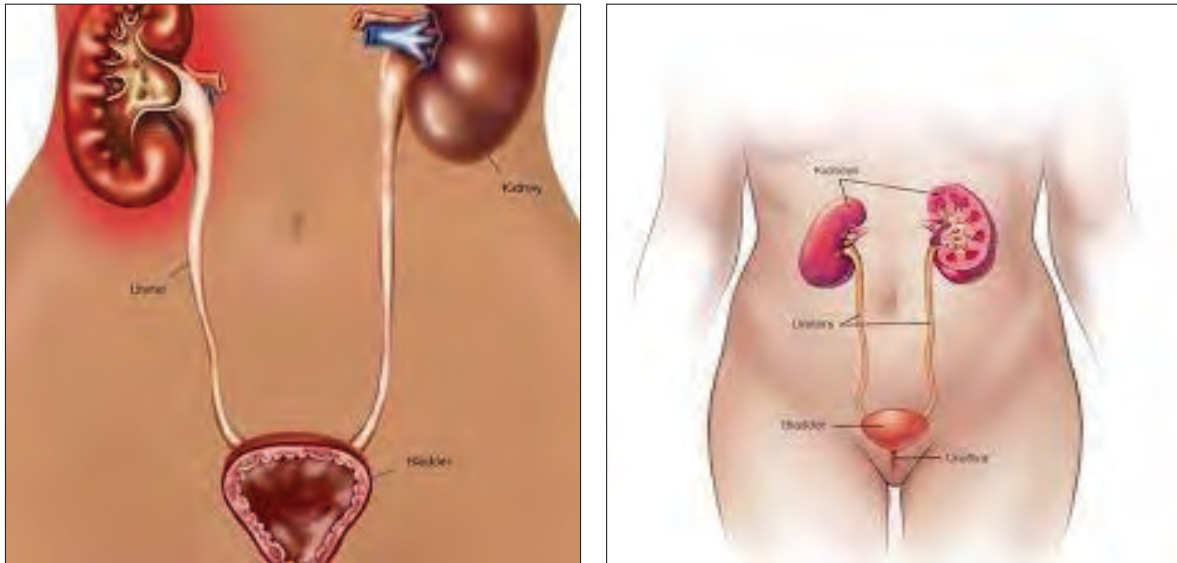

A kidney infection needs prompt medical treatment. If not treated properly, an infection can cause lasting damage to the kidneys. Or the bacteria can spread to the bloodstream and cause a dangerous infection. Kidney infection treatment often includes antibiotics, which might be given in the hospital.

#### # Symptoms

Symptoms of a kidney infection might include:

- Fever
- Chills
- A burning feeling or pain when urinating
- Having to urinate often
- A strong, lasting urge to urinate
- Back, side or groin pain
- Nausea and vomiting
- Pus or blood in the urine
- Urine that smells bad or is cloudy
- Belly pain

**The recommended supplements for Kidney Infection are:** Elderberry & Vitamin C, Bee Pearl Powder, & Probiotics.

#### 1. Elderberry & Vitamin C

When it comes to kidney infections, it's important to seek medical attention and follow the prescribed treatments. However, there are some supplements that may support kidney health and aid in the recovery process. Vitamin C is known for its immune-boosting properties, and a strong immune system is essential for fighting off infections, including kidney infections. Additionally, vitamin C has been found to have antimicrobial properties, which means it can help inhibit the growth of bacteria that cause UTIs. By increasing the acidity of urine, vitamin C creates an environment that is unfavorable for bacterial growth. Moreover, studies have shown that vitamin C can enhance the effectiveness of antibiotics used to treat kidney infections. It acts as a co-factor, helping antibiotics to penetrate bacterial cells and exert their antibacterial effects more efficiently. Furthermore, vitamin C has been shown to reduce inflammation in the body, which can be beneficial in alleviating the symptoms associated with kidney infections, such as pain and discomfort.

With these Elderberry and Vitamin C gummies, there is no need to worry about taking capsules or dealing with undesirable side effects such as digestive discomfort.

**Ingredients:** see Supplement Facts.

**Flavor:** Elderberry

**Manufacturer Country:** USA

**Product Amount:** 60 gummies

**Gross Weight:** 0.56lb (255g)

**Suggested Use:** Take two (2) gummies once a day as a dietary supplement.

**Caution:** Do not exceed recommended dose. Pregnant or nursing women, children under 18, and individuals with known medical conditions should consult their physician before taking.

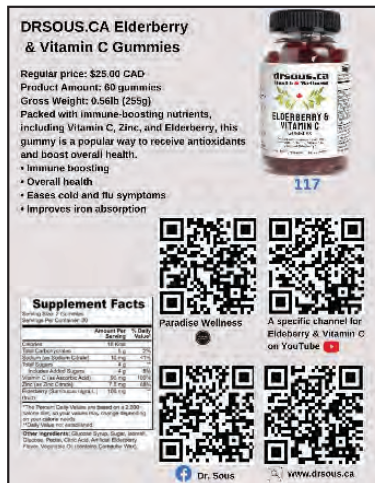

## 2. Bee Pearl Powder

While conventional treatments for kidney infections typically involve antibiotics, some individuals are turning to alternative therapies like bee pearl powder to complement their treatment plan. Bee pearl powder is a nutrient-rich substance produced by bees from the pollen they collect from flowers. It contains a wide range of vitamins, minerals, amino acids, and antioxidants that are believed to have numerous health benefits. When it comes to kidney infections, bee pearl powder is thought to possess anti-inflammatory properties that may help reduce inflammation in the kidneys and alleviate symptoms associated with the infection. Additionally, bee pearl powder is said to support the immune system, which plays a crucial role in fighting off infections.

**Bee bread:** Powerful blend of pollen, nectar, and enzymes packed with nutrients. Propolis (beeswax): Beeswax has been utilized for millennia due to its antiviral, antifungal, antibacterial, and anti-inflammatory qualities.

**Royal jelly:** High in vitamins & minerals, including the unique glycoproteins known as Major Royal Jelly Proteins (MRJPs).

Each box contains 30 easy-to-use sachets; add the powder to yogurt, smoothies, or cereal to reap the benefits of the natural bee product. One sachet of Bee Pearl Powder per day provides the optimal daily intake of vitamins, microelements, unsaturated fatty acids, polyphenols, and antioxidants.

**Ingredients:** see Supplement Facts.

**Manufacturer Country:** Latvia

**Product Amount:** 30 sachets

**Gross Weight:** 0.3lb (136g)

**Suggested Use:** Mix one sachet into your smoothie to experience all the health-giving and energy-boosting powers of bee bread, royal jelly, and propolis powder!

**Warning:** Recommended to anyone who is not allergic to bee products. Keep out of reach of children. Do not use if the safety seal is damaged or missing. Store in a cool, dry place.

**DrSous.ca Bee Pearl Powder**  
**Smoothie with Propolis Royal Jelly**  
 Regular price: \$44.45 CAD  
 Product Amount: 30 sachets

Bee Pearl Powder is pollen, nectar, and enzyme blend in powder form for an effortless addition to your favorite smoothies and other beverages. It is rich in vitamins, microelements, polyphenols, unsaturated fatty acids, and antioxidants. Each box contains 30 easy-to-use sachets; add the powder to yogurt, smoothies, or cereal to reap the benefits of the natural bee product.

- Anti-inflammatory
- Anti-fungal
- Effective immune-booster
- Promotes healthy gut flora

**Supplement Facts**

	Amount Per Serving	% Daily Value
Energy	100kcal	20%
Protein	10g	20%
Total Fat	10g	20%
Carbohydrate	10g	20%
Fiber	10g	20%
Sodium	10g	20%
Total Sugar	10g	20%
Total Fat (Saturated)	10g	20%
Cholesterol	10g	20%
Vitamin C	10g	20%

www.paradisewellness.ca A specific channel for Bee Pearl on YouTube

Dr. Sous | www.drsous.ca

### 3. Probiotics

While antibiotics are typically prescribed to treat kidney infections, research has shown that incorporating probiotics into the treatment plan may offer additional benefits. Probiotics are live microorganisms that, when consumed in adequate amounts, can confer health benefits to the host. They are commonly found in certain fermented foods, such as yogurt, kefir, and sauerkraut, or in the form of dietary supplements. These beneficial bacteria work by restoring the balance of the gut microbiota, which plays a crucial role in maintaining overall health. Studies have suggested that probiotics may help prevent recurrent urinary tract infections, including kidney infections, by inhibiting the growth of pathogenic bacteria in the urinary tract. By colonizing the gut and urinary tract with beneficial bacteria, probiotics can help strengthen the immune system and reduce the risk of infection. Furthermore, probiotics have been shown to have anti-inflammatory properties, which can be particularly beneficial for individuals with kidney infections, as inflammation is a hallmark of this condition.

Probiotic 40 Billion with Prebiotics is a blend of four probiotic strains: Lactobacillus Acidophilus, Bifidobacterium Lactis, Lactobacillus Plantarum, and Lactobacillus Paracasei.

Together, they provide a high level of beneficial bacteria to the gut to support a healthy metabolic response for both men and women.

**Ingredients:** See Supplement Facts.

**Manufacturer Country:** USA

**Product Amount:** 60 caps

**Gross Weight:** 0.25lb (113g)

**Suggested Use:** Take two (2) capsules once a day as a dietary supplement. For best results, take one (1) capsule during the day and one (1) capsule in the evening. Repeat the process daily. Do not exceed two capsules per day.

**Warning:** Keep out of reach of children. Do not use if the safety seal is damaged or missing. Store in a cool, dry place.

**DrSous.ca Probiotic 40 Billion with Prebiotics**  
 Regular price: \$27.00 CAD  
 Product Amount: 60 caps  
 Gross Weight: 0.25lb (113g)

Probiotic 40 Billion with Prebiotics is a blend of four probiotic strains: Lactobacillus Acidophilus, Bifidobacterium Lactis, Lactobacillus Plantarum, and Lactobacillus Paracasei. Together, they provide a high level of beneficial bacteria to the gut to support a healthy metabolic response for both men and women.

**Supplement Facts**

	Amount Per Serving	% Daily Value
Probiotic Blend (40 Billion CFU)	40 Billion CFU	100%
Lactobacillus Acidophilus	3.25B	100%
Bifidobacterium Lactis	2.0B	100%
Lactobacillus Plantarum	5.0-11B	100%
Lactobacillus Paracasei	5.0-11B	100%
Mariner Polysaccharide Complex	100mg	100%
Inulin	100mg	100%

Other Ingredients: Cellulose, Vegetable Cellulose, Rice Starch, Magnesium Stearate, Capsules

Dr. Sous | www.drsous.ca



#### 4) POLYCYSTIC KIDNEY

Polycystic kidney disease (PKD) is an inherited disorder in which clusters of cysts develop primarily within your kidneys, causing your kidneys to enlarge and lose function over time. Cysts are noncancerous round sacs containing fluid. The cysts vary in size, and they can grow very large. Polycystic kidney disease (PKD) is an inherited disorder in which clusters of cysts develop primarily within your kidneys, causing your kidneys to enlarge and lose function over time. Cysts are noncancerous round sacs containing fluid. The cysts vary in size, and they can grow very large.

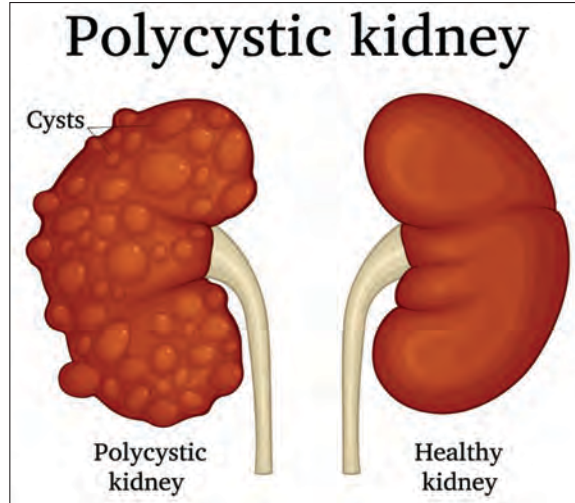

# **Symptoms:** Polycystic kidney disease symptoms can include:

- High blood pressure.
- Back or side pain.
- Blood in your urine.
- A feeling of fullness in your abdomen.
- Increased size of your abdomen due to enlarged kidneys.
- Headaches.
- Kidney stones.
- Kidney failure.

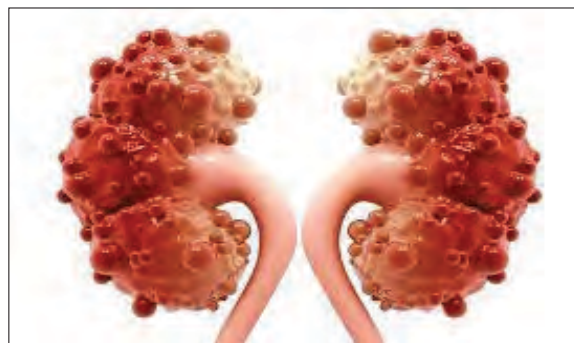

**The recommended supplements for Polycystic Kidney are:** CoQ10, B12 Drops, & Vitamin D3.

##### 1. CoQ10

PKD is a genetic disorder characterized by the formation of numerous cysts in the kidneys, leading to kidney enlargement and potential kidney failure over time. Although there is no known cure for PKD, research has suggested that CoQ10 supplementation may be beneficial in slowing down the progression of the disease and improving kidney function.

Studies have indicated that CoQ10 supplementation in individuals with PKD may help reduce oxidative stress and inflammation, which are key factors contributing to the development and progression of the disease. By neutralizing harmful free radicals and reducing inflammation, CoQ10 may help protect kidney cells from further damage and promote their overall health. Additionally, CoQ10 has been found to improve mitochondrial function, which is crucial for cellular energy production. This can potentially benefit individuals with PKD, as impaired mitochondrial function is believed to be involved in the pathogenesis of the disease.

Furthermore, CoQ10 has been shown to have a positive impact on blood pressure, another important aspect of PKD management. High blood pressure is a common complication of PKD and can further damage the kidneys. CoQ10 has the potential to lower blood pressure by promoting the dilation of blood vessels and improving endothelial function. By doing so, it may help reduce the risk of cardiovascular events and slow down the decline in kidney function.

**Ingredients:** See Supplement Facts.

**Manufacturer Country:** USA

**Product Amount:** 30 caps

**Gross Weight:** 0.25lb (113g)

**Suggested Use:** Take one (1) capsule twice a day as a dietary supplement. For best results, take 20-30 min before a meal or as directed by your healthcare professional.

**Caution:** Do not exceed recommended dose. Pregnant or nursing mothers, children under the age of 18, and individuals with a known medical condition should consult a physician before using this or any dietary supplement.

**Warning:** Keep out of reach of children. Do not use if the safety seal is damaged or missing. Store in a cool, dry place.



## 2. B-12 Drops

B-12, also known as vitamin B12, plays a crucial role in maintaining overall health and wellness. While its primary function is often associated with the production of red blood cells and proper nerve function, recent research suggests that B-12 may have potential benefits for individuals with polycystic kidney disease (PKD). PKD is a genetic disorder characterized by the growth of numerous fluid-filled cysts in the kidneys, leading to impaired kidney function over time. Studies have shown that individuals with PKD often have lower levels of vitamin B-12 compared to those without the condition. This deficiency may be due to malabsorption issues or altered metabolism in PKD patients. B-12 supplementation has been found to help in multiple ways. Firstly, it can improve energy levels and reduce fatigue, which can be particularly beneficial for PKD patients who often experience low energy due to the disease itself or associated complications. Additionally, B-12 has been found to support kidney health by reducing inflammation and oxidative stress, both of which are important factors in the progression of PKD. Furthermore, B-12 supplementation may help prevent or minimize anemia, a common complication of PKD that occurs as a result of decreased production of red blood cells. Anemia can worsen the symptoms of PKD, including fatigue, weakness, and shortness of breath. Therefore, ensuring adequate B-12 levels through supplementation or dietary sources can be essential for individuals with PKD. However, it is important to consult with a healthcare professional before starting

any supplementation regimen, as they can provide personalized advice based on an individual's specific needs and medical history.

157

**B-12 Drops**

B12 complex contains: Riboflavin-required for the proper development and function of the skin, lining of the digestive tract, Nicotin-required for the proper function of fats and sugars in the body and to maintain healthy tissue, Vitamin B6-needed to maintain proper energy levels. B12 is a critical vitamin that is required for proper development of many body systems and tissues. Deficiency of B12 can lead to many problems such as memory loss and fatigue.

Paradise Wellness

A specific channel for B-12 Drops on YouTube

Dr. Sous | www.drsous.ca

### 3. Vitamin D3

In recent years, there has been growing interest in the potential role of vitamin D3 in the management of PKD. Studies have suggested that vitamin D3 may have beneficial effects on PKD. One of the main mechanisms by which it may exert its effects is through its anti-inflammatory properties. Chronic inflammation is a key driver of the progression of PKD, and by reducing inflammation, vitamin D3 may help slow down the growth of cysts and preserve kidney function. Furthermore, vitamin D3 has been shown to have a protective effect on renal fibrosis, which is a common complication of PKD characterized by the excessive deposition of collagen in the kidneys.

Another potential benefit of vitamin D3 in PKD is its role in regulating blood pressure. Hypertension is a common comorbidity in individuals with PKD and can further worsen kidney function. Vitamin D3 has been shown to help regulate blood pressure by inhibiting the renin-angiotensin-aldosterone system, a hormone system that plays a crucial role in blood pressure regulation. By modulating this system, vitamin D3 may help lower blood pressure and reduce the risk of cardiovascular complications in individuals with PKD. In addition to its anti-inflammatory and blood pressure-regulating effects, vitamin D3 may also have a role in modulating the growth and proliferation of cysts in PKD. Several studies have suggested that vitamin D3 may inhibit the proliferation of cyst-lining cells and reduce the secretion of fluid into the cysts. This could potentially slow down the growth of cysts and delay the progression of PKD.

**Ingredients:** See Supplement Facts.

**Manufacturer Country:** USA

**Product Amount:** 100 soft-gels

**Gross Weight:** 0.1lb (45g)

**Suggested Use:** As a dietary supplement, adults take one (1) soft-gel capsule daily or as directed by a health care professional. Store in a cool, dry place and away from direct light.

**Warning:** Keep out of reach of children. Do not use if the safety seal is damaged or missing.

Store in a cool, dry place.

DRSOUS.CA Vitamin D3 helps maintain bone density, strength and healthy cell growth

Vitamin D3 is a fat-soluble vitamin that supports the growth and development of bones and teeth. It also plays an essential role in the functioning of the muscles and boosting energy levels in the body. The body naturally produces Vitamin D when exposed to sunlight, and you can also receive Vitamin D from some foods like oily fish. In the winter months, especially in colder regions, the body doesn't produce as much vitamin D, which can lead to what's called 'seasonal depression.'

www.paradisewellness.ca

A specific channel for Supplements on YouTube

Dr. Sous | www.drsous.ca

154



## 5) INFLAMMATION OF THE LIVER

Hepatitis means inflammation of the liver. The liver is a vital organ that processes nutrients, filters the blood, and fights infections. When the liver is inflamed or damaged, its function can be affected. Heavy alcohol use, toxins, some medications, and certain medical conditions can cause hepatitis. However, hepatitis is often caused by a virus. In the United States, the most common types of viral hepatitis are hepatitis A, hepatitis B, and hepatitis C. Many people with hepatitis do not have symptoms and do not know they are infected. If symptoms occur with an acute infection, they can appear anytime from 2 weeks to 6 months after exposure. Symptoms of acute hepatitis can include fever, fatigue, loss of appetite, nausea, vomiting, abdominal pain, dark urine, light-colored stools, joint pain, and jaundice. Symptoms of chronic viral hepatitis can take decades to develop.

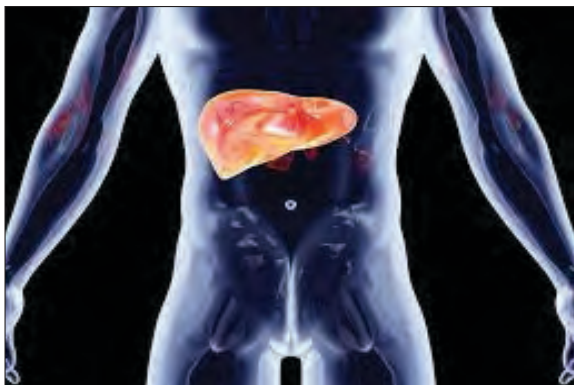

### # Symptoms

- Feelings of fatigue.
- Jaundice (a condition that causes your skin and the whites of your eyes to turn yellow)
- Feeling full quickly after a meal.
- Nausea.
- Vomiting.
- Pain in the abdomen.

**Causes:** Liver disease has many causes.

### Infection

Parasites and viruses can infect the liver, causing inflammation that reduces liver function. The viruses that cause liver damage can be spread through blood or semen, contaminated food or water, or close contact with a person who is infected. The most common types of liver infection are hepatitis viruses, including:

1. Hepatitis A
2. Hepatitis B
3. Hepatitis C

**The recommended supplement for liver inflammation/ hepatitis are:** Platinum Turmeric, Resveratrol, & Super Fat Burner.

### 1. Platinum Turmeric

Platinum Turmeric is a natural remedy that has gained significant attention for its potential benefits in reducing inflammation of the liver. The liver plays a crucial role in detoxification, metabolism, and overall bodily function. However, various factors such as excessive alcohol consumption, viral infections, or certain medications can lead to liver inflammation, also known as hepatitis. Inflammation of the liver can cause discomfort, fatigue, and even long-term damage if left untreated. Turmeric, a vibrant yellow spice commonly used in Asian cuisine, contains a compound called curcumin, which has potent anti-inflammatory properties. Curcumin has been extensively studied for its ability to reduce inflammation in various parts of the body, including the liver. It works by suppressing the

production of inflammatory molecules and inhibiting the activation of certain immune cells involved in the inflammatory response. By incorporating Platinum Turmeric into one's daily routine, individuals with liver inflammation may benefit from its potential to alleviate symptoms and promote liver health. Our Platinum Turmeric blend contains various forms of turmeric, glucosamine, Boswellia extract (frankincense), piperine, and several other highly beneficial natural extracts to keep you at your best. Natural extracts have been used for centuries in Ayurvedic medicine to remedy illnesses. We harness and advance these natural extracts in modern times for optimal bioavailability and effectiveness.

**Ingredients:** see Supplement Facts.

**Manufacturer Country:** USA

**Product Amount:** 60 caps

**Gross Weight:** 0.25lb (113g)

**Suggested Use:** Take two (2) capsules once a day as a dietary supplement. For best results, take 20-30 min before a meal or as directed by your healthcare professional.



## 2. Resveratrol

Resveratrol is a plant compound with potent antioxidant functionality. Resveratrol is found mainly in red wine, red grapes, berries, and peanuts. It is most concentrated in the skin of grape skins and seeds.

Recent studies have suggested that resveratrol possesses anti-inflammatory properties that may help alleviate liver inflammation. Resveratrol is believed to inhibit the production and release of pro-inflammatory molecules, such as cytokines and chemokines, thereby reducing the overall inflammatory response. Additionally, resveratrol has been found to activate certain signaling pathways that promote the production of anti-inflammatory molecules, thus further contributing to its potential beneficial effects on liver inflammation. Moreover, resveratrol has been shown to possess antioxidant properties, which can help neutralize harmful free radicals and protect liver cells from oxidative stress, a common feature of liver inflammation. Furthermore, resveratrol has been found to modulate various cellular processes involved in liver inflammation, including the activation of immune cells, regulation of cell death, and inhibition of fibrosis formation. While research on the effects of resveratrol on liver inflammation is still in its early stages, preliminary findings are promising and suggest that resveratrol may indeed hold therapeutic potential for managing inflammation of the liver.

**Ingredients:** see Supplement Facts.

**Manufacturer Country:** USA

**Product Amount:** 60 caps

**Gross Weight:** 0.25lb (113g)

**Suggested Use:** Take one (1) veggie capsule twice a day as a dietary supplement. For best results, take 20-30 min before a meal or as directed by your healthcare professional.

**Caution:** Do not exceed recommended dose. Pregnant or nursing mothers, children under the age of 18, and individuals with a known

medical condition should consult a physician before using this or any dietary supplement.

**Warning:** This product is not intended to diagnose, treat, cure or prevent any disease. Keep out of reach of children. Do not use if the safety seal is damaged or missing. Store in a cool, dry place.



### 3. Super Fat Burner

Super Fat Burner with MCT combines Vitamin C, Vitamin B6, Choline, Chromium, L-Carnitine, and medium-chain triglycerides (MCT). Choline, a water-soluble vitamin-like nutrient, plays a crucial role in liver function and metabolism. It aids in the transportation of fat from the liver and prevents the accumulation of fat, thus reducing inflammation. Chromium, an essential trace mineral, has been found to enhance insulin sensitivity and regulate blood sugar levels. By maintaining stable blood sugar levels, chromium can help prevent liver inflammation associated with insulin resistance and diabetes. L-carnitine, an amino acid-like compound, is known for its role in fatty acid metabolism. It helps transport fatty acids into the mitochondria, the energy-producing centers of cells, where they are burned for fuel. By promoting fat metabolism, L-carnitine can help reduce fat accumulation in the liver and alleviate inflammation. Lastly, medium-chain triglycerides (MCTs) are a type of dietary fat that is rapidly absorbed and metabolized by the liver, providing a quick source of energy. MCTs have been shown to reduce liver fat accumulation and inflammation, making them a potential therapeutic option for liver health. While these nutrients and supplements show promise in reducing liver inflammation, it is important to consult with a healthcare professional before incorporating them into your diet or treatment plan.

**Ingredients:** see Supplement Facts.

**Manufacturer Country:** USA

**Product Amount:** 90 capsules.

**Gross Weight:** 0.2lb (90.7g)

**Suggested Use:** 2 capsules daily, preferably with meals or as directed by a healthcare professional. For best results, take 1 capsule with 8 ounces of water before breakfast and again before dinner. This product should be used in conjunction with a sensible diet and exercise program.

**Caution:** Do not exceed recommended dose. Avoid taking this product in conjunction with other dietary supplements containing high elemental chromium levels. This product is not intended for pregnant or nursing mothers or children under the age of 18. If you are diabetic or have a known medical condition, consult your physician before taking this or any dietary supplement. This product is manufactured and packaged in a facility that may also process milk, soy, wheat, egg, peanuts, tree nuts, fish, and crustacean shellfish.

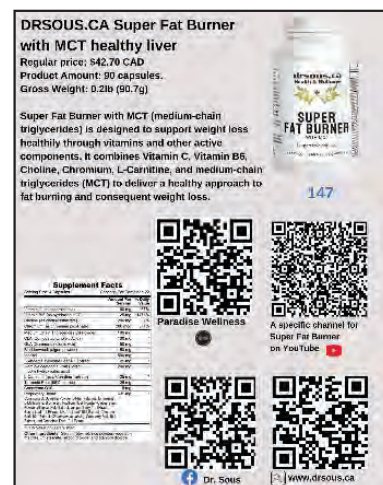

#### 4. Ultra Cleanse Smoothie

The Ultra Cleanse Smoothie is a powerful and natural remedy specifically designed to combat inflammation of the liver. The liver plays a crucial role in detoxifying the body, but it can become overwhelmed by toxins, leading to inflammation and potential damage. This smoothie is packed with ingredients that are known for their anti-inflammatory properties, making it an excellent choice for those looking to support liver health. The key ingredients include organic grasses, superfoods, B-Vitamins, and botanical extracts designed to fuel the body with broad-spectrum nutrients which are rich in antioxidants that help reduce inflammation.

Furthermore, the Ultra Cleanse Smoothie incorporates ginger, another powerful anti-inflammatory ingredient that aids in digestion and supports the liver's natural detoxification process. To enhance the flavor and nutritional value, this smoothie also includes a variety of fruits like pineapple, which contains bromelain, an enzyme known to reduce liver inflammation. This whole-food blend empowers the body through fruits and vegetables, organic grasses, adaptogens, immune-boosting herbs, plant extracts, and enzymes.

**Ingredients:** see Supplement Facts.

**Flavor:** Mix of herbs, vegetables, and fruits

**Manufacturer Country:** USA

**Product Amount:** 0.55lb (250g)

**Gross Weight:** 0.67lb (304g)

**Suggested Use:** Adults mix two (2) teaspoons into 8 oz. of apple juice or other favorite liquid, or use as directed by a health care professional. Store in a cool, dry place and away from direct light. Great with apple juice.

**Caution:** Consult your physician before using this product if you are pregnant or nursing, taking medications, or have a medical condition. Discontinue use two weeks before surgery.

**Warning:** Keep out of reach of children. Do not use if the safety seal is damaged or missing. Store in a cool, dry place.

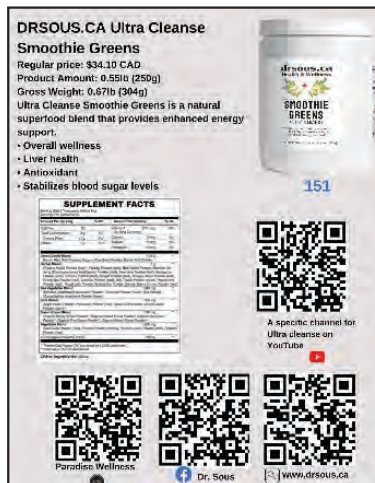

#### 6) FATTY LIVER DISEASE

Non-alcoholic fatty liver disease (NAFLD) is an umbrella term for a range of liver conditions affecting people who drink little to no alcohol. As the name implies, the main characteristic of NAFLD is too much fat stored in liver cells.

NAFLD is increasingly common around the world, especially in Western nations. In the United States, it is the most common form of chronic liver disease, affecting about one-quarter of the population.

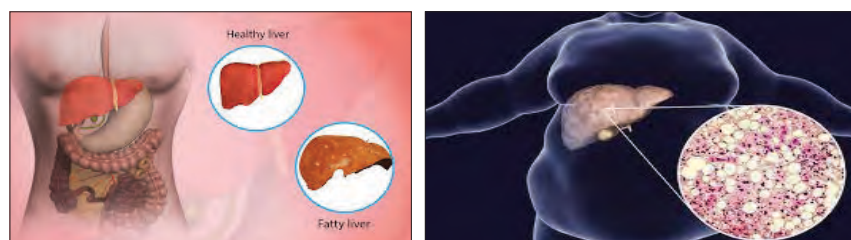

Some individuals with NAFLD can develop non-alcoholic steatohepatitis (NASH), an aggressive form of fatty liver disease, which is marked by liver inflammation and may progress to advanced scarring (cirrhosis) and liver failure. This damage is similar to the damage caused by heavy alcohol use.

## # Symptoms

NAFLD usually causes no signs and symptoms. When it does, they may include:

- Fatigue
- Pain or discomfort in the upper right abdomen
- Possible signs and symptoms of NASH and advanced scarring (cirrhosis) include:
  - Abdominal swelling (ascites)
  - Enlarged blood vessels just beneath the skin's surface
  - Enlarged spleen
  - Red palms
  - Yellowing of the skin and eyes (jaundice)

**The recommended supplements for fatty liver disease are:** Organic Spirulina, Vitamin D3, & Platinum Turmeric.

## 1. Spirulina

Spirulina is a blue-green algae known for its high protein level and dense nutrient content. It is one of the world's most well-known health supplements and has been consumed for centuries. One natural remedy that has gained attention for its potential benefits in managing fatty liver is organic spirulina. Spirulina is a type of blue-green algae that is rich in nutrients and antioxidants. It is packed with vitamins, minerals, and essential amino acids that contribute to its potential health benefits. When it comes to fatty liver, organic spirulina is believed to be beneficial due to its ability to reduce inflammation and oxidative stress in the liver. It contains phycocyanin, a powerful antioxidant that has been shown to have hepatoprotective effects. Additionally, spirulina has been found to have lipid-lowering properties, which may help in reducing the accumulation of fat in the liver. Furthermore, organic spirulina has been shown to improve liver function and enhance the body's natural detoxification processes. It aids in the removal of toxins and harmful substances from the liver, promoting overall liver health. While organic spirulina shows promise in supporting liver health and managing fatty liver disease, it is important to note that it should not replace medical treatment or a healthy lifestyle.

Our Organic Spirulina Powder is rich in essential amino acids lysine, methionine, cysteine, threonine, and phenylalanine which are crucial for supporting regular body functions. Furthermore, Spirulina has very high levels of iron, beta-carotene, and B vitamins. Spirulina is the perfect addition to your favorite smoothies and smoothie bowls.

**DrSous.Ca Organic Spirulina Powder 120g**

Regular price: \$15.00 CAD  
Product Amount: 0.26lb (120g)  
Gross Weight: 0.27lb (125g)

Spirulina is a blue-green algae known for its high protein level and dense nutrient content. Our Organic Spirulina Powder is rich in essential amino acids lysine, methionine, cysteine, threonine, and phenylalanine which are crucial for supporting regular body functions. It is anti-aging & anti-inflammatory.

**Supplement Facts**  
Serving Size: 1 Scoop only  
Amount Per Scoop

	Amount Per Scoop	% Daily Value*
Vitamin A	500 mcg	100%
Vitamin C	30 mg	50%
Resveratrol	20 mg	100%
Resveratrol	5.0 mg	100%
Resveratrol	1.0 mg	100%
Vitamin B12	5.0 mcg	100%
Iron	5.0 mg	100%
Phosphorus	50 mg	100%
Calcium	50 mg	100%
Magnesium	50 mg	100%
Copper	5.0 mg	100%
Zinc	5.0 mg	100%
Selenium	5.0 mcg	100%

\*Percent Daily Values are based on a diet of other people's secrets.

**Paradise Wellness**  
A specific channel for Spirulina on YouTube

Dr. Sous  
www.drsous.ca

## 2. Vitamin D3

Fatty liver, also known as hepatic steatosis, is a condition characterized by the accumulation of excess fat in the liver. This condition

is often associated with obesity, diabetes, and metabolic syndrome. Research suggests that vitamin D3, a form of vitamin D that is synthesized in the skin upon exposure to sunlight, may play a crucial role in the prevention and treatment of fatty liver. One of the key mechanisms through which vitamin D3 exerts its effects on fatty liver is by promoting the expression of genes involved in fat metabolism. Studies have shown that vitamin D3 supplementation can increase the expression of genes that facilitate the breakdown of triglycerides, the main type of fat stored in the liver. By enhancing the breakdown of triglycerides, vitamin D3 may help reduce the accumulation of fat in the liver, thus alleviating fatty liver disease. Moreover, vitamin D3 has been shown to have anti-inflammatory properties. Chronic inflammation is a hallmark of fatty liver disease and is believed to contribute to the progression of the condition. By modulating the immune response and reducing inflammation, vitamin D3 may help mitigate the damage caused by fatty liver disease. Another important aspect of vitamin D3's role in fatty liver disease is its potential impact on insulin resistance. Insulin resistance, a condition in which the body's cells become less responsive to the hormone insulin, is closely linked to the development of fatty liver. Emerging evidence suggests that vitamin D3 may improve insulin sensitivity, thereby reducing the risk of fatty liver and its associated complications.

**Ingredients:** see Supplement Facts.

**Manufacturer Country:** USA

**Product Amount:** 100 soft-gels

**Gross Weight:** 0.1lb (45g)

**Suggested Use:** As a dietary supplement, adults take one (1) soft-gel capsule daily or as directed by a health care professional. Store in a cool, dry place and away from direct light.

**Warning:** Keep out of reach of children. Do not use if the safety seal is damaged or missing. Store in a cool, dry place.



### 3. Platinum Turmeric

Platinum Turmeric, called curcumin, has been extensively studied for its anti-inflammatory and antioxidant properties. These properties are believed to play a crucial role in reducing liver inflammation and oxidative stress, which are key factors in the development and progression of fatty liver disease. Additionally, curcumin has been found to enhance the breakdown and clearance of fat from the liver, thus potentially reversing the fatty liver condition. Several studies have demonstrated the potential of Platinum Turmeric in reducing liver enzyme levels, improving liver function, and decreasing liver fat accumulation. Moreover, curcumin has been shown to have protective effects against liver damage caused by toxins and alcohol. However, it is important to note that while Platinum Turmeric shows promise in managing fatty liver disease, it should not be considered a standalone treatment. Lifestyle modifications, such as maintaining a healthy weight, adopting a balanced diet, regular exercise, and limiting alcohol intake, are also crucial for the management of fatty liver. Our Platinum Turmeric blend contains various forms of turmeric, glucosamine, Boswellia extract (frankincense), piperine, and several other highly beneficial natural extracts to keep you at your best. Natural extracts have been used for centuries in Ayurvedic medicine to remedy illnesses. We harness and advance these natural extracts in modern times for optimal bioavailability and effectiveness.



What are the symptoms of cirrhosis?

You may have no signs or symptoms of cirrhosis until your liver is badly damaged.

Early symptoms of cirrhosis may include

- feeling tired or weak
- poor appetite
- losing weight without trying
- nausea and vomiting
- mild pain or discomfort in the upper right side of your abdomen

As liver function gets worse, you may have other symptoms, including

- bruising and bleeding easily
- confusion, difficulties thinking, memory loss, personality changes, or sleep disorders
- swelling in your lower legs, ankles, or feet, called edema
- bloating from buildup of fluid in your abdomen, called ascites
- severe itchy skin
- darkening of the color of your urine
- yellowish tint to the whites of your eyes and skin, called jaundice

The recommended supplements for Cirrhosis are: Organic Spirulina, Super Fat Burner, Ultra Cleanse Smoothie.

### 1. Organic Spirulina

Organic spirulina, a type of blue-green algae, is rich in essential nutrients, including vitamins, minerals, antioxidants, and amino acids. These nutrients play a crucial role in promoting liver health and supporting the body's natural detoxification processes. Studies have suggested that organic spirulina may have hepatoprotective properties, meaning it helps protect the liver from damage. It contains phycocyanin, a pigment with potent antioxidant and anti-inflammatory properties. These properties may help reduce oxidative stress and inflammation in the liver, which are key factors contributing to the progression of cirrhosis. Additionally, organic spirulina has been found to enhance the production of certain enzymes that aid in the detoxification of harmful substances in the liver. Furthermore, organic spirulina is known to support the immune system. Individuals with cirrhosis often have a weakened immune system, making them more susceptible to infections. The immune-boosting effects of organic spirulina can help strengthen the body's defense mechanisms, reducing the risk of infections and improving overall health. Another benefit of organic spirulina for cirrhosis is its potential to improve energy levels and reduce fatigue. Cirrhosis can cause fatigue and weakness due to the liver's reduced ability to store and release energy. Organic spirulina is a nutrient-dense food that provides a natural energy boost, thanks to its high content of vitamins, minerals, and amino acids.

Spirulina is the perfect addition to your favorite smoothies and smoothie bowls.

**Ingredients:** see Supplement Facts.

**Manufacturer Country:** USA

**Product Amount:** 0.26lb (120g)

**Gross Weight:** 0.27lb (125g)

**Suggested Use:** The recommended starting dosage is ½ teaspoon a day, gradually increasing to 3 teaspoons, taken with food or around an hour before mealtimes.

**Warning:** Keep out of reach of children. Do not use if the safety seal is damaged or missing. Store in a cool, dry place.

**DrSous.Ca Organic Spirulina Powder 120g**

Regular price: \$15.00 CAD  
Product Amount: 0.26lb (120g)  
Gross Weight: 0.27lb (125g)

Spirulina is a blue-green algae known for its high protein level and dense nutrient content. Our Organic Spirulina Powder is rich in essential amino acids: lysine, methionine, cysteine, threonine, and phenylalanine which are crucial for supporting regular body functions. It is anti-aging & anti-inflammatory.

**Supplement Facts**

	Amount Per Serving	% Daily Value
Protein	56g (112g)	112%
Fiber	2g (4g)	4%
Iron	10mg (200mg)	200%
Calcium	100mg (2000mg)	2000%
Phosphorus	100mg (2000mg)	2000%
Magnesium	100mg (2000mg)	2000%
Copper	2.5mg (50mg)	50%
Manganese	1.5mg (30mg)	30%
Zinc	10mg (200mg)	200%

100% Daily Values are based on a diet of other people's secrets.

Ingredients: 100% Organic Spirulina Powder (120g net weight)

Dr. Sous | www.drSous.ca



## 2. Super Fat Burner

Super Fat Burner with MCT is a powerful supplement that offers a unique combination of essential vitamins and nutrients to support fat burning and promote overall well-being. This innovative formula contains a synergistic blend of Vitamin C, Vitamin B6, Choline, Chromium, L-Carnitine, and is specifically designed to address the needs of individuals looking to enhance their weight loss efforts. Vitamin C, a potent antioxidant, plays a crucial role in supporting a healthy immune system and promoting collagen synthesis, which is essential for optimal tissue repair. Vitamin B6, another important component of this supplement, is involved in numerous metabolic processes, including the breakdown of carbohydrates and fats. Choline, a nutrient similar to B vitamins, is known for its role in maintaining healthy liver function and lipid metabolism. Chromium, an essential trace mineral, has been shown to help regulate blood sugar levels and reduce cravings, making it a valuable addition to any weight management regimen. L-Carnitine, an amino acid-like compound, plays a crucial role in energy production by facilitating the transport of fatty acids into the mitochondria, where they can be burned for fuel. Lastly, the inclusion of ingredients specifically targeted for cirrhosis highlights the comprehensive nature of this supplement, which aims to support liver health and aid in the management of this condition.

**Ingredients:** see Supplement Facts.

**Manufacturer Country:** USA

**Product Amount:** 90 capsules.

**Gross Weight:** 0.2lb (90.7g)

**Suggested Use:** 2 capsules daily, preferably with meals or as directed by a healthcare professional. For best results, take 1 capsule with 8 ounces of water before breakfast and again before dinner. This product should be used in conjunction with a sensible diet and exercise program.

**Caution:** Do not exceed recommended dose. Avoid taking this product in conjunction with other dietary supplements containing high elemental chromium levels. This product is not intended for pregnant or nursing mothers or children under the age of 18. If you are diabetic or have a known medical condition, consult your physician before taking this or any dietary supplement. This product is manufactured and packaged in a facility that may also process milk, soy, wheat, egg, peanuts, tree nuts, fish, and crustacean shellfish.

**DRSOUS.CA Super Fat Burner with MCT healthy liver**  
Regular price: \$42.70 CAD  
Product Amount: 90 capsules.  
Gross Weight: 0.2lb (90.7g)

Super Fat Burner with MCT (medium-chain triglycerides) is designed to support weight loss healthily through vitamins and other active components. It combines Vitamin C, Vitamin B6, Choline, Chromium, L-Carnitine, and medium-chain triglycerides (MCT) to deliver a healthy approach to fat burning and consequent weight loss.

Supplement Facts	
Amount Per Serving	
Vitamin C (Ascorbic Acid)	1000mg
Vitamin B6 (Pyridoxine HCl)	100mg
Choline (Choline Bitartrate)	1000mg
Chromium (Chromium Picolinate)	1000mcg
L-Carnitine (L-Carnitine Bitartrate)	1000mg
Medium-Chain Triglycerides (MCT)	1000mg
Other Ingredients	
Contains 90 capsules.	

Paradise Wellness  
A specific channel for Super Fat Burner on YouTube

Dr. Sous | www.drsous.ca

## 3. Ultra Cleanse Smoothie

Cirrhosis is a serious condition in which the liver becomes scarred and damaged, leading to a compromised ability to function properly. This smoothie is specifically formulated to provide essential nutrients and antioxidants that can help reduce inflammation, promote liver regeneration, and support overall liver function.

The Ultra Cleanse Smoothie is a powerful and natural remedy specifically designed to combat inflammation of the liver. The liver plays a crucial role in detoxifying the body, but it can become overwhelmed by toxins, leading to inflammation and potential damage. This smoothie is packed with ingredients that are known for their anti-inflammatory properties, making it an excellent choice for those looking to support liver health. The key ingredients include organic grasses, superfoods, B-Vitamins, and botanical extracts designed

to fuel the body with broad-spectrum nutrients which are rich in antioxidants that help reduce inflammation. Furthermore, the Ultra Cleanse Smoothie incorporates ginger, another powerful anti-inflammatory ingredient that aids in digestion and supports the liver's natural detoxification process. To enhance the flavor and nutritional value, this smoothie also includes a variety of fruits like pineapple, which contains bromelain, an enzyme known to reduce liver inflammation. This whole-food blend empowers the body through fruits and vegetables, organic grasses, adaptogens, immune-boosting herbs, plant extracts, and enzymes.

**Ingredients:** see Supplement Facts.

**Flavor:** Mix of herbs, vegetables, and fruits

**Manufacturer Country:** USA

**Product Amount:** 0.55lb (250g)

**Gross Weight:** 0.67lb (304g)

**Suggested Use:** Adults mix two (2) teaspoons into 8 oz. of apple juice or other favorite liquid, or use as directed by a health care professional. Store in a cool, dry place and away from direct light. Great with apple juice.

**Caution:** Consult your physician before using this product if you are pregnant or nursing, taking medications, or have a medical condition. Discontinue use two weeks before surgery.

**Warning:** Keep out of reach of children. Do not use if the safety seal is damaged or missing. Store in a cool, dry place.



## 8. GALLSTONE

Gallstones are hard, pebble-like pieces of material, usually made of cholesterol or bilirubin that develops in your gallbladder. When gallstones block your bile ducts, they can cause sudden pain, which means you need medical attention right away. If left untreated, they can cause complications.

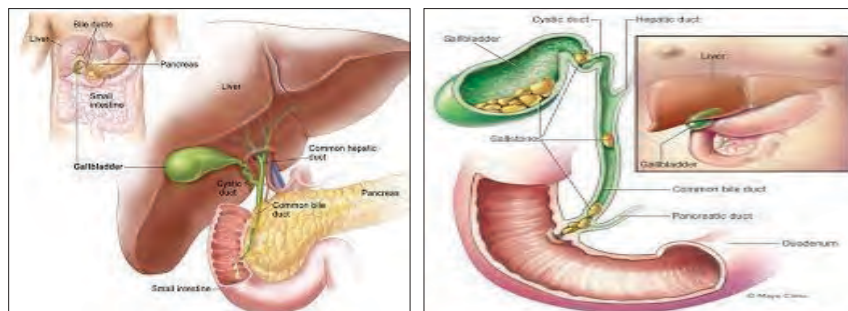

**What causes gallstones?** Gallstones may form if bile contains too much cholesterol, too much bilirubin, or not enough bile salts. Researchers do not fully understand why these changes in bile occur. Gallstones also may form if the gallbladder does not empty completely or often enough.



## 2. Probiotics

Traditional treatment methods for gallstones include surgery or medication, but there is growing evidence that probiotics may offer a natural and effective alternative. Probiotics are live bacteria and yeasts that are beneficial to our health, particularly our digestive system. They help maintain a healthy balance of bacteria in the gut, which is crucial for proper digestion and overall well-being. Studies have shown that certain strains of probiotics, such as Lactobacillus and Bifidobacterium, can help prevent the formation of gallstones by improving bile flow and reducing cholesterol levels. Additionally, probiotics have been found to have anti-inflammatory properties, which can help alleviate the inflammation associated with gallstones. While further research is still needed to fully understand the mechanisms and optimal dosage of probiotics for gallstones, the initial findings are promising.

**Ingredients:** See Supplement Facts.

**Manufacturer Country:** USA

**Product Amount:** 60 caps

**Gross Weight:** 0.25lb (113g)

**Suggested Use:** Take two (2) capsules once a day as a dietary supplement. For best results, take one (1) capsule during the day and one (1) capsule in the evening. Repeat the process daily. Do not exceed two capsules per day.

**Warning:** Keep out of reach of children. Do not use if the safety seal is damaged or missing. Store in a cool, dry place.

**Dr.Sous.ca Probiotic 40 Billion with Prebiotics**  
Regular price: \$27.00 CAD  
Product Amount: 60 caps  
Gross Weight: 0.25lb (113g)

Probiotic 40 Billion with Prebiotics is a blend of four probiotic strains: Lactobacillus Acidophilus, Bifidobacterium Lactis, Lactobacillus Plantarum, and Lactobacillus Paracasei. Together, they provide a high level of beneficial bacteria to the gut to support a healthy metabolic response for both men and women.

**Supplement Facts**  
Serving Size: 2 Capsules  
Servings Per Container: 30

	Amount Per Serving	%DV
Probiotic Blend of Lactobacillus Acidophilus Bifidobacterium Lactis Lactobacillus Plantarum Lactobacillus Paracasei	40 Billion CFU 20 Billion CFU 20 Billion CFU 20 Billion CFU	100%
Lactobacillus Acidophilus	3.2 x 10 <sup>10</sup>	100%
Bifidobacterium Lactis	20,000,000,000	100%
Lactobacillus Plantarum	5.0 x 10 <sup>10</sup>	100%
Lactobacillus Paracasei	5.0 x 10 <sup>10</sup>	100%
Marine Polysaccharide Complex	500 mg	100%
Fructooligosaccharide	500 mg	100%

**Other Ingredients:** Cellulose, Hypromellose, Croscarmellose, Rice Maltodextrin, L-Leucine

Paradise Wellness  
A specific channel for Probiotic 40 on YouTube

Dr. Sous.ca  
www.drSous.ca

## 3. Digestive Enzymes

Gallstones are hardened deposits that form in the gallbladder and can cause severe abdominal pain, bloating, and discomfort. Digestive enzymes are naturally produced by the body to aid in the digestion and absorption of nutrients. These enzymes include lipase, protease, and amylase, which break down fats, proteins, and carbohydrates, respectively. When it comes to gallstones, digestive enzymes can help by enhancing the digestion of fats, which is particularly important since gallstones are often made up of cholesterol or bilirubin. By taking digestive enzyme supplements, individuals with gallstones may experience improved digestion and reduced symptoms. These supplements can assist in breaking down the fats that contribute to the formation of gallstones, thus potentially preventing their growth or even facilitating their dissolution.

**Ingredients:** see Supplement Facts.

**Manufacturer Country:** USA

**Product Amount:** 60 caps

**Gross Weight:** 0.25lb (133g)

**Suggested Use:** Take one (1) capsule twice a day as a dietary supplement. For best results, take 20-30 min before a meal or as directed by your healthcare professional.

**Caution:** Do not exceed recommended dose. Pregnant or nursing mothers, children under the age of 18, and individuals with a known medical condition should consult a physician before using this or any dietary supplement.

**Warning:** Keep out of reach of children. Do not use if the safety seal is damaged or missing. Store in a cool, dry place.



## 9. GALL BLADDER INFECTION (CHOLECYSTITIS)

Acute cholecystitis is swelling (inflammation) of the gallbladder. It is a potentially serious condition that usually needs to be treated in hospital. The main symptom of acute cholecystitis is a sudden sharp pain in the upper right side of your tummy (abdomen) that spreads towards your right shoulder. Acute cholecystitis is swelling (inflammation) of the gallbladder. It is a potentially serious condition that usually needs to be treated in hospital. The main symptom of acute cholecystitis is a sudden sharp pain in the upper right side of your tummy (abdomen) that spreads towards your right shoulder. The affected part of the abdomen is usually extremely tender, and breathing deeply can make the pain worse. Unlike some others types of abdominal pain, the pain associated with acute cholecystitis is usually persistent, and doesn't go away within a few hours.

### #Symptoms

- Severe pain in your upper right or center abdomen
- Pain that spreads to your right shoulder or back
- Tenderness over your abdomen when it's touched
- a high temperature (fever)
- nausea and vomiting

Some people may additional symptoms, such as:

- sweating
- loss of appetite
- yellowing of the skin and the whites of the eyes (jaundice)
- a bulge in the abdomen.

**The recommended supplements for Gall Bladder Infection (Cholecystitis) are:** Elderberry & Vitamin C, Probiotics, & Platinum Turmeric.

### 1. Elderberry & Vitamin C

Cholecystitis is a condition characterized by inflammation of the gall bladder, which can cause severe pain, nausea, and other uncomfortable symptoms. Elderberry, derived from the European elder tree, is known for its rich antioxidant content, including anthocyanins, flavonoids, and vitamin C. These compounds are believed to possess anti-inflammatory and immune-boosting properties that may aid in reducing inflammation and supporting the body's natural defense mechanisms against infection. Vitamin C, on the other hand, is a powerful antioxidant that plays a crucial role in the immune system's functioning. It helps stimulate the production of white blood cells, which are essential for fighting off infections and promoting healing. Additionally, vitamin C aids in collagen formation, which can support tissue repair and strengthen the gall bladder's lining. While these supplements may offer potential benefits, it is important

to note that they should not replace conventional medical treatment for cholecystitis.

**Ingredients:** see Supplement Facts.

**Flavor:** Elderberry

**Manufacturer Country:** USA

**Product Amount:** 60 gummies

**Gross Weight:** 0.56lb (255g)

**Suggested Use:** Take two (2) gummies once a day as a dietary supplement.

**Caution:** Do not exceed recommended dose. Pregnant or nursing women, children under 18, and individuals with known medical conditions should consult their physician before taking.

**DRSOUS.CA Elderberry & Vitamin C Gummies**

Regular price: \$25.00 CAD  
Product Amount: 60 gummies  
Gross Weight: 0.56lb (255g)

Packed with immune-boosting nutrients, including Vitamin C, Zinc, and Elderberry, this gummy is a popular way to receive antioxidants and boost overall health.

- Immune boosting
- Overall health
- Eases cold and flu symptoms
- Improves iron absorption

**Supplement Facts**

	Amount Per Serving	% Daily Value
Total Gummies	60	100%
Vitamin C (Ascorbic Acid)	1000 mg	2000%
Zinc (Zinc Oxide)	15 mg	300%
Elderberry (Elderberry Extract)	100 mg	100%
Other Ingredients: Glycerin, Citric Acid, Natural Flavors, and Vitamin E.		

Paradise Wellness A specific channel for Elderberry & Vitamin C on YouTube

Dr. Sous www.drsous.ca

## 2. Platinum Turmeric

Cholecystitis is a painful condition characterized by inflammation of the gallbladder, often caused by gallstones obstructing the flow of bile. This condition can result in severe abdominal pain, nausea, vomiting, and fever. Traditional treatment options range from antibiotics to surgical removal of the gallbladder. However, there is growing interest in exploring natural remedies like Platinum Turmeric supplements as an alternative or complementary approach. Turmeric, a vibrant yellow spice commonly used in Indian cuisine, contains a compound called curcumin, which is believed to possess powerful anti-inflammatory and antioxidant properties. These properties are thought to help alleviate inflammation and reduce oxidative stress within the gallbladder, potentially improving the symptoms associated with cholecystitis. Additionally, curcumin has been shown to exhibit antimicrobial properties, which might aid in combating the infection causing cholecystitis. Platinum Turmeric supplements offer a convenient and standardized way to incorporate curcumin into one's daily routine. These supplements are carefully formulated to contain a higher concentration of curcumin than what is typically found in turmeric powder alone. This ensures that individuals can obtain a therapeutic dose of curcumin without having to consume large amounts of turmeric in their diet.

**Ingredients:** see Supplement Facts.

**Manufacturer Country:** USA

**Product Amount:** 60 caps

**Gross Weight:** 0.25lb (113g)

**Suggested Use:** Take two (2) capsules once a day as a dietary supplement. For best results, take 20-30 min before a meal or as directed by your healthcare professional.

**DrSous.Ca Platinum Turmeric 60 Capsule Bottle**

Regular price: \$20.00 CAD  
Product Amount: 60 caps  
Gross Weight: 0.25lb (113g)

Our Platinum Turmeric blend contains various forms of turmeric, glucosamine, Boswellia extract (frankincense), piperine, and several other highly beneficial natural extracts to keep you at your best.

- Anti-inflammatory
- Joint and bone health
- Heart Protective
- Anti-oxidant & Anti-Cancer

**Supplement Facts**

	Amount Per Serving	% Daily Value
Platinum Turmeric Blend	600 mg	100%
Glucosamine HCl	500 mg	100%
Boswellia Extract (Frankincense)	100 mg	100%
Piperine	50 mg	100%
Other Ingredients: Glycerin, Citric Acid, Natural Flavors, and Vitamin E.		

Paradise Wellness A specific channel for Platinum Turmeric on YouTube

Dr. Sous www.drsous.ca



## CHAPTER V. PROSTATE & TESTOSTERONE CONDITIONS

### What is testosterone?

Testosterone is the male sex hormone that is made in the testicles. Testosterone hormone levels are important to normal male sexual development and functions.

During puberty (in the teen years), testosterone helps boys develop male features like body and facial hair, deeper voice, and muscle strength. Men need testosterone to make sperm.

Testosterone plays multiple important roles in the body, such as:

- development of the penis and testes
- deepening of the voice during puberty
- Bone density
- Fat distribution
- Muscle strength and mass
- Facial and body hair
- Red blood cell production
- Sex drive
- Sperm production

Testosterone levels generally peak during adolescence and early adulthood. As you age, your testosterone level gradually declines typically about 1% a year after age 30 or 40. For older men, it's important to determine if a low testosterone level is due to normal aging or if it is due to a disease (hypogonadism).

Hypogonadism hampers the ability to produce normal amounts of testosterone due to a problem with the testicles or with the pituitary gland that controls the testicles.

### 1) LOW TESTOSTERONE LEVELS/ HYPOGONADISM

Low testosterone levels, also known as hypogonadism, can have a significant impact on both physical and mental well-being. Testosterone is a hormone that plays a crucial role in the development and maintenance of male characteristics, such as muscle mass, bone density, and libido. When testosterone levels are low, it can lead to a variety of symptoms, including decreased energy levels, reduced muscle strength, increased body fat, and even erectile dysfunction. Additionally, low testosterone can also affect mood and cognitive function, leading to feelings of depression, irritability, and difficulty concentrating. It is important to note that low testosterone levels can occur in men of all ages, although it is more common in older individuals. There are several factors that can contribute to low testosterone, including aging, certain medical conditions (such as diabetes or obesity), and certain medications. If you suspect that you may have low testosterone, it is recommended to consult with a healthcare professional who can evaluate your symptoms and perform appropriate tests. Treatment options for low testosterone may include lifestyle changes, such as exercise and weight management, as well as hormone replacement therapy if necessary. With proper diagnosis and treatment, individuals with low testosterone can experience improvements in their overall health and quality of life.

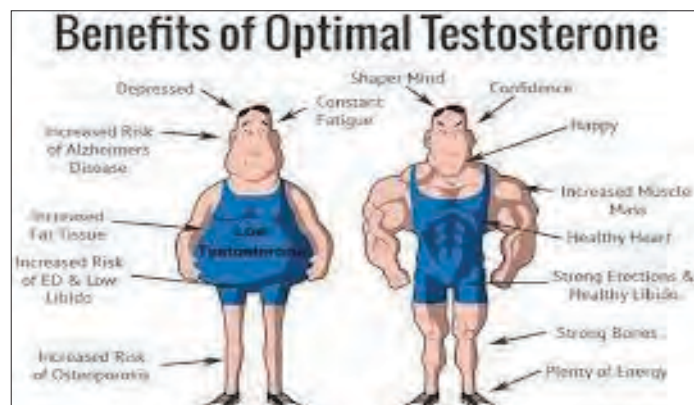





regularly, men can experience an increase in energy levels, improved muscle mass, enhanced libido, and an overall improvement in their sense of well-being. Additionally, these supplements also contain key vitamins and minerals that are essential for maintaining optimal health. These include vitamin D, zinc, magnesium, and vitamin B6, which all play a crucial role in supporting testosterone production and overall male health.



### 3. Ashwagandha

Ashwagandha, a herb commonly used in traditional Ayurvedic medicine, has been studied for its potential to naturally increase testosterone levels. Research suggests that Ashwagandha may stimulate the production of luteinizing hormone, which in turn promotes the production of testosterone. Additionally, Ashwagandha has been shown to reduce cortisol levels, a stress hormone that can inhibit testosterone production. By reducing stress and promoting hormonal balance, Ashwagandha supplements may help optimize testosterone production. However, it is important to note that while some studies suggest a positive correlation between Ashwagandha supplementation and increased testosterone levels, more research is needed to fully understand the extent and mechanisms of its effects. As with any supplement, it is advisable to consult with a healthcare professional before starting Ashwagandha supplementation, especially for individuals with pre-existing medical conditions or who are taking other medications. Additionally, it is crucial to understand that a healthy lifestyle, including regular exercise, a balanced diet, and adequate sleep, is essential for maintaining optimal testosterone levels.

**Ingredients:** see Supplement facts.

**Manufacturer Country:** USA

**Amount:** 60 caps

**Gross Weight:** 0.25lb (113g)

**Suggested Use:** Take two (2) capsules once a day as a dietary supplement. For best results, take 20-30 min before a meal with an 8oz glass of water or as directed by your healthcare professional.

**Caution:** Do not exceed recommended dose. Pregnant or nursing mothers, children under the age of 18, and individuals with a known medical condition should consult a physician before using this or any dietary supplement.



## 2) ENLARGED PROSTATE

The prostate is a gland that produces some of the fluid that carries sperm during ejaculation. The prostate gland surrounds the urethra, the tube through which urine passes out of the body. An enlarged prostate means the gland has grown bigger. Prostate enlargement happens to almost all men as they get older. An enlarged prostate is often called benign prostatic hyperplasia (BPH). It is not cancer, and it does not raise your risk for prostate cancer.

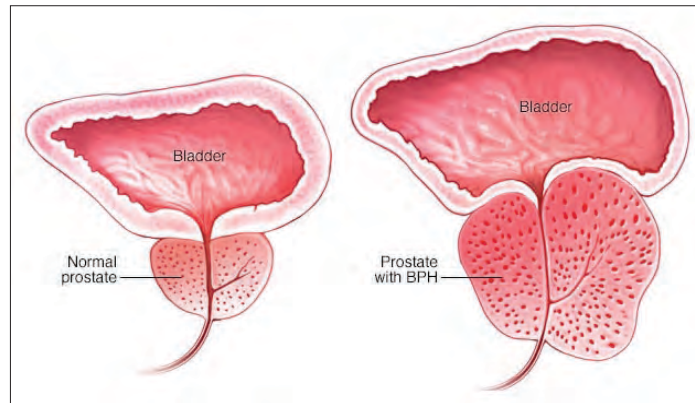

As the prostate gland grows bigger, it can pinch the urethra, which runs through its center. When this happens, the flow of urine becomes slower and less forceful. Also, the bladder walls grow thicker as men age. In some cases, benign prostate enlargement can lead to urinary tract, bladder, or kidney problems.

### Causes

The actual cause of prostate enlargement is unknown. Factors linked to aging and changes in the cells of the testicles may have a role in the growth of the gland, as well as testosterone levels. It might also be due to changes in the balance of sex hormones as you grow older. Men who have had their testicles removed at a young age (for example, as a result of testicular cancer) do not develop BPH.

### # Symptoms

#### 1. Frequent Urge to Urinate

BPH increases the urge to urinate; urinary retention is the most significant symptom of an enlarged prostate gland. As well as being inconvenient, this can be uncomfortable and makes many activities of daily living difficult. One of the treatments available for urinary retention is bladder decompression, a procedure that involves inserting a catheter into the bladder to drain it. In very rare cases where bladder decompression doesn't work, you may need surgery to relieve it.

#### 2. Urinary Tract Infections

Urinary tract infections (UTI) are a less common symptom of BPH. Sometimes, the enlarged prostate can block the flow of urine from the bladder, preventing it from emptying completely. This gives bacteria the opportunity to develop in excess and lead to infection. The treatment for a UTI is usually a course of antibiotics, but if the UTI is secondary to the BPH, your doctor will treat the primary condition first.

#### 3. Increased Urination during the Night

Waking up many times during the night because you have to urinate is known as nocturia, a common urological condition that can arise as a result of an enlarged prostate. Frequent urination during the night interrupts sleep, leaving you tired during the day. People with a tendency to get nocturia, whether from BPH or another cause, can cut back on diuretics such as alcohol and caffeine, particularly in the hours before bed. Such beverages make the body produce more urine and can exacerbate the issue.

#### 4. Weak Urine Flow

An enlarged prostate is the most common cause of weak urine flow in men over the age of 45. Urinary hesitancy happens because the



## 2. Platinum Turmeric

Platinum Turmeric blend is a unique combination of turmeric, glucosamine, Boswellia extract (frankincense), and piperine. Enlarged prostate, also known as benign prostatic hyperplasia (BPH), is a common condition that affects many men, especially as they age. This blend of natural ingredients offers a holistic approach to managing the symptoms associated with an enlarged prostate. Turmeric, a powerful antioxidant and anti-inflammatory herb, has been used for centuries in traditional medicine for its numerous health benefits. Its active compound, curcumin, has been shown to reduce inflammation and alleviate the symptoms of BPH. By including glucosamine in the blend, Platinum Turmeric not only supports prostate health but also promotes overall joint health. Boswellia extract, commonly known as frankincense, is derived from the resin of the Boswellia serrata tree. It possesses anti-inflammatory properties and has been traditionally used to relieve pain and reduce swelling. When combined with turmeric and glucosamine, Boswellia extract enhances the blend's effectiveness in managing the symptoms of an enlarged prostate. Lastly, piperine, a natural compound found in black pepper, is added to the blend to enhance the absorption of curcumin and other active ingredients, ensuring maximum bioavailability and efficacy. With its carefully selected ingredients, Platinum Turmeric offers a natural and effective solution for individuals seeking relief from the discomforts of an enlarged prostate, promoting prostate health and overall well-being.

**Ingredients:** see Supplement Facts.

**Manufacturer Country:** USA

**Product Amount:** 60 caps

**Gross Weight:** 0.25lb (113g)

**Suggested Use:** Take two (2) capsules once a day as a dietary supplement. For best results, take 20-30 min before a meal or as directed by your healthcare professional.

**DrSous.ca Platinum Turmeric 60 Capsule Bottle**  
Regular price: \$20.00 CAD  
Product Amount: 60 caps  
Gross Weight: 0.25lb (113g)  
Our Platinum Turmeric blend contains various forms of turmeric, glucosamine, Boswellia extract (frankincense), piperine, and several other highly beneficial natural extracts to keep you at your best.

- Anti-inflammatory
- Joint and bone health
- Heart Protective
- Anti-oxidant & Anti- Cancer

**Supplement Facts**  
Serving Size: 2 Capsules  
Amount Per Serving %DV

Amount Per Serving	%DV
Glucosamine HCL (Type II)	100%
Curcumin (Type I)	100%
Boswellia Extract (Type I)	100%
Piperine (Type I)	100%
Black Pepper Extract (Type I)	100%
Garlic Extract (Type I)	100%
Green Tea Extract (Type I)	100%
Resveratrol (Type I)	100%
Omega-3 Fatty Acids (Type I)	100%
Chondroitin Sulfate (Type I)	100%
MSM (Type I)	100%
Collagen (Type I)	100%
Hydrolyzed Collagen (Type I)	100%
Other Ingredients: Cellulose, Hydroxypropyl Methylcellulose, Croscarmellose, Magnesium Stearate, Polyethylene Glycol, and Titanium Dioxide.	

**Other Ingredients:** Cellulose, Hydroxypropyl Methylcellulose, Croscarmellose, Magnesium Stearate, Polyethylene Glycol, and Titanium Dioxide.

**Contains:** Shellfish (Crab, Lobster and Shrimp)

Paradise Wellness  
A specific channel for Platinum Turmeric on YouTube

Dr. Sous | www.drsous.ca

## 3. Vitamin D3

Studies have suggested that low levels of vitamin D3 may be associated with an increased risk of developing BPH. Vitamin D3, also known as cholecalciferol, is synthesized in the skin through exposure to sunlight and can also be obtained from certain dietary sources. It plays a crucial role in maintaining bone health, regulating the immune system, and supporting overall well-being. Additionally, emerging evidence suggests that vitamin D3 may possess anti-inflammatory and anti-proliferative properties, which could potentially benefit individuals with BPH. Some studies have found a correlation between low vitamin D3 levels and more severe urinary symptoms in men with BPH.

**Ingredients:** see Supplement Facts.

**Manufacturer Country:** USA

**Product Amount:** 100 soft-gels

**Gross Weight:** 0.1lb (45g)

**Suggested Use:** As a dietary supplement, adults take one (1) soft-gel capsule daily or as directed by a health care professional. Store in a cool, dry place and away from direct light.

**Warning:** Keep out of reach of children. Do not use if the safety seal is damaged or missing. Store in a cool, dry place.

### 3) PROSTATE CANCER

The word “prostate” originated from Ancient Greek meaning “one who stands before”, “guardian”, or “protector”. It is a gland found in the male reproductive system and functions to secrete a milky white slightly alkaline fluid that constitutes approximately 30% of the semen. The alkalinity is important as it helps to neutralize the acidity of the vagina and therefore, increases the lifespan of the sperm for fertilization. Prostate cancer occurs when cancer occurs in the small walnut shaped gland. It is one of the commonest types of cancer in men. Since most prostate cancer has a slow growth, it is usually initially confined to the prostate without causing invasion or spread. However, there are also other types that can be aggressive and spread quickly.

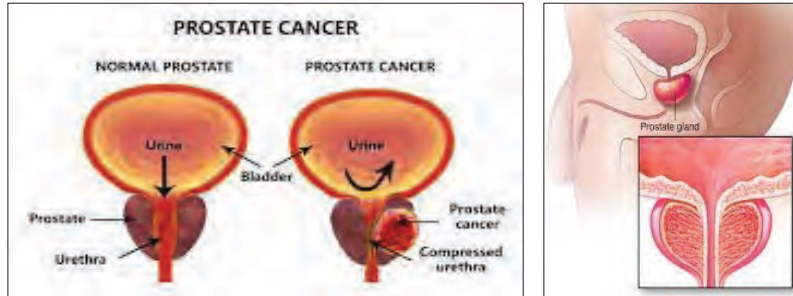

Risk factors include advancing age, positive family history, and race. Other factors that may be involved are having a diet high in red meat, processed meat, milk products and low in vegetables. The diagnosis of prostate cancer is achieved through biopsy and medical imaging is utilized to assess the spread and invasion of the cancer to other parts of the body. Prostate specific antigen is a tumor marker that can increase the detection of prostate cancer, but the improvement of prognosis is controversial. Treatment and management includes watchful waiting, or a combination of surgery, radiotherapy, chemotherapy, or hormone therapy. Medications prescribed depend on the severity and spread of the disease.

#### # Symptoms

##### #1: Difficulty Urinating

Patients with prostate cancer may have difficulty urinating as they often feel the urge to urinate but sometimes there may be little to no urine. It may also stop midstream. Increased frequency (having the need to go to the bathroom more often) is also another sign. There may be difficulty stopping the pee leading to extended dribbling and sometimes the sensation that you still need to pee even after you have just visited the bathroom. Since the prostate gland anatomically surrounds the urethra, even a small growth can cause issues with urination and ejaculation. However, the enlargement of the prostate gland is common in men as they age, a condition known as benign prostatic hyperplasia which can also cause urinating difficulties. It is important to distinguish between the two conditions.

## **#2: Decreased Urine Stream**

As men grow older, their urine stream starts getting less potent over time. This symptom is often associated with Benign Prostatic Hyperplasia (BPH), but it can also be seen in patients with prostate cancer. It is important for patients to seek medical attention for proper diagnosis.

## **#3: Hematuria**

Hematuria is a term that describes the presence of blood in the urine where it can be gross (seen with the naked eye) or microscopic (only seen under a microscope). In prostate cancer patients, this is a less common sign but if present, should warrant an immediate visit to your doctor. Keep an eye out as all you notice might only be a slightly pinkish tint in your urine. Besides prostate cancer, there are many causes of hematuria such as infections in the prostate, bladder, kidney stones, benign prostatic hyperplasia, and other tumors in the bladder or kidneys. Some foods can also turn the urine pinkish but blood is not present.

## **#4: Blood in the Semen**

As previously established, the prostate gland produces a milky white alkaline fluid that makes up about 30% of the semen. Therefore, in prostate cancer, blood may be seen in the semen. Just like hematuria, there is not a large amount of blood. Instead, the semen will look pinkish or have streaks. Both the affected individual and their partner should speak up about it if they notice pinkish or blood streaks in the semen. Ensure that you seek medical attention.

## **#5: Difficulty with an Erection**

While many men may find it hard to admit, any difficulty getting or maintaining an erection is a serious issue that should warrant a visit to the doctor as it may be a symptom of prostate cancer. If you notice that your partner is having issues with an erection, empathize and tread delicately around the subject to coax your partner to see a doctor as he will be reluctant.

Issues with erection are not only a symptom of prostate cancer but can be also caused by atherosclerosis (buildup of plaque along the arteries) which leads to diminished blood flow to the penis. However, prostate cancer interferes with both erections and ejaculations.

**The recommended supplements which can help in patients with prostate cancer in remission are:** Resveratrol, Platinum Turmeric, & Vitamin D3.

### **1. Resveratrol**

Resveratrol, a natural polyphenol compound found in various plants, has gained significant attention in the field of cancer research, particularly in relation to prostate cancer. Numerous studies have suggested that resveratrol possesses remarkable potential as a therapeutic agent for this prevalent form of cancer. One of the key mechanisms by which resveratrol exerts its anticancer effects is through its ability to inhibit the growth and proliferation of prostate cancer cells. It has been shown to induce cell cycle arrest, leading to a halt in the progression of cancer cells. Additionally, resveratrol has been found to trigger apoptosis, a process of programmed cell death, in prostate cancer cells, thereby preventing their uncontrolled growth and spread. Moreover, resveratrol exhibits potent anti-inflammatory properties, which are crucial in the context of prostate cancer, as inflammation is closely linked to the development and progression of this disease. By suppressing the production of inflammatory molecules, resveratrol helps create an unfavorable environment for cancer cells to thrive. Furthermore, resveratrol has been shown to inhibit angiogenesis, the formation of new blood vessels that supply nutrients to tumors, thus starving prostate cancer cells of their vital oxygen and nutrients. Additionally, resveratrol possesses antioxidant properties, enabling it to neutralize harmful free radicals and protect cells from oxidative stress, a key contributor to cancer development.

**Ingredients:** see Supplement Facts.

**Manufacturer Country:** USA

**Product Amount:** 60 caps

**Gross Weight:** 0.25lb (113g)

**Suggested Use:** Take one (1) veggie capsule twice a day as a dietary supplement. For best results, take 20-30 min before a meal or as directed by your healthcare professional.

**Caution:** Do not exceed recommended dose. Pregnant or nursing mothers, children under the age of 18, and individuals with a known medical condition should consult a physician before using this or any dietary supplement.

**Warning:** This product is not intended to diagnose, treat, cure or prevent any disease. Keep out of reach of children. Do not use if the safety seal is damaged or missing. Store in a cool, dry place.



## 2. Platinum Turmeric

Our Platinum Turmeric blend is a meticulously crafted combination of turmeric, bromelain, Boswellia extract (frankincense), piperine and much more. Turmeric, a golden spice widely known for its medicinal properties, contains a powerful compound called curcumin. Curcumin has been extensively studied for its potential anti-cancer effects, including inhibiting the growth of prostate cancer cells and suppressing tumor development. Bromelain, derived from pineapples, is a natural enzyme that possesses anti-inflammatory and anti-cancer properties. It has been shown to inhibit the growth of cancer cells and enhance the immune system's response to cancer. Boswellia extract, commonly known as frankincense, has been used for centuries in traditional medicine for its anti-inflammatory and anti-cancer properties. Studies have shown that Boswellia extract can induce apoptosis (programmed cell death) in prostate cancer cells and inhibit tumor growth. Piperine, derived from black pepper, is a bioactive compound that enhances the bioavailability of curcumin and other nutrients. It helps to improve the absorption and effectiveness of the other ingredients in our Platinum Turmeric blend. Together, these powerful ingredients work synergistically to provide a comprehensive approach to combating prostate cancer. Our Platinum Turmeric blend is crafted with the utmost care and quality to ensure the highest potency and effectiveness. It is a natural and safe alternative or complementary therapy for individuals looking to support their prostate health and fight against prostate cancer.

**Ingredients:** see Supplement Facts.

**Manufacturer Country:** USA

**Product Amount:** 60 caps

**Gross Weight:** 0.25lb (113g)

**Suggested Use:** Take two (2) capsules once a day as a dietary supplement. For best results, take 20-30 min before a meal or as directed by your healthcare professional.

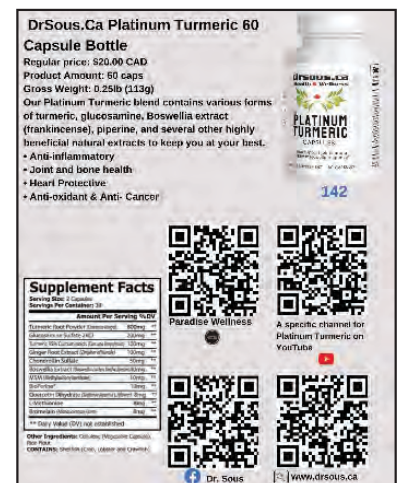



### 3. Vitamin D3

Vitamin D3, also known as cholecalciferol, is synthesized in the skin upon exposure to sunlight and can also be obtained from certain foods and supplements. It plays a crucial role in maintaining bone health and regulating calcium levels in the body. However, emerging evidence suggests that vitamin D3 may also possess anti-cancer properties, particularly in relation to prostate cancer. Studies have shown that adequate levels of vitamin D3 are associated with a lower risk of developing prostate cancer, as well as improved outcomes in patients already diagnosed with the disease. Vitamin D3 exerts its effects through various mechanisms, including inhibition of cell proliferation, induction of cell death, and modulation of the immune system. Moreover, vitamin D3 has been shown to interact with several signaling pathways involved in prostate cancer development and progression. These findings have led to increased interest in the use of vitamin D3 supplementation as an adjuvant therapy for prostate cancer. However, more research is needed to determine the optimal dosage, duration, and safety profile of vitamin D3 supplementation in prostate cancer patients.

**Ingredients:** see Supplement Facts.

**Manufacturer Country:** USA

**Product Amount:** 100 soft-gels

**Gross Weight:** 0.1lb (45g)

**Suggested Use:** As a dietary supplement, adults take one (1) soft-gel capsule daily or as directed by a health care professional. Store in a cool, dry place and away from direct light.

**Warning:** Keep out of reach of children. Do not use if the safety seal is damaged or missing. Store in a cool, dry place.

### 4) FASTER ERECTION/ PREMATURE EJACULATION

#### What Is an Erection?

An erection is when the penis becomes engorged with blood and ready for sexual activity. When a man is not sexually aroused, his penis is soft or flaccid. The muscles around the arteries in his penis are tight, limiting blood flow into the sponge-like erectile tissue (called corpus cavernosa) that makes up most of the organ. During the arousal process, when a man becomes sexually stimulated, his brain sends signals through his nervous system to the muscles around the arteries in his penis, telling them to relax, widen, and allow more blood to fill the corpus cavernosa. When more blood rushes in, it creates pressure in the penis, engorging and stiffening it for sexual activity.

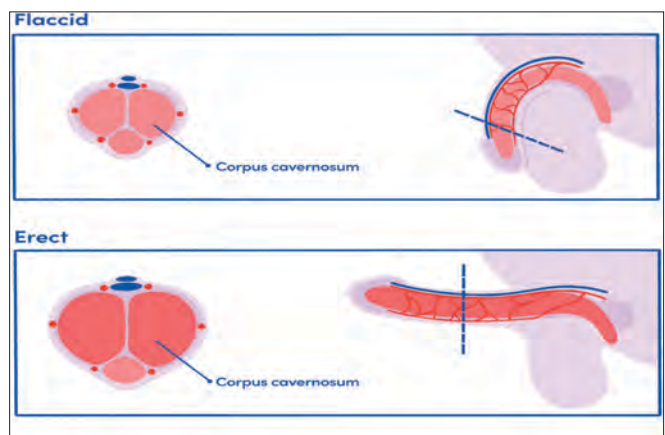

### What is premature ejaculation?

Premature ejaculation is a type of sexual dysfunction that occurs when a man has an orgasm and releases (ejaculates) semen sooner than he or his partner would like. It often happens before or shortly after penetration during intercourse.

### What causes premature ejaculation?

Physical, chemical and emotional/psychological factors cause premature ejaculation.

#### Physical and chemical problems include:

- An underlying erectile dysfunction diagnosis.
- A hormonal problem with oxytocin levels, which has a role in sexual function in men. Other hormone levels that play a role in sexual function include luteinizing hormone (LH), prolactin and thyroid stimulating hormone (TSH)
- Low serotonin or dopamine levels, chemicals in the brain that are involved in sexual desire and excitement.
- A penis that is extra sensitive to stimulation.

#### Emotional or psychological causes include:

- Performance anxiety. Could be due to the nervousness of being with a new partner, anxiousness of having sex again after a long period of abstinence, lack of confidence, guilt, being overly excited or stimulated or other reasons.
- Stress.
- Relationship problems.
- Depression
- Early sexual experiences
- Sexual abuse
- Poor body image

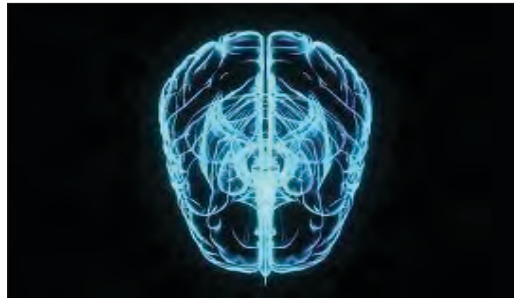

### # Symptoms

The main symptom of premature ejaculation is not being able to delay ejaculation for more than three minutes after penetration. But it might occur in all sexual situations, even during masturbation.

#### Premature ejaculation can be classified as:

**Lifelong.** Lifelong premature ejaculation occurs all or nearly all the time beginning with the first sexual encounter.

**Acquired.** Acquired premature ejaculation develops after having previous sexual experiences without problems with ejaculation.

Many people feel that they have symptoms of premature ejaculation, but the symptoms don't meet the criteria for a diagnosis. It's typical to experience early ejaculation at times.

**The most recommended supplements to boost your testosterone levels or to avoid premature ejaculations are:** Testosterone Booster, Ashwagandha, & Ginkgo Biloba + Ginseng.

## 1. Testosterone Booster

Testosterone is a hormone that plays a crucial role in various bodily functions, including muscle growth, bone density, libido, male sexual characteristics and plays a crucial role in sexual function. This supplement typically contains a combination of natural ingredients such as herbs like Tribulus Terrestris, horny goat weed, longjack, saw palmetto berries, and vital minerals like magnesium and zinc that are believed to enhance testosterone levels. It is believed that a deficiency in testosterone levels may contribute to premature ejaculation. Testosterone booster supplements are designed to increase testosterone levels, potentially improving sexual performance and addressing premature ejaculation.

Balancing testosterone levels in the body provides numerous health benefits, such as increased strength, libido, and immune response.

**Ingredients:** see Supplement Facts.

**Manufacturer Country:** USA

**Product Amount:** 90 caps

**Gross Weight:** 0.14lb (65g)

**Suggested Use:** Take three (3) capsules before bedtime.

**Warning:** Consult with a physician before use if you have any medical conditions. Do not use if pregnant or lactating.

**DrSous.Ca Testosterone Booster**  
Regular price \$33.00 CAD  
Product Amount: 90 caps  
Gross Weight: 0.14lb (65g)

Testosterone is a hormone in the body that is responsible for muscle growth and maintenance. Balancing testosterone levels in the body provides numerous health benefits, such as increased strength, libido, and immune response. Testosterone Booster gives you an edge in your workouts by increasing strength and decreasing recovery time.

**Supplement Facts**

	Amount Per Serving	% Daily Value
Serving Size: 3 Capsules		(Amounts are based on a diet of other people's secrets)
Regulation of Magnesium (Mg)	200 mg	40%
Zinc (Zn)	50 mg	22%
Tribulus Terrestris (TT)	100 mg	
Organic Horny Goat Weed	10 mg	
Horny Goat Weed	50 mg	
Longjack (Eurycoma longifolia)	80 mg	
Saw Palmetto Berries	50 mg	
Cholesterol Support	50 mg	
Cholesterol Support (Large Dose)	50 mg	
Cholesterol Support (Small Dose)	50 mg	

† Daily Value (DV) not established.

†† Other Ingredients: Cellulose, Magnesium Stearate, Hydroxypropyl Methylcellulose, Croscarmellose, Hydroxypropyl Methylcellulose, Croscarmellose, Hydroxypropyl Methylcellulose, Croscarmellose.

Dr. Sous | www.drsous.ca

## 2. Ashwagandha

Ashwagandha, a powerful herb used in traditional Ayurvedic medicine, has gained popularity in recent years for its potential to boost testosterone levels. Testosterone, a hormone primarily associated with male sexual health and muscle development, plays a crucial role in overall well-being for both men and women. Ashwagandha, scientifically known as *Withania somnifera*, has been shown to have adaptogenic properties, meaning it helps the body manage stress and maintain balance. Research suggests that Ashwagandha may have a positive impact on testosterone levels by reducing cortisol, a stress hormone that can inhibit testosterone production. Additionally, Ashwagandha contains compounds called withanolides, which have been found to stimulate the release of luteinizing hormone (LH), a key hormone involved in testosterone production. By regulating stress levels and promoting hormonal balance, Ashwagandha may offer a natural and holistic approach to boosting testosterone levels.

**Ingredients:** see Supplement facts.

**Manufacturer Country:** USA

**Amount:** 60 caps

**Gross Weight:** 0.25lb (113g)

**Suggested Use:** Take two (2) capsules once a day as a dietary supplement. For best results, take 20-30 min before a meal with an 8oz glass of water or as directed by your healthcare professional.

**Caution:** Do not exceed recommended dose. Pregnant or nursing mothers, children under the age of 18, and individuals with a known

medical condition should consult a physician before using this or any dietary supplement.

**Warning:** This product is not intended to diagnose, treat, cure or prevent any disease. Keep out of reach of children. Do not use if the safety seal is damaged or missing. Store in a cool, dry place.

**DRSOUS.CA Ashwagandha to help individuals calm stress hormones**  
Regular price: \$28.00 CAD  
Amount: 60 capsules  
Gross Weight: 0.25lb (113g)  
Ashwagandha is an ancient herb used in Ayurvedic medicine of India. Many bioactive substances, including alkaloids, flavonoids, glycosides, steroids, and steroidal lactones, are present in ashwagandha.

- To reduce anxiety (strong feelings of worry) & stress
- To reduce joint pain
- To help with diabetes

Supplement Facts	
Serving Size: 2 Capsules Servings Per Container: 30	
	Amount Per % Daily Serving Value
Organic Ashwagandha (Withania somnifera)(root)	1300mg
Organic Black Pepper (Piper nigrum)(fruit)	10mg

\*\*Daily Value not established.  
Inactive Ingredients: Pullulan capsules.

QR codes for: Paradise Wellness, Dr. Sous, www.drsoous.ca

### 3. Ginkgo Biloba + Ginseng

Ginkgo Biloba is a plant originating in Asia that was used in ancient Chinese medicine. Usually, the herb's leaves are used, but the seeds are shown to have the highest efficacy. Ginkgo contains numerous flavonoids and terpenoids, which promote blood flow in the body and brain. Ginkgo Biloba and Ginseng have long been recognized for their potential health benefits, and when combined as a supplement, they may offer a natural way to boost testosterone levels. Ginkgo Biloba, known for its cognitive-enhancing properties, has also shown potential in increasing testosterone levels. This ancient herb is believed to improve blood circulation, which is essential for the delivery of hormones throughout the body. By enhancing blood flow, Ginkgo Biloba may help optimize testosterone production and support healthy levels. On the other hand, Ginseng, a popular adaptogen, has been traditionally used to promote vitality and improve sexual function. Several studies have suggested that Ginseng may stimulate testosterone production by influencing the hypothalamic-pituitary-gonadal axis, a key regulatory system for hormone production in the body. Moreover, both Ginkgo Biloba and Ginseng possess antioxidant properties that can protect the body against oxidative stress, which may contribute to a decline in testosterone levels. In combination with Ginkgo, Ginseng plays a vital role in boosting the body's immune system - helping to combat cold and flu symptoms. Ginseng also provides energy to the body through compounds known as ginsenosides.

**Ingredients:** See Supplement Facts.

**Manufacturer Country:** USA

**Product Amount:** 60 caps

**Gross Weight:** 0.25lb (133g)

**Suggested Use:** As a dietary supplement, take two (2) capsules before bedtime or as directed by your healthcare professional.

**Warning:** Keep out of reach of children. Do not use if the safety seal is damaged or missing. Store in a cool, dry place.

The Food and Drug Administration has not evaluated these statements. This product is not intended to diagnose, treat, cure or prevent any disease.

**DrSous.Ca Ginkgo Biloba + Ginseng**  
Regular price: \$28.00 CAD  
Product Amount: 60 caps  
Gross Weight: 0.25lb (133g)  
Ginkgo Biloba is a herb used in ancient Chinese medicine for its effective antioxidant properties. Ginkgo Biloba is one of the oldest and most-commonly-used brain supplement for better mental function. Combine it with Ginseng for benefits to blood flow, oxygen, nutrient absorption in the brain & to strengthen the immune system.

- Anti-aging
- Helps to combat cold and flu symptoms.
- Improved memory and cognition
- Strong antioxidant

Supplement Facts	
Serving Size: 2 Capsules Servings Per Container: 30	
	Amount Per Serving % DV
Red Panax Ginseng Extract (Standardized to 7% Ginsenosides)(leaf)	500mg
Ginkgo Biloba Leaf Powder	500mg
Ginkgo Biloba Leaf 24% Flavone	120mg

\*\*Daily Value (DV) not established.  
Other Ingredients: Vegetable Cellulose, Proprietary Stearic Acid, Pullulan, Dicalcium Phosphate.

QR codes for: Paradise Wellness, Dr. Sous, www.drsoous.ca

## 5) PROSTATITIS (INFLAMMATION)

Prostatitis is a condition that's most notably marked by an inflammation of the prostate gland. There are a number of things that can contribute to prostatitis, such as infections or other health issues. The problem is quite common, with almost 2 million Americans seeking help for the issue on a yearly basis. About 10% of all men experience prostatitis at some point during their lives. Depending on the cause and the patient's lifestyle, prostatitis can either be acute, chronic, or recurring. There are several different classifications as a result.

**Acute bacterial prostatitis** is caused by a bacterial infection. The patient will demonstrate urinary tract infection symptoms and perhaps other general symptoms that are typical of an infection. Acute bacterial prostatitis is the least common variety. Chronic bacterial prostatitis is similar to the previous kind but occurs several times. Symptoms often disappear between flareups. Unfortunately, this particular type of the condition can be difficult to treat.

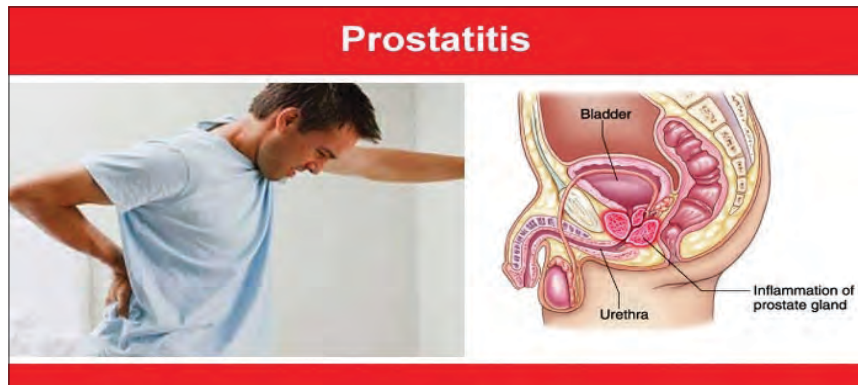

**Chronic prostatitis** is a recurring condition that is not caused by bacteria. It may or may not be related to inflammation; otherwise, no particular cause has been identified by the medical community. Symptoms tend to wax and wane depending on the patient's health and other factors. The fourth and final type of prostatitis is known as asymptomatic inflammatory prostatitis. This condition doesn't lead to any symptoms and is usually only identified when a patient is getting a checkup for infertility or cancer.

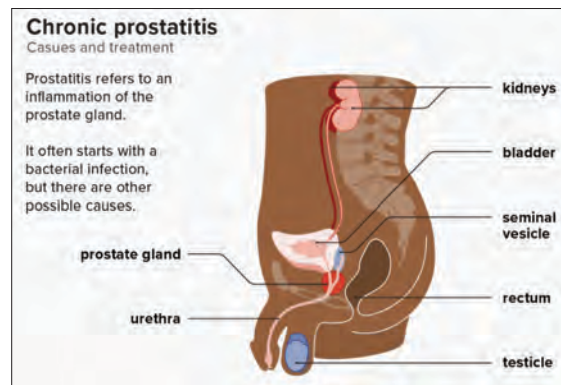

### # Symptoms

#### #1: Painful Urination

One of the most common symptoms associated with prostatitis is painful urination. While there are many conditions and problems that can lead to someone experiencing painful urination, in most cases it's important to get a checkup with your healthcare provider to ensure that you're not struggling with a problem that could get worse.

#### #2: Blood in the Urine

Many men experiencing prostatitis report that they see blood in their urine. The blood may come out in various shades of red. Some people observe blood in their urine to be a shade of brown or simply as dark urine.

If you experience blood in your urine then this is a sure sign that you should get checked up by your healthcare provider. They will

help you determine the problem and help you find a solution.

### **#3: Groin Pain**

The groin is a part of your hip that's located between your stomach and your thigh. The groin is the area where your abdomen stops and your legs begin. In the groin, there are several muscles involved in the movement of your legs. Patients with prostatitis often report that they experience pain in the groin area. Pain can also be experienced in the testicles, the penis, above the pubic bone, the area between the testicles and anus, among others. This pain can come as a slow throbbing or a sharp pain and often persists. If you are experiencing pain the best course of action is to see your medical provider so you can seek a long-term solution.

### **#4: Nausea**

Earlier, we mentioned that prostatitis can be the result of a bacterial infection and cause flu-like symptoms. One of the symptoms most commonly associated with the flu is nausea, a queasy-sick feeling that may or may not precede vomiting. Nausea is an indication that your body is processing something that it believes does not belong inside. In this case, the invader is bacteria that is causing inflammation of the prostate. Not everyone with prostatitis will experience vomiting in addition to their nausea, but some may. Over-the-counter or herbal antiemetics are usually enough to manage the nausea caused by prostatitis.

### **#5: Rectal Pain**

The rectum is the area in your large intestine where feces are held before they are passed out of the body. The prostate itself is also located in this region, so it's natural that you may experience some pain in the rectum and the surrounding area if you're struggling with prostatitis.

In many cases, doctors may recommend small doses of over-the-counter anti-inflammatory drugs which can help to soothe this discomfort. Unfortunately, these drugs are known for being harsh on the digestive system and should be used in moderation. It is best to speak with your doctor about the best ways to control your pain.

## **1. Testosterone Booster**

Prostatitis, a condition characterized by inflammation of the prostate gland, can cause discomfort and urinary symptoms in men. In the quest for natural remedies, several herbal supplements have gained attention for their potential benefits in managing prostatitis symptoms. Our testosterone booster is a combination of natural ingredients such as herbs like Tribulus Terrestris, horny goat weed, long jack, saw palmetto berries, and vital minerals like magnesium and zinc. Tribulus Terrestris, a plant commonly used in traditional medicine, has been studied for its anti-inflammatory and antioxidant properties. It may help alleviate symptoms such as pain and urinary difficulties associated with prostatitis. Saw palmetto berries, derived from the *Serenoa repens* plant, have long been used to support prostate health. Research suggests that saw palmetto may help reduce inflammation and improve urinary symptoms in men with prostatitis. Zinc and magnesium, essential minerals for overall health, have also been linked to prostate function. Zinc plays a crucial role in immune function and may help reduce inflammation in the prostate. Magnesium, on the other hand, is involved in muscle relaxation and may help alleviate pelvic pain associated with prostatitis. Lastly, longjack, also known as Tongkat Ali, is a medicinal plant that has been used traditionally for its aphrodisiac properties. It has been suggested that longjack may help improve testosterone levels and enhance sexual function, which can be affected by prostatitis. While these herbal supplements show promise in managing prostatitis symptoms, it's important to note that they should not replace medical advice or prescribed treatments. Consulting with a healthcare professional is crucial to ensure proper diagnosis and determine the most appropriate course of action for managing prostatitis.

**Ingredients:** see Supplement Facts.

**Manufacturer Country:** USA

**Product Amount:** 90 caps

**Gross Weight:** 0.14lb (65g)

**Suggested Use:** Take three (3) capsules before bedtime.



of prostatitis. They help to strengthen the immune system, reduce inflammation, and improve overall gut and urinary tract health. Specific strains of probiotics, such as Lactobacillus and Bifidobacterium, have been shown to have antimicrobial properties and can inhibit the growth of pathogenic bacteria in the prostate. Moreover, probiotics can enhance the effectiveness of antibiotics, making them a potential adjuvant therapy for prostatitis.

**Ingredients:** See Supplement Facts.

**Manufacturer Country:** USA

**Product Amount:** 60 caps

**Gross Weight:** 0.25lb (113g)

**Suggested Use:** Take two (2) capsules once a day as a dietary supplement. For best results, take one (1) capsule during the day and one (1) capsule in the evening. Repeat the process daily. Do not exceed two capsules per day.

**Warning:** Keep out of reach of children. Do not use if the safety seal is damaged or missing. Store in a cool, dry place.

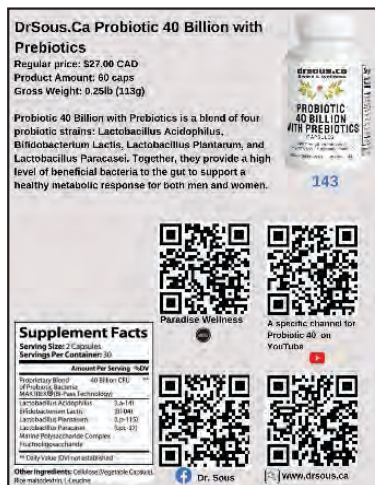

## 6. ERECTILE DYSFUNCTION

Erectile dysfunction (ED) is a medical condition in which a man has difficulty getting or maintaining an erection firm enough for sexual intercourse. It is important to address it because it can have a negative impact on a man's self-esteem, relationships, and overall well-being.

### Causes

Many medical and lifestyle factors contribute to erectile dysfunction that impedes satisfying sexual relations, these include:

- Lack of exercise and poor diet
- Relationship issues and hesitancy to communicate openly about sexual desires and anxieties
- Stress and inadequate sleep

### Symptoms

- Trouble getting an erection
- Trouble keeping an erection
- Reduced sexual desire

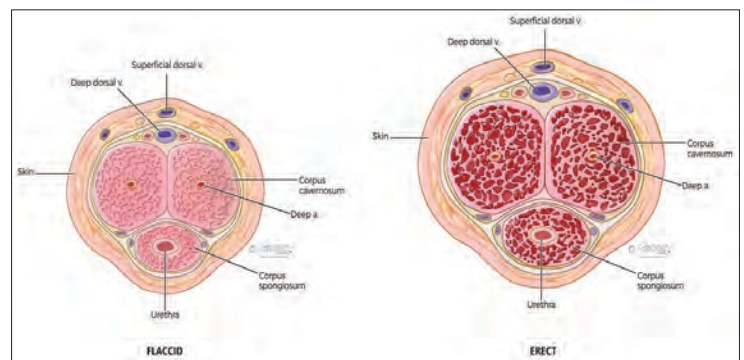





### 3. Ginkgo Biloba + Ginseng

Ginkgo Biloba and Ginseng are two natural supplements that have been used for centuries in traditional medicine to address various health concerns. In recent years, they have gained attention for their potential benefits in managing erectile dysfunction (ED), a condition that affects many men worldwide. Ginkgo Biloba, derived from the leaves of the ginkgo tree, is believed to improve blood circulation, including to the genital area, by dilating blood vessels and reducing inflammation. This increased blood flow can potentially enhance erectile function by aiding in the relaxation of smooth muscles and increasing the availability of oxygen and nutrients to the penile tissues. Additionally, ginseng, a root known for its adaptogenic properties, is believed to improve sexual function and overall well-being. Some studies suggest that ginseng may stimulate the production of nitric oxide, a compound that plays a crucial role in penile erection. Nitric oxide helps to relax the smooth muscles in the walls of blood vessels, promoting blood flow to the penis.

**Ingredients:** See Supplement Facts.

**Manufacturer Country:** USA

**Product Amount:** 60 caps

**Gross Weight:** 0.25lb (133g)

**Suggested Use:** As a dietary supplement, take two (2) capsules before bedtime or as directed by your healthcare professional.

**Warning:** Keep out of reach of children. Do not use if the safety seal is damaged or missing. Store in a cool, dry place.

The Food and Drug Administration has not evaluated these statements. This product is not intended to diagnose, treat, cure or prevent any disease.

**DrSous.ca Ginkgo Biloba + Ginseng**  
Regular price: \$29.90 CAD  
Product Amount: 60 caps  
Gross Weight: 0.25lb (133g)  
Ginkgo Biloba is a herb used in ancient Chinese medicine for its effective antioxidant properties. Ginkgo Biloba is one of the oldest and most-commonly-used brain supplement for better mental function. Combine it with Ginseng for benefits to blood flow, oxygen, nutrient absorption in the brain & to strengthen the immune system.

- Anti-aging
- Helps to combat cold and flu symptoms.
- Improved memory and cognition
- Strong antioxidant

Supplement Facts	
Serving Size: 2 Capsules	
Servings Per Container: 30	
Amount Per Serving %DV	
Red Panax Ginseng Extract (Standardized to 74% Ginsenosides)	500mg
Ginkgo Biloba Leaf Powder (Standardized to 24% Flavonoids)	500mg
Ginkgo Biloba Leaf 24% Flavonoids	120mg
** Daily Value (DV) not established	

Other Ingredients: Vegetable Cellulose, Hypromellose, Silica, Dextrose

QR Code: A specific channel for Ginkgo Biloba on YouTube

Paradise Wellness | Dr. Sous | www.drsous.ca

### 7. HYPOGONADISM

Hypogonadism means diminished functional activity of the gonads—the testes or the ovaries—that may result in diminished production of sex hormones. Hypogonadism occurs when the body's sex glands (gonads) produce little or no hormones. In men, these glands are the testes. In women, these glands are the ovaries.

#### Can hypogonadism be treated?

Adult men. Male hypogonadism usually is treated with testosterone replacement to return testosterone levels to normal. Testosterone can help counter the signs and symptoms of male hypogonadism, such as decreased sexual desire, decreased energy, decreased facial and body hair, and loss of muscle mass and bone density. Male hypogonadism is a condition in which the body doesn't produce enough of the hormone that plays a key role in masculine growth and development during puberty (testosterone) or enough sperm or both. You can be born with male hypogonadism, or it can develop later in life, often from injury or infection. The effects — and what you can do about them — depend on the cause and at what point in your life male hypogonadism occurs. Some types of male hypogonadism can be treated with testosterone replacement therapy.

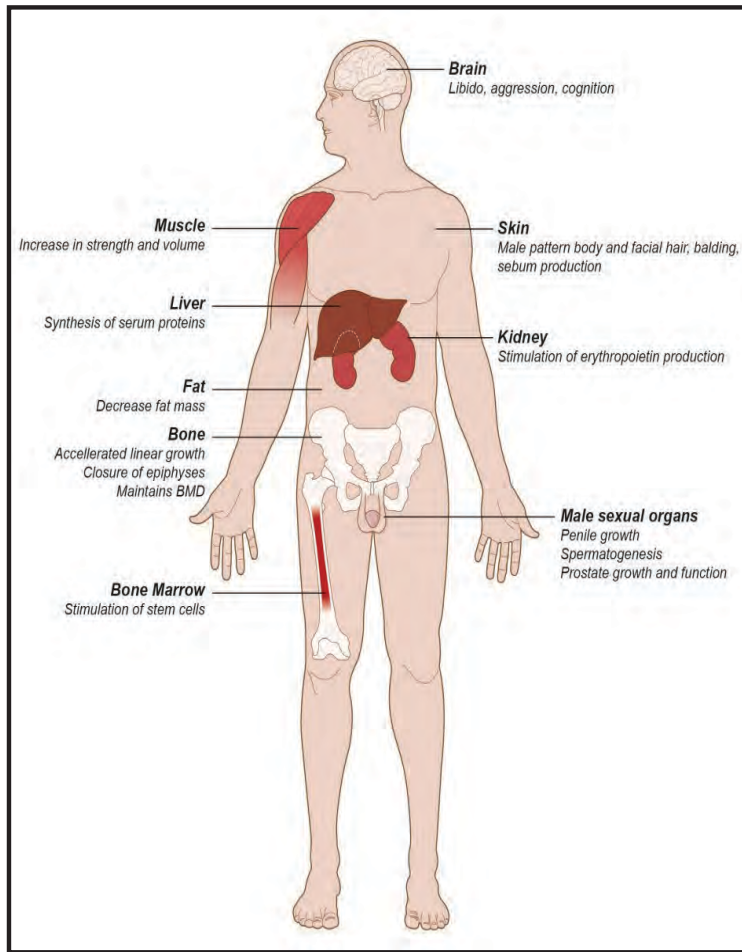

### # Symptoms

Hypogonadism can begin during fetal development, before puberty or during adulthood. Signs and symptoms depend on when the condition develops.

### Male reproductive system

The male reproductive system makes, stores and moves sperm. Testicles produce sperm. Fluid from the seminal vesicles and prostate gland combine with sperm to make semen. The penis ejaculates semen during sexual intercourse.

### Fetal development

If the body doesn't produce enough testosterone during fetal development, the result may be impaired growth of the external sex organs. Depending on when hypogonadism develops and how much testosterone is present, a child who is genetically male may be born with:

- Female genitals
- Genitals that are neither clearly male nor clearly female (ambiguous genitals)
- Underdeveloped male genitals

**The recommended supplements for hypogonadism are:** Testosterone Booster, Vitamin D3, & Ashwagandha.

### 1. Testosterone Booster

Hypogonadism is a medical condition characterized by low levels of testosterone in the body, affecting both men and women. Testosterone is a vital hormone responsible for various bodily functions, including the development of sexual characteristics, maintaining



age, underlying health conditions, and overall lifestyle. Therefore, consulting a healthcare professional is crucial before initiating any supplementation regimen.

**Ingredients:** see Supplement Facts.

**Manufacturer Country:** USA

**Product Amount:** 100 soft-gels

**Gross Weight:** 0.1lb (45g)

**Suggested Use:** As a dietary supplement, adults take one (1) soft-gel capsule daily or as directed by a health care professional. Store in a cool, dry place and away from direct light.

### 3. Ashwagandha

Ashwagandha, also known as *Withania somnifera*, is an ancient herb that has gained significant attention in recent years for its potential benefits in treating various health conditions. One such condition is hypogonadism, which refers to a deficiency in the production of testosterone and other reproductive hormones. Ashwagandha has been used in traditional Ayurvedic medicine for centuries to enhance male reproductive health and vitality. Studies have shown that this herbal remedy may have a positive impact on hypogonadism by stimulating the production of testosterone and improving overall hormonal balance. Ashwagandha contains active compounds called withanolides, which have demonstrated anti-inflammatory, antioxidant, and adaptogenic properties. These properties may help reduce oxidative stress and inflammation in the testes, leading to improved testosterone synthesis and release. Additionally, ashwagandha has shown potential in reducing cortisol levels, a stress hormone that can interfere with testosterone production. By lowering cortisol levels, ashwagandha may indirectly support the production and release of testosterone, thereby addressing the hormonal imbalances associated with hypogonadism. Furthermore, this powerful herb has been reported to enhance sperm quality, count, and motility, which are crucial factors in male fertility.

**Ingredients:** see Supplement facts.

**Manufacturer Country:** USA

**Amount:** 60 caps

**Gross Weight:** 0.25lb (113g)

**Suggested Use:** Take two (2) capsules once a day as a dietary supplement. For best results, take 20-30 min before a meal with an 8oz glass of water or as directed by your healthcare professional.

**Caution:** Do not exceed recommended dose. Pregnant or nursing mothers, children under the age of 18, and individuals with a known medical condition should consult a physician before using this or any dietary supplement.

**Warning:** This product is not intended to diagnose, treat, cure or prevent any disease. Keep out of reach of children. Do not use if the safety seal is damaged or missing. Store in a cool, dry place.

Supplement Facts	
Serving Size: 2 Capsules Servings Per Container: 30	
	Amount Per % Daily Serving Value
Organic Ashwagandha (Withania somnifera)(root)	1300mg
Organic Black Pepper (Piper nigrum)(fruit)	10mg
*Daily Value not established.	
Inactive Ingredients: Phuljari capsules.	

## 9. VARICOCELE

A varicocele (VAR-ih-koe-seel) is an enlargement of the veins within the loose bag of skin that holds the testicles (scrotum). These veins transport oxygen-depleted blood from the testicles. A varicocele occurs when blood pools in the veins rather than circulating efficiently out of the scrotum. A varicocele is when veins become enlarged inside your scrotum (the pouch of skin that holds your testicles). These veins are called the pampiniform plexus. Out of 100 males, 10 to 15 have varicocele. It is like getting a varicose vein in your leg. Varicoceles are when the pampiniform plexus veins in the scrotum become enlarged. These veins are like varicose veins (twisted, swollen veins found in the leg.) Varicoceles form during puberty. They can grow larger, and you may notice them more over time. Varicoceles are more common on the left side of the scrotum. This is because the male anatomy is not the same on both sides. Varicoceles can exist on both sides at the same time, but this is rare. About 10 to 15 boys out of 100 have a varicocele.

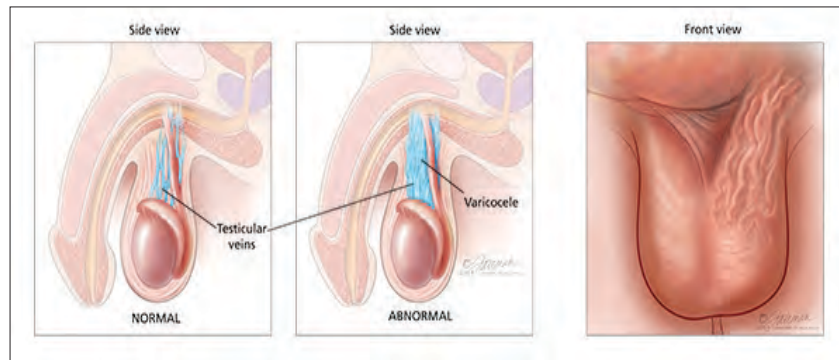

Most of the time, varicoceles cause no problems and are harmless. Less often varicoceles can cause pain, problems fathering a child or one testicle to grow slower or shrink.

### # Symptoms

Most males with a varicocele have no symptoms. But varicoceles are a concern for many reasons. Some may cause infertility (problems fathering a child) and slow growth of the left testicle during puberty. Varicoceles may be the cause of fertility problems in about four out of ten men who have problems fathering their first child. They may also be the cause of fertility problems in about eight out of ten men who have problems fathering a child after their first.

**The recommended supplements for varicocele are:** Vitamin C, Collagen, & Ginkgo Biloba + Ginseng.

### 1. Vitamin C

Vitamin C, also known as ascorbic acid, is a vital nutrient that plays a crucial role in maintaining overall health and well-being. It is known for its antioxidant properties, which can help combat oxidative stress and reduce inflammation. Some studies suggest that Vitamin C may have a positive impact on varicocele by improving blood flow and reducing the risk of oxidative damage to the veins. Furthermore, it is believed to strengthen the connective tissues and promote collagen synthesis, potentially aiding in the repair and maintenance of the affected veins. However, it is important to note that while Vitamin C supplementation may offer potential benefits, it should not be considered as a standalone treatment for varicocele. Consulting with a healthcare professional is crucial to determine the most appropriate course of action, as they can provide a comprehensive assessment and guidance tailored to individual needs. Additionally, it is essential to maintain a balanced diet and consider other lifestyle modifications, such as regular exercise and avoiding prolonged periods of sitting or standing, to manage varicocele effectively. Our Vitamin C Gummies are a healthy, on-the-go snack for the whole family. They provide you with the daily Vitamin C that your body needs to fight off free radicals, lower blood pressure, lower the risk of heart disease and boost the immune system against infection overall.

**Ingredients:** Vitamin C (as Ascorbic Acid), Glucose Syrup, Sugar, Glucose, Apple Juice (from concentrate), Pectin, Citric Acid, Sodium Citrate, Natural Strawberry flavor, Radish Red.

**Manufacturer Country:** USA



### 3. Ultra Vitamin for Men

The unique formulation of Ultra Vitamin for Men aims to provide essential nutrients that may support overall male reproductive health and potentially alleviate some of the symptoms associated with varicocele. This supplement is specifically designed to address the specific nutritional needs of men, with key ingredients such as vitamins, minerals, antioxidants, and herbal extracts that are believed to promote optimal reproductive function. These ingredients include vitamin E, selenium, zinc, and antioxidants like lycopene and coenzyme Q10, which have been shown to have potential benefits for male fertility. Additionally, Ultra Vitamin for Men may also contain herbal extracts such as saw palmetto and ginkgo biloba, which are believed to support prostate health and improve blood circulation. By providing these essential nutrients, Ultra Vitamin for Men aims to enhance overall reproductive health and potentially reduce the symptoms associated with varicocele.



### 4. Ginkgo Biloba + Ginseng

Ginkgo Biloba, derived from one of the oldest living tree species, has been used in traditional medicine for centuries. It is believed to improve blood circulation and reduce inflammation, which can be beneficial for varicocele patients. Additionally, Ginkgo Biloba is known for its antioxidant properties, which may help protect the blood vessels from oxidative stress. Ginseng, another well-known herbal remedy, is believed to enhance energy levels, improve blood flow, and strengthen the immune system. Some studies suggest that Ginseng may have anti-inflammatory effects and could potentially alleviate the symptoms of varicoceles.

**Ingredients:** See Supplement Facts.

**Manufacturer Country:** USA

**Product Amount:** 60 caps

**Gross Weight:** 0.25lb (133g)

**Suggested Use:** As a dietary supplement, take two (2) capsules before bedtime or as directed by your healthcare professional.

**Warning:** Keep out of reach of children. Do not use if the safety seal is damaged or missing.

Store in a cool, dry place.

The Food and Drug Administration has not evaluated these statements. This product is not intended to diagnose, treat, cure or prevent any disease.

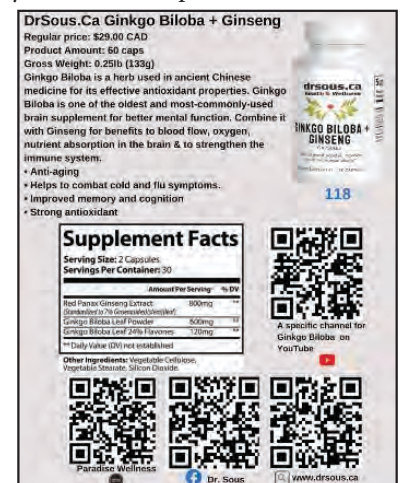



## 10. EPIDIDYMITIS

Epididymitis is an inflammation of the coiled tube, called the epididymis, at the back of the testicle. Symptoms of epididymitis might include: A swollen, discolored or warm scrotum. Testicle pain and tenderness, usually on one side, that often comes on slowly.

### What is epididymitis?

Epididymitis is inflammation of your epididymis, a coiled tube at the back of your testicle that stores and carries sperm. This swelling can cause intense testicular pain.

What's the difference between epididymitis and orchitis?

While epididymitis refers to inflammation of the tube at the back of your testicle, orchitis refers to swelling of your testicle itself. Sometimes, these two conditions occur simultaneously. When this happens, it's called epididymo-orchitis.

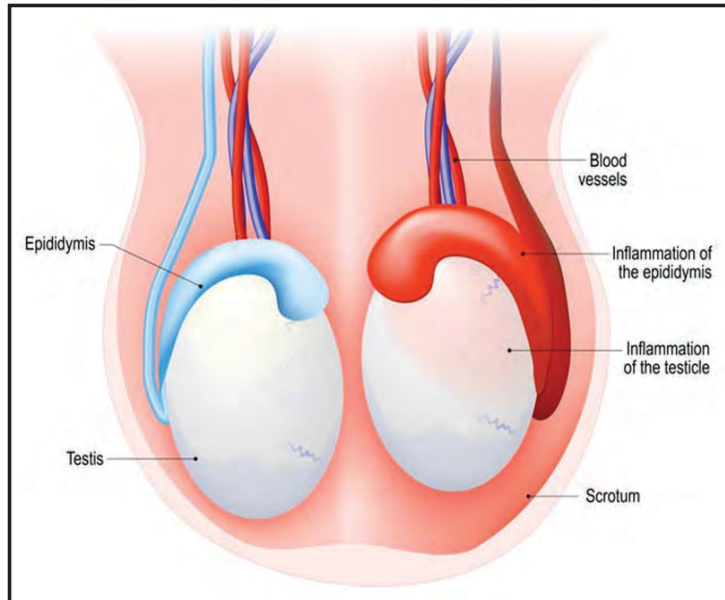

### Who does epididymitis affect?

Epididymitis can occur at any age, though it happens most often in people between the ages of 14 and 35. Men and people assigned male at birth can develop epididymitis.

### # Symptoms

#### What are the symptoms of epididymitis?

Epididymitis symptoms may include:

- Pain in your scrotum, sometimes moving to the rest of your groin.
- Swelling and redness in your testicle.
- Blood in your semen.
- Fever and chills.
- Dysuria (painful urination).
- Blockage in your urethra (the tube that carries pee from your body).
- An enlarged or infected prostate gland (a muscular, walnut-sized gland that surrounds part of your urethra).
- Use of a catheter (a tube that drains your bladder).
- Surgery on the prostate, urethra or bladder.
- Traumatic groin injury.

**The recommended supplements for Epididymitis are:** Platinum Turmeric, Vitamin C, & Organic Spirulina.

## 1. Platinum Turmeric

Epididymitis is a medical condition characterized by the inflammation of the epididymis, a coiled tube located behind the testicles. It can cause pain, swelling, and discomfort in the scrotum, and if left untreated, it may lead to complications such as abscess formation or infertility. While there are various treatment options available, one natural remedy that has gained attention is platinum turmeric. Turmeric, a vibrant yellow spice derived from the *Curcuma longa* plant, has long been valued for its potent anti-inflammatory and antioxidant properties. It contains a bioactive compound called curcumin, which has been extensively researched for its therapeutic benefits. Platinum turmeric, a specially formulated version of curcumin, offers enhanced bioavailability, meaning that it is more easily absorbed and utilized by the body. This increased bioavailability allows for higher concentrations of curcumin to reach the affected area, potentially aiding in reducing inflammation and alleviating symptoms associated with epididymitis. Additionally, curcumin has been shown to possess antimicrobial properties, making it potentially effective against bacterial causes of epididymitis. While further research is needed to establish the efficacy of platinum turmeric specifically for epididymitis, the existing scientific evidence regarding the anti-inflammatory and antimicrobial properties of curcumin suggests that it may be a promising natural alternative for individuals seeking complementary or adjunctive treatment options.

**Ingredients:** see Supplement Facts.

**Manufacturer Country:** USA

**Product Amount:** 60 caps

**Gross Weight:** 0.25lb (113g)

**DrSous.Ca Platinum Turmeric 60 Capsule Bottle**  
Regular price: \$20.00 CAD  
Product Amount: 60 caps  
Gross Weight: 0.25lb (113g)  
Our Platinum Turmeric blend contains various forms of turmeric, glucosamine, Boswellia extract (frankincense), piperine, and several other highly beneficial natural extracts to keep you at your best.

- Anti-inflammatory
- Joint and Bone health
- Heart Protective
- Anti-oxidant & Anti- Cancer

**Supplement Facts**

	Amount Per Serving %DV
Platinum Turmeric Blend (Turmeric, Curcumin, Piperine, Boswellia, and other natural extracts)	1000mg 100%
Glucosamine HCl	500mg 100%
Boswellia Extract (Frankincense)	100mg 100%
Other Natural Extracts	100mg 100%
<b>Total</b>	<b>1700mg</b>

Other Ingredients: Cellulose, Hydroxypropyl Methylcellulose, Magnesium Stearate, and Natural Flavors.

©2014 Dr. Sous. All rights reserved. [www.drsous.ca](http://www.drsous.ca)

## 2. Vitamin C

Vitamin C, also known as ascorbic acid, plays a crucial role in maintaining a healthy immune system and promoting overall well-being. While there is limited scientific evidence specifically linking vitamin C to the treatment of epididymitis, it is widely recognized for its beneficial effects on the immune system and its ability to reduce inflammation. Vitamin C is a powerful antioxidant that helps protect cells from damage caused by free radicals, which can contribute to inflammation and tissue damage. By boosting the immune system, vitamin C may support the body's ability to fight off infections and reduce the severity of symptoms associated with epididymitis. Moreover, vitamin C has been shown to enhance the production of collagen, a protein that is essential for the repair and regeneration of tissues. This may aid in the healing process of the inflamed epididymis. It is worth noting that while vitamin C can be obtained through a healthy diet that includes fruits and vegetables such as oranges, strawberries, kiwi, broccoli, and peppers, supplements are also available for those who may need higher doses.

Our Vitamin C Gummies are a healthy, on-the-go snack for the whole family. They provide you with the daily Vitamin C that your body needs to fight off free radicals, lower blood pressure, lower the risk of heart disease and boost the immune system against infection overall.

**Ingredients:** Vitamin C (as Ascorbic Acid), Glucose Syrup, Sugar, Glucose, Apple Juice (from concentrate), Pectin, Citric Acid, Sodium Citrate, Natural Strawberry flavor, Radish Red.

**Manufacturer Country:** USA

**Product Amount:** 60 gummies

**Gross Weight:** 0.37lb (170g)

**Suggested Use:** Take two (2) capsules once a day as a dietary supplement.

**Caution:** Do not exceed recommended dose. Pregnant or nursing mothers, children under the age of 18, and individuals with a known medical condition should consult a physician before using this or any dietary supplement.

**DrSous.Ca Vitamin C Gummies**  
Regular price: \$12.55 CAD  
Product Amount: 60 gummies  
Gross Weight: 0.37lb (170g)  
Vitamin C Gummies are an effective way to get the necessary daily Vitamin C for your body. They provide you with the daily Vitamin C that your body needs to fight off free radicals, lower blood pressure, lower the risk of heart disease and boost the immune system against infection overall.

Amount Per Serving	%DV*
Calories	12
Calories from Fat	0
Total Carbohydrates	3g 1%
Sugar	2g 4%
Vitamin C (as Ascorbic Acid)	60mg 67%

\*The % Daily Value (%DV) tells you how much a nutrient in a serving of food contributes to a daily diet. 2,000 calories a day is used for general nutrition advice.

A specific channel for Vitamin C on YouTube

Paradise Wellness | Dr. Sous | www.drsous.ca

### 3. Organic Spirulina

Spirulina contains a wide array of essential nutrients, such as vitamins, minerals, antioxidants, and amino acids, which contribute to its therapeutic properties. The high levels of antioxidants found in spirulina can help reduce inflammation, which is a primary symptom of epididymitis. By neutralizing free radicals and minimizing oxidative stress, spirulina promotes a healthier immune response, aiding in the body's fight against infection. Moreover, spirulina's natural anti-inflammatory properties can help alleviate pain and discomfort associated with epididymitis. Its rich nutritional profile, including vitamins A, C, E, and B-complex vitamins, helps strengthen the immune system, promoting faster recovery. Additionally, spirulina contains gamma-linolenic acid (GLA), an omega-6 fatty acid that possesses anti-inflammatory properties. GLA helps regulate the body's inflammatory response, reducing swelling and pain. Furthermore, spirulina's immune-boosting properties can enhance overall well-being and support the body in its healing process. It is important to note that while organic spirulina can offer potential benefits for epididymitis, it should not replace medical treatment.

Our Organic Spirulina Powder is rich in essential amino acids lysine, methionine, cysteine, threonine, and phenylalanine which are crucial for supporting regular body functions. Furthermore, Spirulina has very high levels of iron, beta-carotene, and B vitamins.

Spirulina is the perfect addition to your favorite smoothies and smoothie bowls.

**Ingredients:** see Supplement Facts.

**Manufacturer Country:** USA

**Product Amount:** 0.26lb (120g)

**Gross Weight:** 0.27lb (125g)

**Suggested Use:** The recommended starting dosage is ½ teaspoon a day, gradually increasing to 3 teaspoons, taken with food or around an hour before mealtimes.

**Warning:** Keep out of reach of children. Do not use if the safety seal is damaged or missing. Store in a cool, dry place.

**DrSous.Ca Organic Spirulina Powder 120g**  
Regular price: \$15.00 CAD  
Product Amount: 0.26lb (120g)  
Gross Weight: 0.27lb (125g)  
Spirulina is a blue-green algae known for its high protein level and dense nutrient content. Our Organic Spirulina Powder is rich in essential amino acids: lysine, methionine, cysteine, threonine, and phenylalanine which are crucial for supporting regular body functions. It is anti-aging & anti-inflammatory.

Amount Per Serving	% Daily Value*
Vitamin A	400 IU 80%
Vitamin C	30 mg 30%
Iron	2.1 mg 15%
Alpha-Lipoic Acid	5.1 mg 10%
Biotin	1.2 mg 2%
Vitamin B6	5.1 mg 10%
Beta	2.1 mg 4%
Phosphorus	30 mg 6%
Calcium	30 mg 6%
Magnesium	40 mg 10%
Copper	0.2 mg 20%
Manganese	0.1 mg 10%
Selenium	0.1 mg 2%

\*Percent Daily Values are based on a diet of other people's secrets.

Ingredients: 100% Spirulina powder (Arthrospira platensis)

A specific channel for Spirulina on YouTube

Paradise Wellness | Dr. Sous | www.drsous.ca

## CHAPTER VI. DIABETES, PANCREAS & WEIGHT LOSS

Diabetes is a condition that happens when your blood sugar (glucose) is too high. It develops when your pancreas doesn't make enough insulin or any at all, or when your body isn't responding to the effects of insulin properly. Diabetes affects people of all ages. Most forms of diabetes are chronic (lifelong), and all forms are manageable with medications and/or lifestyle changes.

What are the types of diabetes?

There are several types of diabetes. The most common forms include:

- **Type 2 diabetes:** With this type, your body doesn't make enough insulin and/or your body's cells don't respond normally to the insulin (insulin resistance). This is the most common type of diabetes. It mainly affects adults, but children can have it as well.
- **Prediabetes:** This type is the stage before Type 2 diabetes. Your blood glucose levels are higher than normal but not high enough to be officially diagnosed with Type 2 diabetes.
- **Type 1 diabetes:** This type is an autoimmune disease in which your immune system attacks and destroys insulin-producing cells in your pancreas for unknown reasons. Up to 10% of people who have diabetes have Type 1. It's usually diagnosed in children and young adults, but it can develop at any age.
- **Gestational diabetes:** This type develops in some people during pregnancy. Gestational diabetes usually goes away after pregnancy. However, if you have gestational diabetes, you're at a higher risk of developing Type 2 diabetes later in life.

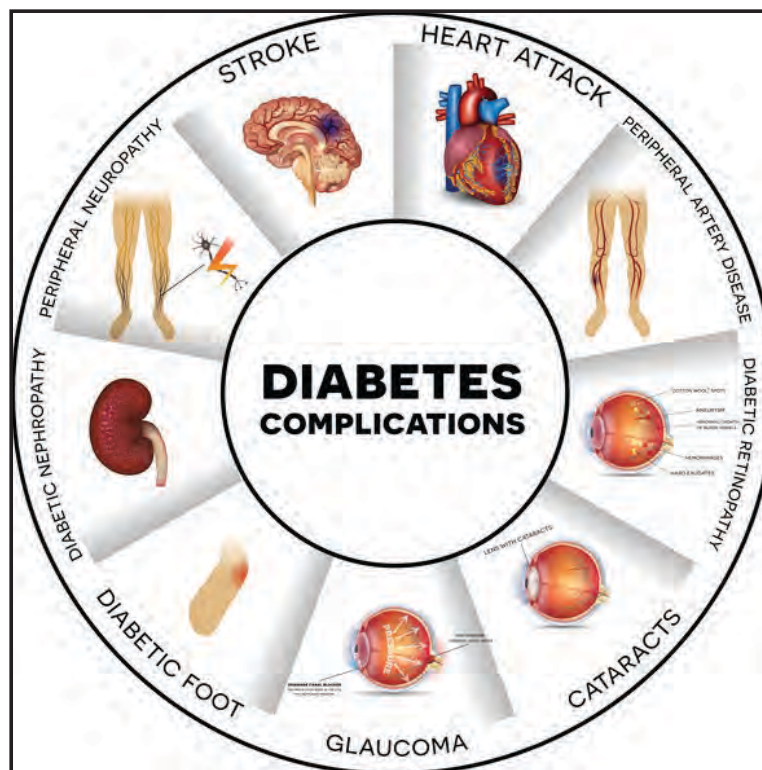

### 1. TYPE 1 DIABETES

People of all ages can develop type 1 diabetes. If you have type 1 diabetes, your pancreas doesn't make insulin or makes very little insulin. Insulin helps blood sugar enter the cells in your body for use as energy. Without insulin, blood sugar can't get into cells and builds up in the bloodstream.

**What is the meaning of diabetes type 1?**

Overview. Type 1 diabetes, once known as juvenile diabetes or insulin-dependent diabetes, is a chronic condition. In this condition, the pancreas makes little or no insulin. Insulin is a hormone the body uses to allow sugar (glucose) to enter cells to produce energy.

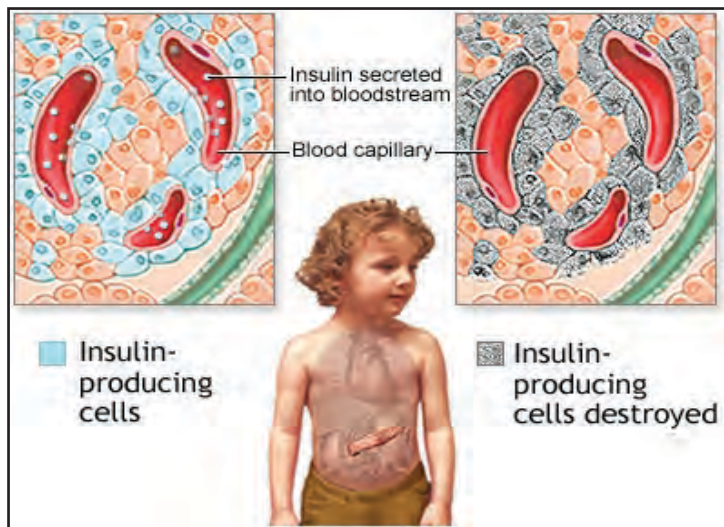

Type 1 diabetes typically occurs in children and young adults, although it can appear at any age. Having a parent or sibling with the disease may increase your chance of developing type 1 diabetes. In the United States, about 5 percent of people with diabetes have type 1.

### What are the symptoms of type 1 diabetes?

Symptoms of type 1 diabetes are serious and usually happen quickly, over a few days to weeks. Symptoms can include

- increased thirst and urination
- increased hunger
- blurred vision
- fatigue
- unexplained weight loss

Sometimes the first symptoms of type 1 diabetes are signs of a life-threatening condition called diabetic ketoacidosis (DKA). Some symptoms of DKA include

- breath that smells fruity
- dry or flushed skin
- nausea or vomiting
- stomach pain
- trouble breathing
- trouble paying attention or feeling confused

DKA is serious and dangerous. If you or your child have symptoms of DKA, contact your healthcare professional right away, or go to the nearest hospital emergency room.

**The recommended supplements for Type 1 Diabetes are:** Moringa Pure, Magnesium Glycinate, CoQ10, & Vitamin D3.

#### 1. Moringa Pure

Moringa, also known as the “Miracle Tree,” has gained significant attention in recent years for its potential health benefits, particularly in managing type 1 diabetes. Type 1 diabetes is a chronic autoimmune condition where the body’s immune system attacks and destroys the insulin-producing cells in the pancreas, leading to insulin deficiency. While there is no cure for type 1 diabetes, research suggests that moringa may offer some promising effects in helping to regulate blood sugar levels and alleviate symptoms associated with the disease. Moringa leaves are rich in essential nutrients, including vitamins, minerals, and antioxidants, making them a valuable addition to the diet of individuals with diabetes. These leaves have been found to contain compounds that mimic the effects of insulin and improve glucose uptake by cells, contributing to better blood sugar control. Additionally, studies have shown that moringa may possess anti-inflammatory properties, which can be beneficial for individuals with type 1 diabetes, as inflammation is often a key factor in the

development and progression of the disease. Furthermore, moringa has been reported to have a positive impact on lipid metabolism, potentially reducing the risk of complications associated with diabetes, such as cardiovascular diseases.

**Ingredients:** see Supplement Facts.

**Manufacturer Country:** USA

**Product Amount:** 60 caps

**Gross Weight:** 0.25lb (113g)

**Suggested Use:** Take two (2) capsules once a day as a dietary supplement. For best results, take 20-30 min before a meal with an 8oz glass of water or as directed by your healthcare professional.

**Caution:** Do not exceed recommended dose. Pregnant or nursing mothers, children under the age of 18, and individuals with a known medical condition should consult a physician before using this or any dietary supplement.

**Warning:** Keep out of reach of children. Do not use if the safety seal is damaged or missing. Store in a cool, dry place.

The Food and Drug Administration has not evaluated these statements. This product is not intended to diagnose, treat, cure or prevent any disease.

**DrSous.Ca Moringa Pure 60 Capsules Bottle**  
Regular price: \$12.00 CAD  
Product Amount: 60 caps  
Gross Weight: 0.25lb (113g)  
Moringa Oleifera is a tree that originates from Northern India and has been praised for its health benefits for centuries. Almost all parts of the tree are used in traditional medicine, where people can expect to get a high dose of protein, Vitamin C, Vitamin B6, Riboflavin, and iron.

Amount Per Serving	% Daily Value
Moringa Oleifera (leaf)	800 mg

\*Daily Value not established.

**Inactive Ingredients:** Cellulose (vegetable capsule).

131

A specific channel for Moringa Pure on YouTube

Paradise Wellness | Dr. Sous | www.drsous.ca

## 2. Magnesium Glycinate

Magnesium Glycinate is a form of magnesium that has gained attention for its potential benefits in managing type 1 diabetes. Type 1 diabetes is a chronic condition characterized by the body's inability to produce insulin, leading to high blood sugar levels. While insulin therapy is the primary treatment for type 1 diabetes, some studies suggest that magnesium supplementation, specifically in the form of Magnesium Glycinate, may offer additional support. Magnesium is an essential mineral involved in various biochemical processes in the body, including glucose metabolism and insulin action. It is believed that Magnesium Glycinate's unique formulation enhances its bioavailability and absorption, making it an effective option for individuals with type 1 diabetes. Research indicates that magnesium supplementation may improve insulin sensitivity, enhance glucose control, and reduce the risk of complications associated with diabetes. Additionally, Magnesium Glycinate has been shown to possess anti-inflammatory and antioxidant properties, which may further benefit individuals with type 1 diabetes by reducing oxidative stress and inflammation.

**Magnesium Glycinate**

Magnesium Glycinate is one of the most important nutrients needed throughout the body. It is most commonly used as a natural sleep vitamin that helps calm the brain, to help the body relax and fall and stay asleep. By doing this, the body is able to be rejuvenated.

160

A specific channel for Supplements on YouTube

www.paradisewellness.ca | Dr. Sous | www.drsous.ca

### 3. CoQ10

Coenzyme Q10, commonly known as CoQ10, is a naturally occurring compound that plays a vital role in cellular energy production. It is found in every cell of the body and is particularly abundant in organs that require high energy, such as the heart, liver, and kidneys. While CoQ10 is often associated with cardiovascular health, emerging research suggests that it may also have potential benefits for individuals with type 1 diabetes. Type 1 diabetes is an autoimmune condition in which the immune system mistakenly attacks and destroys the insulin-producing cells in the pancreas. As a result, individuals with type 1 diabetes require lifelong insulin therapy to regulate their blood sugar levels. However, despite advancements in insulin therapy, managing blood sugar levels can still be challenging for many individuals with type 1 diabetes. Several studies have explored the potential role of CoQ10 in managing type 1 diabetes. One study published in the journal “Diabetes Care” found that CoQ10 supplementation improved blood sugar control and reduced the risk of complications in individuals with type 1 diabetes. The researchers suggested that CoQ10 may enhance insulin sensitivity and improve beta-cell function, leading to better glucose control. Another study conducted at the University of California, San Diego, found that CoQ10 supplementation improved endothelial function in individuals with type 1 diabetes. Endothelial dysfunction, characterized by impaired blood vessel function, is a common complication of diabetes and contributes to the development of cardiovascular disease. By improving endothelial function, CoQ10 may help reduce the risk of cardiovascular complications in individuals with type 1 diabetes. Furthermore, CoQ10 has been shown to possess antioxidant properties, which can help reduce oxidative stress and inflammation, both of which play a role in the development and progression of type 1 diabetes. A study published in the journal “Pediatric Diabetes” reported that CoQ10 supplementation reduced markers of oxidative stress in children with type 1 diabetes, suggesting a potential protective effect on pancreatic beta cells.

**Ingredients:** see Supplement Facts.

**Manufacturer Country:** USA

**Product Amount:** 30 caps

**Gross Weight:** 0.25lb (113g)

**Suggested Use:** Take one (1) capsule twice a day as a dietary supplement. For best results, take 20-30 min before a meal or as directed by your healthcare professional.

**Caution:** Do not exceed recommended dose. Pregnant or nursing mothers, children under the age of 18, and individuals with a known medical condition should consult a physician before using this or any dietary supplement.

**Warning:** Keep out of reach of children. Do not use if the safety seal is damaged or missing. Store in a cool, dry place.

The Food and Drug Administration has not evaluated these statements. This product is not intended to diagnose, treat, cure or prevent any disease.



### 4. Vitamin D3

Vitamin D3 has been a topic of interest in recent years for its potential benefits in managing type 1 diabetes. Type 1 diabetes is an autoimmune disease characterized by the destruction of insulin-producing cells in the pancreas, leading to a deficiency of insulin. Re-

search suggests that vitamin D3, also known as cholecalciferol, may play a role in modulating the immune system and reducing the risk of developing type 1 diabetes. Vitamin D3 is primarily synthesized in the skin upon exposure to sunlight, but it can also be obtained through dietary sources such as fatty fish, fortified dairy products, and supplements. Studies have shown that individuals with type 1 diabetes tend to have lower levels of vitamin D3 compared to those without the condition. This deficiency may be attributed to various factors, including limited sun exposure, decreased dietary intake, and impaired absorption in the gut. Several mechanisms have been proposed to explain the potential benefits of vitamin D3 in type 1 diabetes. Firstly, it is believed that vitamin D3 may help regulate the immune response and reduce the destruction of insulin-producing cells. Vitamin D3 has immunomodulatory properties that can influence the activity of immune cells, such as T cells and B cells, which are involved in the autoimmune response seen in type 1 diabetes. By modulating the immune system, vitamin D3 may help prevent or slow down the autoimmune destruction of insulin-producing cells, thereby preserving their function. Furthermore, studies have suggested that vitamin D3 may have a role in improving insulin sensitivity and glycemic control in individuals with type 1 diabetes. Insulin sensitivity refers to the body's ability to respond to insulin and effectively utilize glucose for energy. Research has shown that vitamin D3 supplementation may improve insulin sensitivity in individuals with type 1 diabetes, leading to better blood sugar control. This effect may be particularly beneficial in reducing the risk of long-term complications associated with poorly controlled diabetes, such as cardiovascular disease and kidney damage.

**Ingredients:** see Supplement Facts.

**Manufacturer Country:** USA

**Product Amount:** 100 soft-gels

**Gross Weight:** 0.1lb (45g)

**Suggested Use:** As a dietary supplement, adults take one (1) soft-gel capsule daily or as directed by a health care professional. Store in a cool, dry place and away from direct light.



## 2. TYPE 2 DIABETES

Type 2 diabetes is a lifelong disease that keeps your body from using insulin the way it should. People who are middle-aged or older are most likely to get this kind of diabetes. It used to be called adult-onset diabetes or diabetes mellitus. But type 2 diabetes also affects kids and teens, mainly because of childhood obesity.

Type 2 is the most common form of diabetes. About 1 in 10 people in the U.S. have type 2.

### Who can develop type 2 diabetes?

Anyone can develop type 2 diabetes. Some things that indicate an increased risk of having diabetes are:

- Having a close relative with the disease
- Being a member of a high-risk group including Aboriginal, Hispanic, South Asian, Asian, or African descent
- Having high blood pressure or cholesterol,
- Being overweight



## Why does the heart matter in type 2 diabetes?

- For Canadians living with type 2 diabetes, death from heart disease is a serious risk. Heart disease is the **#1 cause of death** in people with type 2 diabetes.
- People with type 2 diabetes **develop heart disease 15 years earlier** compared to people without diabetes
- If you have type 2 diabetes and a history of heart disease, diet and exercise may not be enough to protect your heart.

## # Symptoms

Type 2 diabetes is caused by several different risk factors. Some of these factors can be controlled or managed (like high blood pressure or smoking) while other factors (like having a higher-risk ethnic background) can't be controlled.

The most common signs and symptoms of type 2 diabetes can include the following:

- unusual thirst
- frequent urination
- weight change (gain or loss)
- extreme fatigue or lack of energy
- blurred vision
- frequent or recurring infections
- cuts and bruises that are slow to heal
- tingling or numbness in the hands or feet
- trouble getting or maintaining an erection
- Diabetic ketoacidosis (DKA).

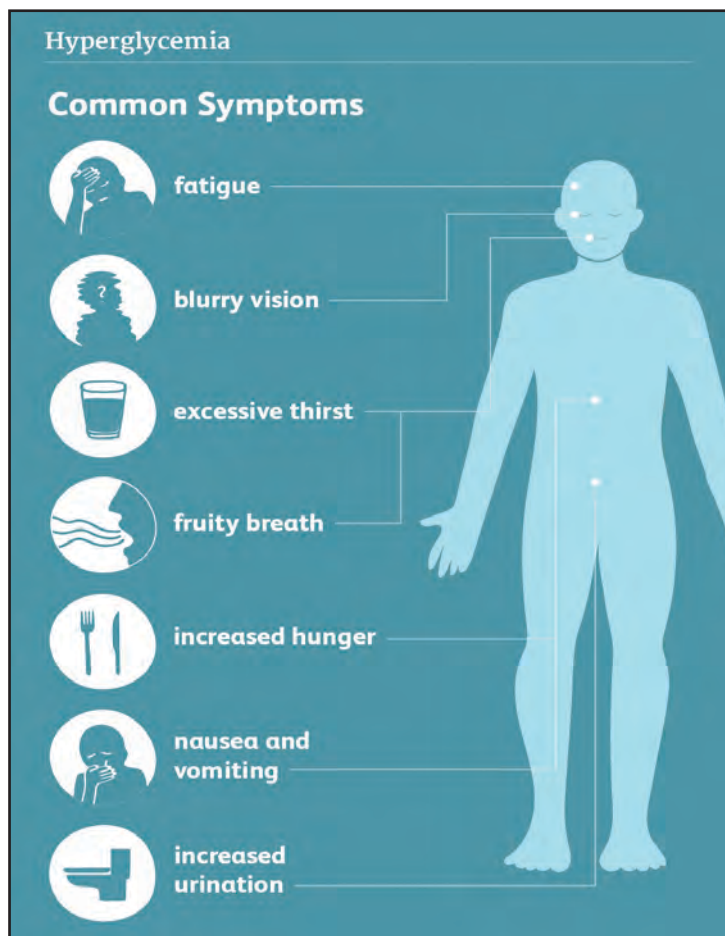

The most recommended supplements for Type 2 diabetes are: Resveratrol, CoQ10, Magnesium Glycinate.

## 1. Resveratrol

Resveratrol, a natural compound found in various plants, has gained considerable attention in recent years for its potential benefits in managing type 2 diabetes. Type 2 diabetes is a chronic condition characterized by insulin resistance and high blood sugar levels. Resveratrol has been found to possess anti-diabetic properties that can help in the management of this condition. Studies have shown that resveratrol can improve insulin sensitivity, which is crucial for glucose uptake and utilization by the cells. By enhancing insulin sensitivity, resveratrol helps to regulate blood sugar levels and prevent the development of insulin resistance. Additionally, resveratrol has been found to have anti-inflammatory and antioxidant effects, which can further benefit individuals with type 2 diabetes. Chronic inflammation and oxidative stress are known to contribute to the progression of diabetes and its complications. Resveratrol's ability to reduce inflammation and neutralize harmful free radicals can help protect against the damage caused by these processes. Furthermore, resveratrol has been shown to improve lipid profiles by decreasing levels of total cholesterol, LDL cholesterol, and triglycerides, while increasing levels of HDL cholesterol, commonly referred to as the "good" cholesterol. This lipid-lowering effect of resveratrol can help reduce the risk of cardiovascular complications, which are often associated with type 2 diabetes.

Resveratrol is a plant compound with potent antioxidant functionality. Resveratrol is found mainly in red wine, red grapes, berries, and peanuts. It is most concentrated in the skin of grape skins and seeds.

Resveratrol has been linked to many exciting health benefits, such as lowering cholesterol, supporting brain health, and controlling weight loss. These, coupled with antioxidant abilities, make the perfect daily supplement.

**Ingredients:** see Supplement Facts.

**Manufacturer Country:** USA

**Product Amount:** 60 caps

**Gross Weight:** 0.25lb (113g)

**Suggested Use:** Take one (1) veggie capsule twice a day as a dietary supplement. For best results, take 20-30 min before a meal or as directed by your healthcare professional.

**DRSOUS.CA Resveratrol 50%  
600mg Antioxidant**  
Regular price \$28.00 CAD  
Product Amount: 60 caps  
Gross Weight: 0.25lb (113g)  
Resveratrol is an antioxidant-like compound that promotes heart health, brain health and supports weight loss.  
• Cardiovascular health  
• Antioxidant  
• Weight control  
• Anti-aging

Supplement Facts	
Serving Size: 1 Capsule Servings Per Container: 60	
	Amount Per % Daily Serving Value
Resveratrol (Polyphenol capsulinate) (100%)	600mg **
Complex Contains 50% Trans-Resveratrol	

\*\* % Daily Value not established  
Other Ingredients: Vegetable Capsule (Cellulose), Microcrystalline Cellulose.

Paradise Wellness | Dr. Sous | www.drsous.ca

A specific channel for Resveratrol on YouTube

## 2. CoQ10

Coenzyme Q10 (CoQ10) has gained significant attention as a potential supplement for managing type 2 diabetes. Type 2 diabetes is a chronic condition characterized by high blood sugar levels due to insulin resistance or inadequate insulin production. CoQ10, a naturally occurring antioxidant and essential component of cellular energy production, has been studied for its potential effects on glucose metabolism and insulin sensitivity. Research suggests that CoQ10 supplementation may improve glycemic control and reduce the risk of complications associated with type 2 diabetes. Several studies have shown that CoQ10 supplementation can lower fasting blood glucose levels and HbA1c, a long-term marker of blood sugar control. Moreover, CoQ10 has been found to enhance insulin sensitivity and improve beta-cell function, which is responsible for insulin production. It is believed that CoQ10's antioxidant properties help reduce oxidative stress and inflammation, which are key factors in the development and progression of type 2 diabetes. Additionally, CoQ10 may have a protective effect on the cardiovascular system, which is particularly important for individuals with type 2 diabetes.

who are at a higher risk of heart disease.

**Ingredients:** see Supplement Facts.

**Manufacturer Country:** USA

**Product Amount:** 30 caps

**Gross Weight:** 0.25lb (113g)

**Suggested Use:** Take one (1) capsule twice a day as a dietary supplement. For best results, take 20-30 min before a meal or as directed by your healthcare professional.

**Caution:** Do not exceed recommended dose. Pregnant or nursing mothers, children under the age of 18, and individuals with a known medical condition should consult a physician before using this or any dietary supplement.

**Warning:** Keep out of reach of children. Do not use if the safety seal is damaged or missing. Store in a cool, dry place.

The Food and Drug Administration has not evaluated these statements. This product is not intended to diagnose, treat, cure or prevent any disease.

**DRSOUS.CA CoQ10 Ubiquinone energy production source supplement 30 Capsules**  
Regular price: \$24.00 CAD  
Amount: 30 caps  
Gross Weight: 0.25lb (113g)  
Coenzyme Q10 (CoQ10) is an antioxidant and vitamin-like compound that is found naturally in the body and in some foods like oily fish (salmon and tuna) and organ meats (liver).

Amount Per Serving	%DV
Coenzyme Q-10 (Ubiquinone) 200mg	**

\*\* Daily Value (DV) not established.  
Inactive Ingredients: Cellulose (Vegetable Capsule), Rice Flour.

www.drsoous.com  
Dr. Sous  
www.drsoous.ca

### 3. Magnesium Glycinate

Magnesium glycinate has gained attention as a potential supplement for managing type 2 diabetes. Type 2 diabetes is a chronic condition characterized by insulin resistance and high blood sugar levels. Magnesium is an essential mineral that plays a crucial role in various bodily functions, including glucose metabolism. Research suggests that magnesium glycinate, a form of magnesium that is highly absorbable, may have beneficial effects on glycemic control in individuals with type 2 diabetes. Magnesium glycinate supplementation has been shown to improve insulin sensitivity, enhance glucose uptake by cells, and reduce insulin resistance. Additionally, it may contribute to better blood sugar control by promoting the production and release of insulin from the pancreas. Furthermore, magnesium glycinate has been found to have anti-inflammatory and antioxidant properties, which can help mitigate the complications associated with type 2 diabetes, such as cardiovascular disease. It is important to note that while magnesium glycinate shows promise in managing type 2 diabetes, it should not replace conventional treatments.

Magnesium Glycinate is one of the most important nutrients needed throughout the body. It is most commonly used as a natural sleep vitamin that helps calm the brain, to help the body relax and fall and stay asleep. By doing this the body is able to be rejuvenated

**Magnesium Glycinate**  
Magnesium Glycinate is one of the most important nutrients needed throughout the body. It is most commonly used as a natural sleep vitamin that helps calm the brain, to help the body relax and fall and stay asleep. By doing this the body is able to be rejuvenated.

www.drsoous.com  
Dr. Sous  
www.drsoous.ca

#### 4. High Protein Meal Replacement

A high protein meal replacement can be a beneficial option for individuals with type 2 diabetes. Type 2 diabetes is a chronic condition that affects the body's ability to regulate blood sugar levels effectively. Managing this condition often requires careful attention to diet and nutrition. Including a high protein meal replacement can help individuals with type 2 diabetes maintain stable blood sugar levels while also providing essential nutrients. Proteins are known to have a minimal impact on blood sugar levels compared to carbohydrates. By incorporating a high protein meal replacement into their diet, individuals with type 2 diabetes can reduce the risk of blood sugar spikes and maintain better control over their glucose levels. Additionally, protein is known to promote feelings of fullness and satiety, which can be helpful in managing weight and preventing overeating. This can be particularly important for individuals with type 2 diabetes, as maintaining a healthy weight is key to managing their condition effectively. Furthermore, high protein meal replacements often contain other essential nutrients such as vitamins, minerals, and fiber, which are crucial for overall health and well-being. These meal replacements offer a convenient and easy-to-follow option for individuals with type 2 diabetes, as they provide a well-balanced and controlled portion of nutrients. However, it is important for individuals to consult with a healthcare professional or a registered dietitian before incorporating any meal replacement into their diabetes management plan, as individual needs may vary.

Our High Protein Meal Replacement (vanilla) comprises the perfect balance of protein, carbs, and healthy fats, giving your body elevated levels of sustained energy for up to four full hours. Not only does this High Protein Meal Replacement powder taste fantastic (like a hand-dipped milkshake,) but it contains a healthy dose of fiber and digestive enzymes for maximum absorption.

**Ingredients:** see Supplement Facts

**Flavor:** Vanilla

**Manufacturer Country:** USA

**Product Amount:** 2.9lb (1.32kg)

**Gross Weight:** 3.3lb (1.5kg)

**DRSOUS.CA High Protein Meal Replacement (Vanilla)**  
Regular price: \$65.00 CAD  
Product Amount: 2.9lb (1.32kg)  
Gross Weight: 3.3lb (1.5kg)

A highly absorbable protein powder with seven kinds of protein plus enzymes and fiber.

- Releases protein for a full four hours
- Includes digestive enzymes for easy absorption
- Packed with 5 grams of Fiber per serving
- No added sugar

Supplement Facts	
Serving Size: 1 Scoop (30g)	
Amount Per Serving	
Total Protein	25g
Total Fat	8g
Total Carbohydrate	25g
Total Fiber	5g
Total Sugar	0g
Total Fat	8g
Total Carbohydrate	25g
Total Fiber	5g
Total Sugar	0g
Total Protein	25g
Total Fat	8g
Total Carbohydrate	25g
Total Fiber	5g
Total Sugar	0g

Paradise Wellness A specific channel for High Protein Meal Replacement on YouTube

Dr. Soos | www.drsoos.ca

#### 3. GESTATIONAL DIABETES

Gestational diabetes is a condition that affects women when they are pregnant. It can happen at any time during the pregnancy, and the condition will usually disappear after the mother has given birth. It most commonly starts during the second or third trimester. Gestation diabetes happens because the patient's body is unable to produce the volumes of insulin needed to meet the increased demand. It does not usually show symptoms and is usually only discovered by screening tests. The condition can often be managed, meaning it will pose little threat, but it can be dangerous to both mother and baby in some cases.

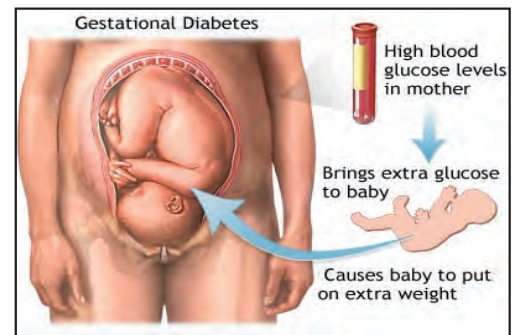

## # Symptoms

### 1. Hunger

It is healthy to eat plenty of food. Food provides us with the energy we need, the building blocks need for growth, maintenance and repair, and everything else that is required to keep our bodies functioning. While it is healthy for us to eat plenty of food, however, we should also be careful not to eat too much. One of the symptoms of gestational diabetes is that the patient is likely to feel hungry more often than usual. This will, in turn, compel them to eat more than they otherwise would. In addition to being a symptom of gestational diabetes, eating too much is also a potential cause of the condition.

### 2. Dry Mouth

Our mouths are naturally very moist. This is thanks to the presence of a fluid that we know as saliva, and the fluid is more important to us than a lot of people realize. For example, it helps to break down our food, softening it in readiness for digestion. The fluid also helps to prevent infections in the mouth due to its anti-septic properties. If the body was to stop producing and/or secreting saliva into our mouths, then our mouths would soon become dry. This can become quite uncomfortable and can also go on to cause a number of complications. A dry mouth is a symptom of gestational diabetes, and it is a symptom that you should get checked out if you develop it.

### 3. Thirst

Depending on their size and lifestyle, most people will need from between around 2.5 liters to 4 liters of fluids a day. Water is simply essential to us and we would only live for a few days without it. To help ensure we do get the water we need, we have developed a sensation that we know as thirst. Gestational diabetes can make people thirstier than they otherwise would be, and they can find that their thirst is not satiated even after they are drinking. This happens because your body wants you to take on more fluids to help flush out the excess glucose in your blood stream.

### 4. Urinating Frequently

When our bladders are full, they need to be emptied. This means that we will need to take several trips to the bathroom every day. How frequently we urinate will depend on several factors, including how many fluids we drink. Another factor is certain medical conditions, including gestational diabetes.

As mentioned, people with the condition will be taking in more fluids to try and flush out excess glucose from the blood. This means that the bladder will fill faster than it otherwise would and this, in turn, will mean that we need to make a visit to the bathroom more frequently.

### 1. Magnesium Glycinate

Magnesium Glycinate has been gaining attention as a potential treatment for gestational diabetes, a condition that affects pregnant women and can have serious implications for both the mother and the baby. Gestational diabetes is characterized by high blood sugar levels during pregnancy, and it can increase the risk of complications such as preterm birth, preeclampsia, and the development of type 2 diabetes later in life. Magnesium is an essential mineral that plays a crucial role in various bodily functions, including glucose metabolism and insulin production. It has been suggested that supplementing with magnesium glycinate during pregnancy may help regulate blood sugar levels and improve insulin sensitivity, thus potentially reducing the risk of gestational diabetes and its associated complications. Additionally, magnesium glycinate is known for its ability to promote relaxation and relieve muscle cramps, which are common discomforts experienced during pregnancy. This can contribute to overall well-being and enhance the quality of life for expectant mothers. Magnesium Glycinate is one of the most important nutrients needed throughout the body. It is most commonly used as a natural sleep vitamin that helps calm the brain, to help the body relax and fall and stay asleep. By doing this the body is able to be rejuvenated

**Magnesium Glycinate**

Magnesium Glycinate is one of the most important nutrients needed throughout the body. It is most commonly used as a natural sleep vitamin that helps calm the brain, to help the body relax and fall and stay asleep. By doing this the body is able to be rejuvenated

160

www.dr-south.com A specific channel for Supplements on YouTube

Dr. South



tional diabetes. Furthermore, resveratrol has been found to have a positive impact on lipid metabolism, potentially lowering the risk of dyslipidemia, a common complication of gestational diabetes.

Resveratrol is a plant compound with potent antioxidant functionality. Resveratrol is found mainly in red wine, red grapes, berries, and peanuts. It is most concentrated in the skin of grape skins and seeds.

Resveratrol has been linked to many exciting health benefits, such as lowering cholesterol, supporting brain health, and controlling weight loss. These, coupled with antioxidant abilities, make the perfect daily supplement.

**Ingredients:** see Supplement Facts.

**Manufacturer Country:** USA

**Product Amount:** 60 caps

**Gross Weight:** 0.25lb (113g)

**Suggested Use:** Take one (1) veggie capsule twice a day as a dietary supplement. For best results, take 20-30 min before a meal or as directed by your healthcare professional.

**DRSOUS.CA Resveratrol 50% 600mg Antioxidant**  
Regular price \$28.00 CAD  
Product Amount: 60 caps  
Gross Weight: 0.25lb (113g)  
Resveratrol is an antioxidant-like compound that promotes heart health, brain health and supports weight loss.

- Cardiovascular health
- Antioxidant
- Weight control
- Anti-aging

	Amount Per Serving	% Daily Value
Resveratrol (Polyphenol capsaicin) (50%) (Complex Containing 50% Trans-Resveratrol)	600mg	**

\*\* % Daily Value not established  
Other Ingredients: Vegetable Capsule (Cellulose), Microcrystalline Cellulose.

Paradise Wellness | Dr. Sows | www.drsoous.ca

#### 4. DIABETIC FOOT

Some people with diabetes develop numbness in the feet or poor blood flow. That can make it difficult to notice blisters, sores and cuts. Undetected and untreated wounds can quickly become infected, leading to complications and sometimes amputation.

##### What are diabetes-related foot conditions?

People with diabetes often have problems with their feet. They may develop foot develop sores, deformities and infections more easily. If not treated quickly, a foot ulcer or blister on a person with diabetes can get infected. Sometimes a surgeon must amputate (remove) a toe, foot or part of the leg to prevent the spread of infection.

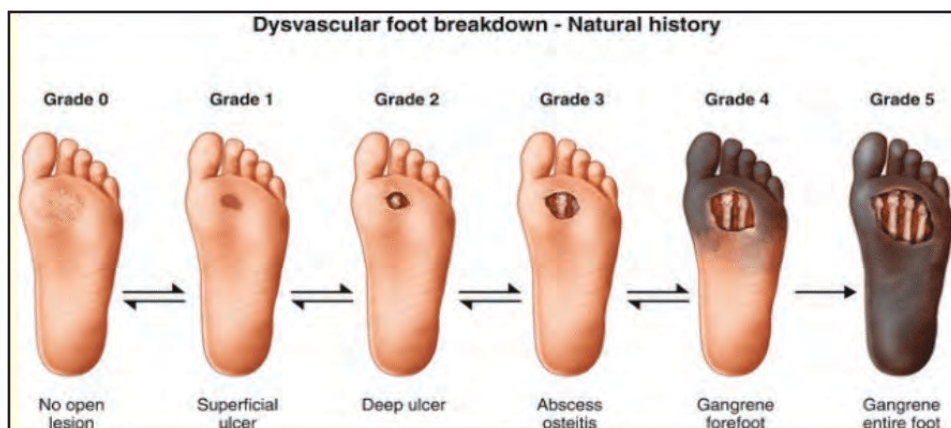

### Who might have problems with diabetes-related foot conditions?

Foot problems often occur in people with diabetes, especially among those who have:

- Nerve damage or poor blood flow in the feet.
- Trouble managing blood glucose levels over long periods, including frequent episodes of hyperglycemia (blood sugar that's too high).
- A BMI of more than 25 (overweight/obesity).
- Had diabetes for a long time.
- High blood pressure or high cholesterol.

### Tips for Proper Diabetic Foot Care

- Check your feet daily
- Clean and dress cuts and wounds immediately
- Wear properly fitting footwear
- Keep feet clean and dry
- Apply proper lotion to dry or cracked skin
- Consult with a chiropodists regularly

### When you have diabetic feet, there are some things you should avoid doing.

- Treating corns and calluses at home
- Treatment of nail problems at home
- Over-the-counter medications or home remedies for corns, ingrown nails or warts
- Tightly fitting hosiery
- Poor-fitting or worn-out footwear
- Extreme hot or cold temperatures

### What are the symptoms of diabetes-related neuropathy?

The signs of diabetes-related neuropathy may include:

- Darkened skin on the affected area.
- Diminished ability to sense hot or cold.
- Loss of hair in the area.
- Numbness.
- Pain.
- Tingling.

### If diabetes-related neuropathy leads to foot ulcers, symptoms to watch out for include:

- Any changes to the skin or toenails, including cuts, blisters, calluses or sores.
- Discharge of fluid or pus.
- Foul smell.
- Pain.
- Redness.
- Skin discoloration.
- Swelling.

**The most recommended supplements for diabetic foot are:** B-12 Drops, 5HTP, & CoQ10.

#### 1. B-12 Drops

B-12, also known as vitamin B12, has been a subject of interest and research in the context of diabetic foot. Diabetic foot is a common



complication of diabetes that can lead to serious consequences, including ulcers, infections, and in severe cases, amputation. Vitamin B12 plays a crucial role in maintaining the health of nerves, red blood cells, and DNA synthesis, making it an essential nutrient for overall bodily function. In the case of diabetic foot, B-12 supplementation has shown potential benefits. Diabetic individuals often experience neuropathy, a condition characterized by nerve damage, which can lead to loss of sensation in the feet. Vitamin B12 has been found to have a positive impact on nerve health and function, potentially alleviating some of the symptoms associated with diabetic neuropathy. Additionally, B-12 supplementation may help improve wound healing, a critical factor in the management of diabetic foot ulcers. Studies have shown that vitamin B12 deficiency is common among individuals with diabetes, and correcting this deficiency through supplementation can have positive effects on nerve regeneration and wound healing.

B12 complex contains: Riboflavin-required for the proper development and function of the skin, lining of the digestive tract, Niacin-required for the proper function of fats and sugars in the body and to maintain healthy tissue, Vitamin B6-needed to maintain proper energy levels. B12 is a critical vitamin that is required for proper development of many body systems and tissues. Deficiency of B12 can lead to many problems such as memory loss and fatigue.

157

**B-12 Drops**

B12 complex contains: Riboflavin-required for the proper development and function of the skin, lining of the digestive tract, Niacin-required for the proper function of fats and sugars in the body and to maintain healthy tissue, Vitamin B6-needed to maintain proper energy levels. B12 is a critical vitamin that is required for proper development of many body systems and tissues. Deficiency of B12 can lead to many problems such as memory loss and fatigue.

A specific channel for b-12 Drops on YouTube

Dr. Soms

www.drSous.ca

## 2. 5HTP

5HTP, also known as 5-Hydroxytryptophan, is a naturally occurring amino acid that is often used as a dietary supplement. It is derived from the seeds of the Griffonia simplicifolia plant and is known for its potential health benefits. One area where 5HTP has shown promise is in the management of diabetic foot. Diabetic foot is a common complication of diabetes that can lead to serious infections, ulcers, and even amputations if not properly treated. Research suggests that 5HTP may play a role in improving symptoms related to diabetic foot. One study conducted on diabetic rats found that treatment with 5HTP reduced inflammation and improved wound healing. Another study involving diabetic patients showed that 5HTP supplementation resulted in a significant decrease in pain and an improvement in sensory symptoms associated with diabetic foot. These findings suggest that 5HTP may have a potential therapeutic effect in managing diabetic foot.

5-HTP dietary supplements also aid in increasing serotonin levels in the brain, significantly affecting mood and behavior. Because serotonin regulates mood and behavior, 5-HTP may improve:

- Sleep
- Mood
- Anxiety
- Hunger
- Pain sensitivity

Since 5-HTP is naturally present in the body, supplementing with it is a clean, holistic way to increase serotonin levels.

**Ingredients:** see Supplement Facts.

**Manufacturer Country:** USA

**Product Amount:** 60 caps

**Gross Weight:** 0.25lb (113g)

**Suggested Use:** Take two (2) capsules once a day as a dietary supplement. For best results, take 20-30 min before a meal with an 8oz glass of water or as directed by your healthcare professional.

**DrSous.Ca 5-HTP Dietary Supplement 60 Capsules**  
Leep Mood Anxiety Hunger Increase Serotonin  
Regular price: \$28.00 CAD  
Product Amount: 60 capsules  
Gross Weight: 0.25lb (113g)  
Keto 5 is a combination of raspberry ketones, green tea extract, coffee beans, and Garcinia Cambogia that delivers a potent fat-burning effect to the body.  
• Healthy weight control  
• Boosts Ketosis to help burn fat  
• Boosts metabolism  
• Improves focus and awareness

Supplement Facts	
Serving Size: 1 Capsule	Servings Per Container: 60
Amount Per Serving %DV	
5-HTP	100% **

Paradise Wellness | Dr. Sous | www.drsous.ca

### 3. CoQ10

CoQ10, also known as coenzyme Q10, is an essential compound that plays a crucial role in the body's energy production and antioxidant defense. While it is widely recognized for its benefits in cardiovascular health and aging, recent research has shown promising effects of CoQ10 in managing diabetic foot complications. Diabetic foot is a common and serious complication of diabetes, characterized by a range of issues such as ulcers, infections, and poor wound healing. Studies have suggested that CoQ10 supplementation may help improve the outcomes of diabetic foot by promoting wound healing, reducing inflammation, and enhancing antioxidant activity. CoQ10's ability to enhance mitochondrial function and energy production can support the healing process of diabetic foot ulcers, which are often slow to heal due to impaired blood flow and reduced oxygen supply. Furthermore, CoQ10's antioxidant properties can help counteract the oxidative stress that contributes to tissue damage and impaired wound healing in diabetic foot. By reducing inflammation and oxidative damage, CoQ10 may also help prevent and control infections in diabetic foot, which can lead to serious complications if left untreated.

**Ingredients:** see Supplement Facts.

**Manufacturer Country:** USA

**Product Amount:** 30 caps

**Gross Weight:** 0.25lb (113g)

**Suggested Use:** Take one (1) capsule twice a day as a dietary supplement. For best results, take 20-30 min before a meal or as directed by your healthcare professional.

**Caution:** Do not exceed recommended dose. Pregnant or nursing mothers, children under the age of 18, and individuals with a known medical condition should consult a physician before using this or any dietary supplement.

**Warning:** Keep out of reach of children. Do not use if the safety seal is damaged or missing. Store in a cool, dry place.

The Food and Drug Administration has not evaluated these statements. This product is not intended to diagnose, treat, cure or prevent any disease.

**DRSOUS.CA CoQ10 Ubiquinone energy production source supplement 30 Capsules**  
Regular price: \$24.00 CAD  
Amount: 30 caps  
Gross Weight: 0.25lb (113g)  
Coenzyme Q10 (CoQ10) is an antioxidant and vitamin-like compound that is found naturally in the body and in some foods like oily fish (salmon and tuna) and organ meats (liver).

Supplement Facts	
Serving Size: 1 Capsule	Servings Per Container: 30
Amount Per Serving %DV	
Coenzyme Q-10 (Ubiquinone)	200mg **

Paradise Wellness | Dr. Sous | www.drsous.ca

## 5. DIABETIC RETINOPATHY

Diabetic retinopathy is a diabetes complication that affects eyes. It's caused by damage to the blood vessels of the light-sensitive tissue at the back of the eye (retina). At first, diabetic retinopathy might cause no symptoms or only mild vision problems. But it can lead to blindness.

The condition can develop in anyone who has type 1 or type 2 diabetes. The longer you have diabetes and the less controlled your blood sugar is, the more likely you are to develop this eye complication.

### #Symptoms

You might not have symptoms in the early stages of diabetic retinopathy. As the condition progresses, you might develop:

- Spots or dark strings floating in your vision (floaters)
- Blurred vision
- Fluctuating vision
- Dark or empty areas in your vision
- Vision loss

### Causes

Over time, too much sugar in your blood can lead to the blockage of the tiny blood vessels that nourish the retina, cutting off its blood supply. As a result, the eye attempts to grow new blood vessels. But these new blood vessels don't develop properly and can leak easily.

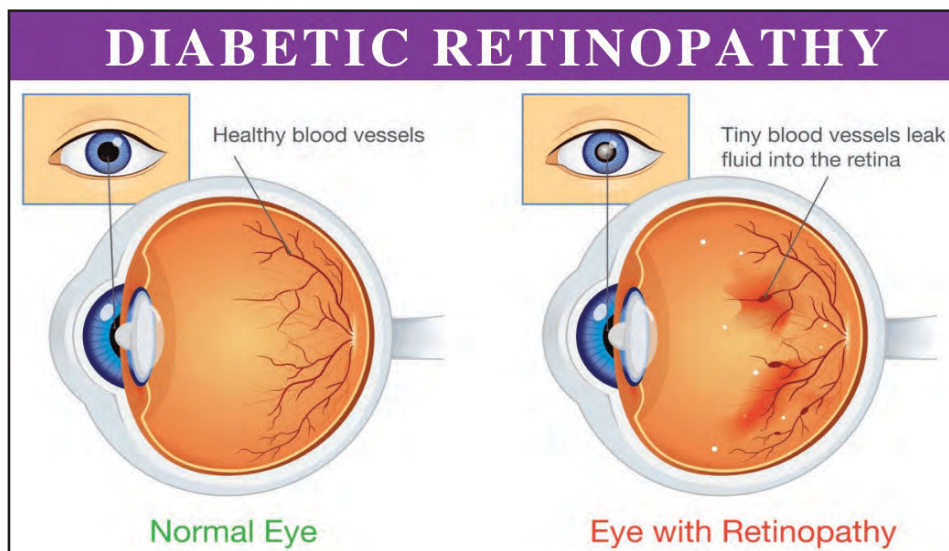

There are two types of diabetic retinopathy:

**Early diabetic retinopathy.** In this more common form called non-proliferative diabetic retinopathy (NPDR) new blood vessels aren't growing (proliferating).

When you have non-proliferative diabetic retinopathy (NPDR), the walls of the blood vessels in your retina weaken. Tiny bulges protrude from the walls of the smaller vessels, sometimes leaking fluid and blood into the retina. Larger retinal vessels can begin to dilate and become irregular in diameter as well. NPDR can progress from mild to severe as more blood vessels become blocked.

Sometimes retinal blood vessel damage leads to a buildup of fluid (edema) in the center portion (macula) of the retina. If macular edema decreases vision, treatment is required to prevent permanent vision loss.

**Advanced diabetic retinopathy.** Diabetic retinopathy can progress to this more severe type, known as proliferative diabetic retinopathy. In this type, damaged blood vessels close off, causing the growth of new, abnormal blood vessels in the retina. These new blood

vessels are fragile and can leak into the clear, jellylike substance that fills the center of your eye (vitreous). Eventually, scar tissue from the growth of new blood vessels can cause the retina to detach from the back of your eye. If the new blood vessels interfere with the normal flow of fluid out of the eye, pressure can build in the eyeball. This buildup can damage the nerve that carries images from your eye to your brain (optic nerve), resulting in glaucoma.

### **Prevention**

You can't always prevent diabetic retinopathy. However, regular eye exams, good control of your blood sugar and blood pressure, and early intervention for vision problems can help prevent severe vision loss.

If you have diabetes, reduce your risk of getting diabetic retinopathy by doing the following:

**Manage your diabetes.** Make healthy eating and physical activity part of your daily routine. Try to get at least 150 minutes of moderate aerobic activity, such as walking, each week. Take oral diabetes medications or insulin as directed.

**Monitor your blood sugar level.** You might need to check and record your blood sugar level several times a day or more frequently if you're ill or under stress. Ask your doctor how often you need to test your blood sugar.

**Ask your doctor about a glycosylated hemoglobin test.** The glycosylated hemoglobin test, or hemoglobin A1C test, reflects your average blood sugar level for the two- to three-month period before the test. For most people with diabetes, the A1C goal is to be under 7%.

**Keep your blood pressure and cholesterol under control.** Eating healthy foods, exercising regularly and losing excess weight can help. Sometimes medication is needed, too.

**If you smoke or use other types of tobacco,** ask your doctor to help you quit. Smoking increases your risk of various diabetes complications, including diabetic retinopathy.

**Pay attention to vision changes.** Contact your eye doctor right away if your vision suddenly changes or becomes blurry, spotty or hazy.

**The most recommended supplements for Diabetic retinopathy are:** CoQ10, Magnesium Glycinate, & Vitamin C.

#### **1. CoQ10**

Coenzyme Q10 (CoQ10) has gained significant attention in recent years as a potential therapeutic agent for various health conditions, including diabetic retinopathy. Diabetic retinopathy is a common complication of diabetes that affects the blood vessels in the retina, leading to vision impairment or even blindness. CoQ10, a naturally occurring antioxidant in the human body, plays a crucial role in cellular energy production and protection against oxidative stress. Several studies have suggested that CoQ10 supplementation may have beneficial effects on diabetic retinopathy by reducing oxidative stress, inflammation, and vascular dysfunction. CoQ10's antioxidant properties help neutralize harmful free radicals and protect retinal cells from damage. Additionally, CoQ10's ability to improve mitochondrial function and enhance energy production may contribute to the maintenance of retinal health.

**Ingredients:** see Supplement Facts.

**Manufacturer Country:** USA

**Product Amount:** 30 caps

**Gross Weight:** 0.25lb (113g)

**Suggested Use:** Take one (1) capsule twice a day as a dietary supplement. For best results, take 20-30 min before a meal or as directed by your healthcare professional.

**Caution:** Do not exceed recommended dose. Pregnant or nursing mothers, children under the age of 18, and individuals with a known medical condition should consult a physician before using this or any dietary supplement.

**Warning:** Keep out of reach of children. Do not use if the safety seal is damaged or missing. Store in a cool, dry place.

The Food and Drug Administration has not evaluated these statements. This product is not intended to diagnose, treat, cure or prevent any disease.

**DRSOUS.CA CoQ10 Ubiquinone energy production source supplement 30 Capsules**  
Regular price: \$24.00 CAD  
Amount: 30 caps  
Gross Weight: 0.25lb (113g)  
Coenzyme Q10 (CoQ10) is an antioxidant and vitamin-like compound that is found naturally in the body and in some foods like oily fish (salmon and tuna) and organ meats (liver).

Amount Per Serving	%DV
Coenzyme Q-10 (Ubiquinone) 200mg	**
** Daily Value (DV) not established	

Inactive Ingredients: Cellulose (Vegetable Capsule), Rice Flour.

113

A specific channel for COQ10 on YouTube

www.paradisewellness.ca | Dr. Sous | www.drsous.ca

## 2. Magnesium Glycinate

Magnesium is an essential mineral that plays a crucial role in various bodily functions, including nerve transmission, muscle contraction, and maintaining a healthy cardiovascular system. Glycine, an amino acid, enhances the absorption and bioavailability of magnesium in the body. Studies have suggested that magnesium supplementation, particularly in the form of Magnesium Glycinate, may have positive effects on diabetic retinopathy by improving blood flow, reducing inflammation, and protecting against oxidative stress. Magnesium Glycinate's ability to enhance insulin sensitivity and regulate blood sugar levels may also contribute to its potential benefits in managing diabetic retinopathy.

**Magnesium Glycinate**

Magnesium Glycinate is one of the most important nutrients needed throughout the body. It is most commonly used as a natural sleep stimulant that helps calm the brain, to help the body relax and fall and stay asleep. By doing this the body is able to be rejuvenated.

160

www.paradisewellness.ca | A specific channel for Supplements on YouTube | Dr. Sous | www.drsous.ca

## 3. Vitamin C

Vitamin C is a powerful antioxidant that helps to neutralize harmful free radicals in the body, which can contribute to the development of complications associated with diabetes. By reducing oxidative stress and inflammation in the retina, vitamin C may help to preserve the integrity of the blood vessels and prevent the damage that can lead to diabetic retinopathy. Additionally, vitamin C plays a crucial role in collagen synthesis, which is essential for maintaining the structure and function of the blood vessels. By supporting the production of collagen, vitamin C may help to strengthen the blood vessels in the retina and reduce the risk of leakage or bleeding. While more research is needed to fully understand the effects of vitamin C on diabetic retinopathy, early studies have shown promising results. In one clinical trial, patients with diabetic retinopathy who received high-dose vitamin C supplementation experienced improvements in their retinal function and a reduction in retinal thickness. These findings suggest that vitamin C may have a beneficial effect on the progression of diabetic retinopathy and could potentially be used as a complementary therapy alongside existing treatments.

**Ingredients:** Vitamin C (as Ascorbic Acid), Glucose Syrup, Sugar, Glucose, Apple Juice (from concentrate), Pectin, Citric Acid, Sodium Citrate, Natural Strawberry flavor, Radish Red.

**Manufacturer Country:** USA

**Product Amount:** 60 gummies

**Gross Weight:** 0.37lb (170g)

**Suggested Use:** Take two (2) gummies a day as a dietary supplement.

**Caution:** Do not exceed recommended dose. Pregnant or nursing mothers, children under the age of 18, and individuals with a known medical condition should consult a physician before using this or any dietary supplement.

**DrSous.Ca Vitamin C Gummies**  
Regular price: \$12.55 CAD  
Product Amount: 60 gummies  
Gross Weight: 0.37lb (170g)  
Vitamin C Gummies are an effective way to get the necessary daily Vitamin C for your body. They provide you with the daily Vitamin C that your body needs to fight off free radicals, lower blood pressure, lower the risk of heart disease and boost the immune system against infection overall.

	Amount Per Serving	%DV*
Calories	12	
Calories from Fat	0	1%
Total Carbohydrates	3g	4%
Sugar	2g	4%
Vitamin C (as Ascorbic Acid)	60mg	67%

\*The % Daily Value (%DV) lets you know how much a nutrient in a serving of food contributes to a daily diet. 2,000 calories a day is used for general nutrition advice.

153

A specific claim for Vitamin C on YouTube

Paradise Wellness | Dr. Sous | www.drsous.ca

## 6. ACUTE AND CHRONIC PANCREATITIS

The pancreas is essential to digestion. It is often overlooked because it cannot be viewed properly without surgery. This is part and parcel of pancreatic issues and the reason for the high death rates stemming from its malfunction. Pancreatitis is the sudden inflammation of the organ and may be either chronic or acute. Neither is more or less serious than the other. However, acute pancreatitis is more difficult for a physician to diagnose owing to the quick nature in which it develops. It often goes untreated and is often fatal. Almost without exception, acute pancreatitis announces itself with the onset of pain in the upper abdomen, just beneath the breastbone or sternum. The pain may come on quickly and tends to become a constant, almost unbearable ache within hours. If you find yourself curling into a fetal position for relief, you need a doctor. The gallbladder can be involved in pancreatitis. The pear-shaped organ lies beneath your liver, in the upper-right of the abdomen. It stores bile, fat, cholesterol, and fluids and aids in digestion. Without this bile, digestion is nearly impossible, and absorption of your stomach contents is difficult. Problems in the gallbladder can lead to gallstones.

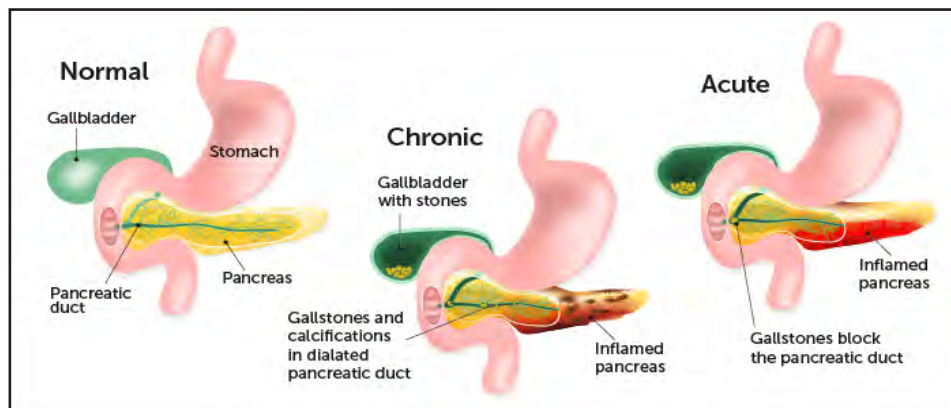

### # Symptoms

#### Abdominal Pain

The primary symptoms of pancreatitis is abdominal pain. Abdominal pain is a common symptom for both acute and chronic pancre-

atitis. In both cases, the pain occurs in the upper middle (epigastric region) and left side of the abdomen. The pain may reach the left shoulder blade and spread downwards into the lower back. Stomach pain associated with pancreatitis can be different from ordinary stomach-ache because pancreatic abdominal pain persists and worsens for several days without treatment. The pain is usually worse after a meal and when you lie down flat. However, getting into certain positions (i.e. fetal position) may provide some relief. If you experience abdominal pain that won't go away, it is recommended that you seek medical attention.

### **Swollen Abdomen**

Patients with pancreatitis can experience abdominal distension along with abdominal pain and/or abdominal tenderness. Note that there are several other common causes of abdominal distension such as bowel distension, ascites, ileus, and more. If you experience severe abdominal pain with abdominal distension do not hesitate to consult with your physician.

### **Weight Loss**

Even though a lot of people would like to lose some weight, it does not always happen on purpose. Especially in chronic pancreatitis, patients can experience weight loss. Significant weight loss that happens without any effort on your part could be a sign of a chronic pathologic process like chronic pancreatitis.

Besides the loss of weight, patients with pancreatitis can also develop poor appetite, and vomiting.

### **Fever**

Fever is considered any body temperature above 100.4 F (38 C°). It may also be accompanied by shivering and headache. Patients with pancreatitis commonly present with fever. Moreover, approximately 76 percent of patients with acute pancreatitis report fever.

Remember that the sensation of warmth and discomfort associated with an elevation of body temperature is subjective and does not constitute accurate information about your condition when reporting it to your physician. Before reporting "fever" to your physician, remember to take your temperature with the use of a thermometer.

### **Additional symptoms of acute pancreatitis may include:**

- Nausea and vomiting.
- Fast heart rate.
- Fast, shallow breathing.
- Fever.

### **Additional symptoms of chronic pancreatitis may include:**

- Indigestion and pain after eating.
- Loss of appetite and unintended weight loss.
- Fatty poops that leave an oily film in the toilet.
- Light-headedness (low blood pressure).

**The recommended supplements for pancreatitis are:** Digestive Enzyme, Probiotics, Platinum Turmeric & Vitamin C.

### **1. Digestive Enzyme**

Pancreatitis is a medical condition characterized by inflammation of the pancreas, a vital organ responsible for producing digestive enzymes. However, in cases of pancreatitis, the enzymes are activated prematurely within the pancreas, leading to damage and inflammation. As a result, individuals with pancreatitis may experience symptoms such as abdominal pain, nausea, vomiting, and weight loss. To alleviate these symptoms and aid in the healing process, digestive enzymes are often prescribed as a treatment option. Digestive enzymes, such as amylase, lipase, and protease, play a crucial role in breaking down food into smaller molecules that can be absorbed by the body. By taking supplemental digestive enzymes, individuals with pancreatitis can give their pancreas a break and help ease the burden on the organ. These enzymes assist in the breakdown of carbohydrates, fats, and proteins, ensuring that the body can properly





**Product Amount:** 60 caps

**Gross Weight:** 0.25lb (113g)

**Suggested Use:** Take two (2) capsules once a day as a dietary supplement. For best results, take one (1) capsule during the day and one (1) capsule in the evening. Repeat the process daily. Do not exceed two capsules per day.

**Warning:** Keep out of reach of children. Do not use if the safety seal is damaged or missing. Store in a cool, dry place.

The Food and Drug Administration has not evaluated these statements. This product is not intended to diagnose, treat, cure or prevent any disease.

**DrSous.Ca Probiotic 40 Billion with Prebiotics**  
Regular price: \$27.00 CAD  
Product Amount: 60 caps  
Gross Weight: 0.25lb (113g)

Probiotic 40 Billion with Prebiotics is a blend of four probiotic strains: *Lactobacillus Acidophilus*, *Bifidobacterium Lactis*, *Lactobacillus Plantarum*, and *Lactobacillus Paracasei*. Together, they provide a high level of beneficial bacteria to the gut to support a healthy metabolic response for both men and women.

**Supplement Facts**  
Serving Size: 2 Capsules  
Servings Per Container: 30

	Amount Per Serving	%DV
Proprietary Blend of Probiotic Bacteria	40 Billion CFU	
Each CFU from Fermenting		
<i>Lactobacillus Acidophilus</i>	1.25B	
<i>Bifidobacterium Lactis</i>	200M	
<i>Lactobacillus Plantarum</i>	1.25B	
<i>Lactobacillus Paracasei</i>	500M	
Marine Polysaccharide Complex		
Fructooligosaccharide		

Paradise Wellness  
A specific channel for Probiotic 40 on YouTube

Dr. Sous  
www.drsous.ca

### 3. Platinum Turmeric

Platinum Turmeric has gained significant attention as a potential remedy for pancreatitis, a condition characterized by inflammation of the pancreas. Pancreatitis can cause debilitating symptoms such as abdominal pain, nausea, vomiting, and digestive issues, making it crucial to find effective treatments. Turmeric, a vibrant yellow spice commonly used in Indian cuisine, contains a compound called curcumin, which exhibits potent anti-inflammatory and antioxidant properties. These properties make curcumin a promising candidate for managing pancreatitis as it can help reduce inflammation and oxidative stress in the pancreas. Platinum Turmeric, a high-quality supplement, offers a concentrated form of curcumin, ensuring maximum potency and efficacy. By incorporating Platinum Turmeric into a pancreatitis management plan, individuals may potentially experience reduced pain and inflammation, improved digestion, and overall better pancreatic health. However, it is important to note that while Platinum Turmeric shows promise, it should not replace conventional medical treatments. It is always recommended to consult with a healthcare professional before incorporating any supplements into a treatment regimen. Platinum Turmeric serves as a complementary approach to managing pancreatitis, offering individuals a natural and potentially beneficial option to alleviate symptoms and support overall pancreatic health.

Our Platinum Turmeric blend contains various forms of turmeric, glucosamine, Boswellia extract (frankincense), piperine, and several other highly beneficial natural extracts to keep you at your best.

Natural extracts have been used for centuries in Ayurvedic medicine to remedy illnesses. We harness and advance these natural extracts in modern times for optimal bioavailability and effectiveness.

**Ingredients:** see Supplement Facts.

**Manufacturer Country:** USA

**Product Amount:** 60 caps

**Gross Weight:** 0.25lb (113g)

**Suggested Use:** Take two (2) capsules once a day as a dietary supplement. For best results, take 20-30 min before a meal or as directed by your healthcare professional.

**DrSous.Ca Platinum Turmeric 60 Capsule Bottle**  
Regular price: \$20.00 CAD  
Product Amount: 60 caps  
Gross Weight: 0.25lb (113g)

Our Platinum Turmeric blend contains various forms of turmeric, glucosamine, Boswellia extract (frankincense), piperine, and several other highly beneficial natural extracts to keep you at your best.

- Anti-inflammatory
- Joint and bone health
- Heart Protective
- Anti-oxidant & Anti-Cancer

**Supplement Facts**  
Serving Size: 2 Capsules  
Servings Per Container: 30

	Amount Per Serving	%DV
Proprietary Blend of Platinum Turmeric	600mg	
Glucosamine HCl	500mg	
Boswellia Extract	100mg	
Piperine	50mg	
Curcumin	100mg	
Black Pepper	50mg	
Garlic	50mg	
Green Tea	50mg	
Resveratrol	50mg	
Omega-3	50mg	
CoQ10	50mg	
Vitamin E	50mg	
Vitamin C	50mg	
Vitamin B12	50mcg	
Vitamin D3	500IU	
Zinc	50mg	
Magnesium	50mg	
Calcium	50mg	
Iron	50mg	
Copper	50mg	
Selenium	50mcg	
Manganese	50mg	
Chromium	50mcg	
Molybdenum	50mcg	
Iodine	50mcg	
Phosphorus	50mg	
Potassium	50mg	
Sodium	50mg	
Water	50mg	

Paradise Wellness  
A specific channel for Platinum Turmeric on YouTube

Dr. Sous  
www.drsous.ca

#### 4. Vitamin C

Pancreatitis is a condition characterized by inflammation of the pancreas, which can lead to severe abdominal pain, digestive problems, and potentially life-threatening complications. While there is no specific cure for pancreatitis, various treatment approaches aim to manage symptoms and promote healing. In recent years, Vitamin C has gained attention for its potential therapeutic benefits in the management of pancreatitis. Vitamin C is an essential nutrient that plays a crucial role in collagen synthesis, immune function, and antioxidant defense. Studies have suggested that Vitamin C supplementation may help reduce oxidative stress and inflammation in the pancreas, which are key factors in the development and progression of pancreatitis. Furthermore, Vitamin C has been shown to enhance the effectiveness of certain medications used in the treatment of pancreatitis, such as antioxidants and anti-inflammatory drugs. However, it is important to note that while Vitamin C may have potential benefits in the management of pancreatitis, it should not be considered a standalone treatment. It should be used as part of a comprehensive treatment plan prescribed by a healthcare professional. Our Vitamin C Gummies are a healthy, on-the-go snack for the whole family. They provide you with the daily Vitamin C that your body needs to fight off free radicals, lower blood pressure, lower the risk of heart disease and boost the immune system against infection overall.

**Ingredients:** Vitamin C (as Ascorbic Acid), Glucose Syrup, Sugar, Glucose, Apple Juice (from concentrate), Pectin, Citric Acid, Sodium Citrate, Natural Strawberry flavor, Radish Red.

**Manufacturer Country:** USA

**Product Amount:** 60 gummies

**Gross Weight:** 0.37lb (170g)

**Suggested Use:** Take two (2) capsules once a day as a dietary supplement.

**Caution:** Do not exceed recommended dose. Pregnant or nursing mothers, children under the age of 18, and individuals with a known medical condition should consult a physician before using this or any dietary supplement.



#### 7. PANCREATIC CYSTS

Pancreatic cysts are saclike pockets of fluid on or in your pancreas. The pancreas is a large organ behind the stomach that produces hormones and enzymes that help digest food.

Pancreatic cysts are saclike pockets of fluid on or in your pancreas. The pancreas is a large organ behind the stomach that produces hormones and enzymes that help digest food. Pancreatic cysts are typically found during imaging testing for another problem.

##### Types of Pancreatic Cysts

The main categories of pancreatic cysts can be divided into two groups, non-neoplastic or neoplastic cysts. Each group includes many different subtypes of cysts, such as pseudocysts, serous cystadenomas and mucinous cystic neoplasms. Most aren't cancerous, and many don't cause symptoms. But some pancreatic cysts can be or can become cancerous.

Your doctor might take a sample of the pancreatic cyst fluid to determine if cancer cells are present. Or your doctor might recommend monitoring a cyst over time for changes that indicate cancer.

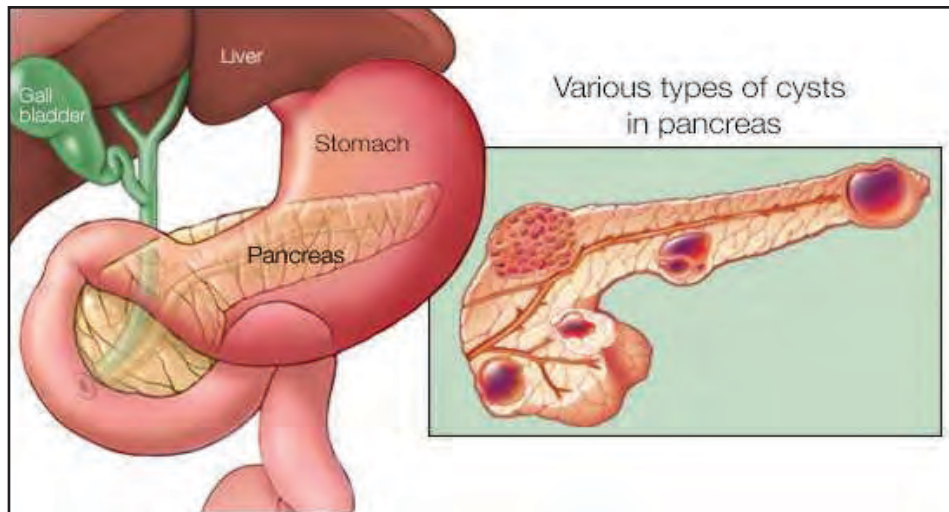

### # Symptoms

You may not have symptoms from pancreatic cysts, which are often found when imaging tests of the abdomen are done for another reason.

**When signs or symptoms of pancreatic cysts do occur, they typically include:**

- Persistent abdominal pain, which may radiate to your back
- Nausea and vomiting
- Weight loss
- Feeling Full soon after you start eating

**The most recommended supplements for pancreatic cysts are:** Platinum Turmeric, Vitamin C, & Resveratrol.

### 1. Platinum Turmeric

Platinum Turmeric, an innovative supplement, has gained significant attention in recent years for its potential benefits in managing pancreatic cysts. Pancreatic cysts are fluid-filled sacs that develop on or within the pancreas, and they can range from benign to precancerous or cancerous. While there is ongoing research on potential treatments for pancreatic cysts, Platinum Turmeric has emerged as a promising natural remedy. The key ingredient in this supplement is turmeric, a vibrant yellow spice that has been used for centuries in traditional medicine. Turmeric contains a compound called curcumin, which possesses potent anti-inflammatory and antioxidant properties. These properties make curcumin an excellent candidate for managing pancreatic cysts by reducing inflammation and oxidative stress within the pancreas. Additionally, curcumin has been found to inhibit the growth and proliferation of cancer cells, suggesting its potential in preventing the progression of precancerous cysts. Platinum Turmeric combines the benefits of curcumin with other carefully selected ingredients to enhance its efficacy. This supplement is formulated to ensure maximum bioavailability, allowing the body to absorb and utilize the active compounds effectively. Furthermore, Platinum Turmeric is manufactured using high-quality standards and undergoes rigorous testing to ensure its safety and purity. However, it is important to note that Platinum Turmeric should not be used as a substitute for medical advice or prescribed treatments. Individuals with pancreatic cysts or any other medical condition should consult with their healthcare provider before incorporating Platinum Turmeric into their regimen.

**Ingredients:** see Supplement Facts.

**Manufacturer Country:** USA

**Product Amount:** 60 caps

**Gross Weight:** 0.25lb (113g)

**Suggested Use:** Take two (2) capsules once a day as a dietary supplement. For best results, take 20-30 min before a meal or as directed by your healthcare professional.

**DrSous.Ca Platinum Turmeric 60**  
**Capsule Bottle**  
Regular price: \$20.00 CAD  
Product Amount: 60 caps  
Gross Weight: 0.25lb (113g)  
Our Platinum Turmeric blend contains various forms of turmeric, glucosamine, Boswellia extract (frankincense), piperine, and several other highly beneficial natural extracts to keep you at your best.

- Anti-inflammatory
- Joint and bone health
- Heart Protective
- Anti-oxidant & Anti- Cancer

**Supplement Facts**  
Serving Size: 2 Capsules  
Servings Per Container: 30

Amount Per Serving		%DV*
Glucosamine HCL (Type II)	500mg	100%
Curcumin (Type I)	500mg	100%
Curcumin (Type II)	500mg	100%
Curcumin (Type III)	500mg	100%
Curcumin (Type IV)	500mg	100%
Curcumin (Type V)	500mg	100%
Curcumin (Type VI)	500mg	100%
Curcumin (Type VII)	500mg	100%
Curcumin (Type VIII)	500mg	100%
Curcumin (Type IX)	500mg	100%
Curcumin (Type X)	500mg	100%
Curcumin (Type XI)	500mg	100%
Curcumin (Type XII)	500mg	100%
Curcumin (Type XIII)	500mg	100%
Curcumin (Type XIV)	500mg	100%
Curcumin (Type XV)	500mg	100%
Curcumin (Type XVI)	500mg	100%
Curcumin (Type XVII)	500mg	100%
Curcumin (Type XVIII)	500mg	100%
Curcumin (Type XIX)	500mg	100%
Curcumin (Type XX)	500mg	100%
Curcumin (Type XXI)	500mg	100%
Curcumin (Type XXII)	500mg	100%
Curcumin (Type XXIII)	500mg	100%
Curcumin (Type XXIV)	500mg	100%
Curcumin (Type XXV)	500mg	100%
Curcumin (Type XXVI)	500mg	100%
Curcumin (Type XXVII)	500mg	100%
Curcumin (Type XXVIII)	500mg	100%
Curcumin (Type XXIX)	500mg	100%
Curcumin (Type XXX)	500mg	100%

\*The % Daily Value (DV) is not established.

Other ingredients include: Hydroxypropyl Cellulose, Hydroxypropyl Methylcellulose, Hydroxypropyl Guar Gum, Hydroxypropyl Pectin, Hydroxypropyl Starch, Hydroxypropyl Cellulose, Hydroxypropyl Methylcellulose, Hydroxypropyl Guar Gum, Hydroxypropyl Pectin, Hydroxypropyl Starch, Hydroxypropyl Cellulose, Hydroxypropyl Methylcellulose, Hydroxypropyl Guar Gum, Hydroxypropyl Pectin, Hydroxypropyl Starch.

Dr. Sous | www.drsous.ca

## 2. Vitamin C

Vitamin C, also known as ascorbic acid, is a vital nutrient that plays a significant role in maintaining overall health and well-being. While its benefits are widely recognized, recent studies have shed light on the potential role of vitamin C in the management of pancreatic cysts. Pancreatic cysts are fluid-filled sacs that develop within the pancreas, and they can range from benign to precancerous or cancerous. As a potent antioxidant, vitamin C has been found to have anti-inflammatory properties and the ability to scavenge harmful free radicals within the body. This suggests that it may have a protective effect against the development and progression of pancreatic cysts. Furthermore, vitamin C has been shown to enhance the immune system's function, which is crucial for preventing and fighting off infections that may contribute to the formation of cysts. Additionally, studies have suggested that vitamin C may inhibit the growth of cancer cells, including those found in pancreatic cysts.

Our Vitamin C Gummies are a healthy, on-the-go snack for the whole family. They provide you with the daily Vitamin C that your body needs to fight off free radicals, lower blood pressure, lower the risk of heart disease and boost the immune system against infection overall.

**Ingredients:** Vitamin C (as Ascorbic Acid), Glucose Syrup, Sugar, Glucose, Apple Juice (from concentrate), Pectin, Citric Acid, Sodium Citrate, Natural Strawberry flavor, Radish Red.

**Manufacturer Country:** USA

**Product Amount:** 60 gummies

**Gross Weight:** 0.37lb (170g)

**Suggested Use:** Take two (2) capsules once a day as a dietary supplement.

**Caution:** Do not exceed recommended dose. Pregnant or nursing mothers, children under the age of 18, and individuals with a known medical condition should consult a physician before using this or any dietary supplement.

**DrSous.Ca Vitamin C Gummies**  
Regular price: \$12.85 CAD  
Product Amount: 60 gummies  
Gross Weight: 0.37lb (170g)  
Vitamin C Gummies are an effective way to get the necessary daily Vitamin C for your body. They provide you with the daily Vitamin C that your body needs to fight off free radicals, lower blood pressure, lower the risk of heart disease and boost the immune system against infection overall.

**Supplement Facts**  
Serving Size: 2 Gummies  
Servings Per Container: 30

Amount Per Serving		%DV*
Calories	12	
Calories from Fat	0	
Total Carbohydrates	3g	1%
Sugar	2g	4%
Vitamin C (as Ascorbic Acid)	60mg	67%

\*The % Daily Value (DV) tells you how much a nutrient in a serving of food contributes to a daily diet. 2,000 calories a day is used for general nutrition advice.

Dr. Sous | www.drsous.ca

### 3. Resveratrol

Resveratrol, a natural compound found in certain plants like grapes and berries, has been gaining attention for its potential role in managing pancreatic cysts. Pancreatic cysts are fluid-filled sacs that form in the pancreas, and while most of them are benign, some can progress to pancreatic cancer. Resveratrol has been studied for its various health benefits, including its anti-inflammatory and antioxidant properties. These properties are believed to help reduce inflammation and oxidative stress, two factors that contribute to the development and progression of pancreatic cysts. Additionally, resveratrol has been shown to inhibit the growth of cancer cells and induce cell death, which suggests its potential in preventing the malignant transformation of pancreatic cysts. While more research is needed to establish the efficacy and safety of resveratrol specifically for pancreatic cysts, preliminary studies and anecdotal evidence have shown promising results. Incorporating resveratrol-rich foods or supplements into one's diet may offer a natural and potentially beneficial approach to managing pancreatic cysts.

**Ingredients:** see Supplement Facts.

**Manufacturer Country:** USA

**Product Amount:** 60 caps

**Gross Weight:** 0.25lb (113g)

**Suggested Use:** Take one (1) veggie capsule twice a day as a dietary supplement. For best results, take 20-30 min before a meal or as directed by your healthcare professional.



### 8. PANCREATIC ENZYME DEFICIENCY DISORDER

Pancreatic Insufficiency (EPI) is a condition that occurs when the pancreas does not make enough of a specific enzyme the body uses to digest food in the small intestine. The pancreas is a glandular organ. That means the pancreas secretes juices that maintain the proper function of the body. The pancreas produces both enzymes and hormones. People with EPI don't have enough pancreatic (digestive) enzymes to break down foods and absorb nutrients. It can lead to malnutrition. Pancreatic enzyme replacement therapy (PERT) can help.

#### Enzymes and Hormones

Enzymes are catalysts that perform specific chemical functions in the body, such as breaking down foods, or synthesizing DNA. Enzymes control chemical reactions. The pancreas also secretes digestive enzymes which are released into the small intestine and play an important role in breaking down food products for absorption.

The different types of pancreatic enzymes include:

- Amylase, which breaks down carbohydrates.
- Lipase, which breaks down fats.
- Protease and elastase, which break down proteins.

Hormones are signaling chemicals that tell the body how to respond to a specific stimulus. The adrenal gland releases a hormone when

you are shocked or frightened. The islet cells of the pancreas secrete the hormones insulin and glucagon into the bloodstream. Insulin causes the body's cells to take up glucose from the blood; glucagon causes the liver to release glucose into the blood.

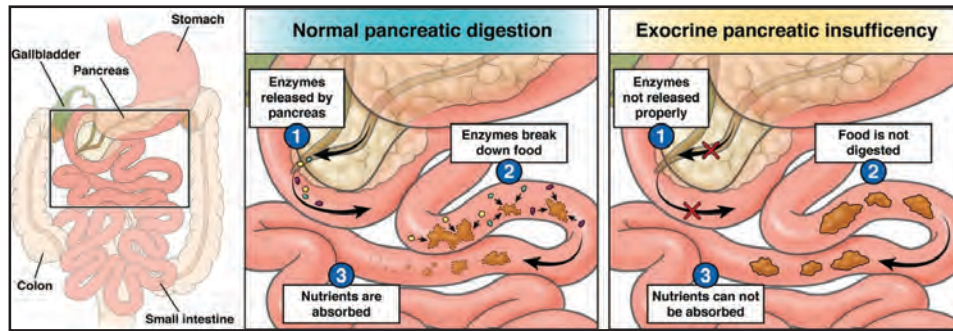

### What causes exocrine pancreatic insufficiency (EPI) in adults?

Chronic pancreatitis is the main cause of EPI in adults. As many as 8 in 10 adults with this disorder develop EPI. Pancreatitis causes inflammation and swelling of the pancreas. Over time, chronic inflammation can damage the pancreatic cells that make digestive enzymes.

### Other causes of EPI in adults include:

- Celiac disease.
- Diabetes.
- Inflammatory bowel disease (IBD).
- Pancreatic cancer.
- Surgery on the digestive tract, including weight loss surgery.
- Cystic fibrosis is the top cause of EPI in infants and children.

### # Symptoms

People with EPI have a particularly difficult time absorbing fats from foods. This leads to uncomfortable digestive problems, such as:

- Abdominal pain, gas and bloating.
- Constipation.
- Diarrhea.
- Fatty stools (pale, oily, foul-smelling poop that floats).
- Unexplained weight loss or failure to thrive in infants and children.

**The most recommended supplements for pancreatic enzyme deficiency disorder (EPI) are:** Digestive Enzyme, Probiotic 40, & Vitamin D3.

### 1. Digestive Enzyme

Pancreatic enzyme deficiency disorder, also known as exocrine pancreatic insufficiency (EPI), is a condition that occurs when the pancreas fails to produce enough digestive enzymes. These enzymes play a crucial role in breaking down fats, proteins, and carbohydrates in the food we consume, enabling optimal absorption of nutrients by the body. When EPI is present, the lack of these necessary enzymes can lead to various gastrointestinal symptoms, such as weight loss, diarrhea, and malnutrition. However, there is hope for individuals diagnosed with EPI, as digestive enzyme supplements can effectively manage the condition and improve overall quality of life. These supplements typically contain pancreatic enzymes, such as lipase, protease, and amylase, which help to break down fats, proteins, and carbohydrates, respectively. By taking these supplements with meals, individuals with EPI can compensate for the insufficient enzyme production by their pancreas, ensuring proper digestion and absorption of nutrients. It is important to note that these supplements should be taken under the guidance of a healthcare professional who can determine the appropriate dosage and







## 9. TO IMPROVE PANCREAS FUNCTION

The pancreas is an organ in the back of your abdomen (belly). It is part of your digestive system. The pancreas is an organ and a gland. Glands are organs that produce and release substances in the body.

The pancreas performs two main functions:

- **Exocrine function:** Produces substances (enzymes) that help with digestion.
- **Endocrine function:** Sends out hormones that control the amount of sugar in your bloodstream.

Eating a healthy diet and limiting your exposure to harmful substances, like tobacco and alcohol, can help keep your pancreas and your entire digestive system working properly.

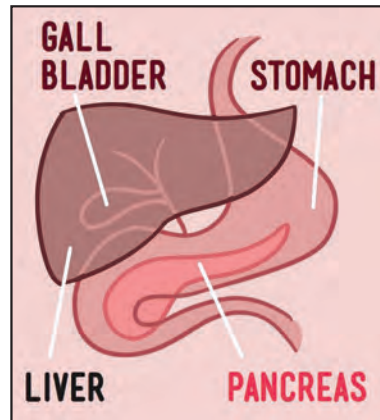

**The most recommended supplements to improve pancreatic functions are:** Digestive Enzyme, Organic Spirulina, & Probiotics.

### 1. Digestive Enzyme

Digestive enzymes play a crucial role in improving pancreatic functions. The pancreas, an organ located behind the stomach, produces and releases these enzymes into the small intestine to aid in the digestion and absorption of nutrients. These enzymes break down complex carbohydrates, proteins, and fats into simpler forms that can be easily absorbed by the body. However, individuals with pancreatic insufficiency, a condition characterized by a lack of sufficient enzyme production, may experience difficulties in digesting food properly. In such cases, taking digestive enzyme supplements can be highly beneficial. These supplements contain a combination of enzymes, including amylase, protease, and lipase, which help break down carbohydrates, proteins, and fats, respectively. By supplementing the body with these enzymes, individuals with pancreatic insufficiency can improve their ability to digest food and absorb essential nutrients. This can lead to better overall health and a reduction in symptoms such as bloating, gas, and diarrhea. Moreover, digestive enzyme supplements can also alleviate the strain on the pancreas, allowing it to rest and recover. This is particularly important for individuals with conditions such as chronic pancreatitis, where the pancreas is inflamed and needs time to heal. In addition to pancreatic insufficiency, digestive enzyme supplements can also benefit those with conditions such as lactose intolerance, gluten sensitivity, or irritable bowel syndrome (IBS). These supplements can help individuals better tolerate certain foods by providing the necessary enzymes to break down specific components that may otherwise cause discomfort or digestive distress.

**Ingredients:** see Supplement Facts.

**Manufacturer Country:** USA

**Product Amount:** 60 caps

**Gross Weight:** 0.25lb (133g)

**Suggested Use:** Take one (1) capsule twice a day as a dietary supplement. For best results, take 20-30 min before a meal or as directed by your healthcare professional.

**Caution:** Do not exceed recommended dose. Pregnant or nursing mothers, children under the age of 18, and individuals with a known medical condition should consult a physician before using this or any dietary supplement.

**Warning:** Keep out of reach of children. Do not use if the safety seal is damaged or missing. Store in a cool, dry place.

The Food and Drug Administration has not evaluated these statements. This product is not intended to diagnose, treat, cure or prevent any disease.

## 2. Organic Spirulina

Organic Spirulina is a natural superfood that has gained significant attention for its potential to improve pancreatic functions. The pancreas plays a crucial role in the body's digestive system by producing digestive enzymes and hormones, including insulin. However, various factors such as poor diet, stress, and environmental toxins can impair pancreatic functions, leading to conditions like pancreatitis, diabetes, and insulin resistance. Organic Spirulina, a blue-green algae, is packed with essential nutrients, including vitamins, minerals, antioxidants, and phytonutrients. Its unique composition makes it a powerful tool for supporting pancreatic health. Spirulina contains high levels of chlorophyll, which has been shown to enhance the production of pancreatic enzymes, aiding in digestion and nutrient absorption. Additionally, Spirulina is rich in antioxidants like beta-carotene and vitamin C, which help protect the pancreas from oxidative stress and inflammation. Furthermore, studies have suggested that Spirulina may have a positive impact on blood sugar regulation, potentially benefiting individuals with diabetes or insulin resistance. It is believed that Spirulina's high protein content and unique blend of nutrients improve insulin sensitivity and promote the production of healthy pancreatic cells. Moreover, Spirulina's anti-inflammatory properties can help reduce pancreatic inflammation and prevent further damage. Incorporating organic Spirulina into one's diet, whether in powder or supplement form, may offer a natural, holistic approach to supporting pancreatic functions and overall well-being.

Our Organic Spirulina Powder is rich in essential amino acids lysine, methionine, cysteine, threonine, and phenylalanine which are crucial for supporting regular body functions. Furthermore, Spirulina has very high levels of iron, beta-carotene, and B vitamins. Spirulina is the perfect addition to your favorite smoothies and smoothie bowls.

**Ingredients:** see Supplement Facts.

**Manufacturer Country:** USA

**Product Amount:** 0.26lb (120g)

**Gross Weight:** 0.27lb (125g)

**Suggested Use:** The recommended starting dosage is ½ teaspoon a day, gradually increasing to 3 teaspoons, taken with food or around an hour before mealtimes.

**Warning:** Keep out of reach of children. Do not use if the safety seal is damaged or missing. Store in a cool, dry place.

The Food and Drug Administration has not evaluated these statements. This product is not intended to diagnose, treat, cure or prevent any disease.

	Amount Per Serving	% Daily Value
Vitamin A	400 IU	8%
Vitamin C	30 mg	30%
Threonine	2.1 mg	1%
Methionine	1.1 mg	1%
Lysine	1.1 mg	1%
Vitamin B12	0.1 mg	2%
Iron	2.1 mg	12%
Phosphorus	20 mg	2%
Calcium	30 mg	3%
Magnesium	11 mg	2%
Copper	0.2 mg	20%
Manganese	0.1 mg	2%
Selenium	10 mg	2%



vitamin D3 may enhance the production and secretion of insulin, thereby improving blood sugar regulation. Additionally, studies have indicated that vitamin D3 may have anti-inflammatory properties, which could further benefit the pancreas by reducing inflammation and oxidative stress. Furthermore, deficiencies in vitamin D3 have been associated with an increased risk of developing type 2 diabetes and pancreatic cancer. Supplementation with vitamin D3 may help prevent or manage these conditions by promoting healthy pancreatic functions.

Vitamin D3 is a fat-soluble vitamin that supports the growth and development of bones and teeth. It also plays an essential role in the functioning of the muscles and boosting energy levels in the body.

The body naturally produces Vitamin D when exposed to sunlight, and you can also receive Vitamin D from some foods like oily fish. In the winter months, especially in colder regions, the body doesn't produce as much Vitamin D, which can lead to what's called 'seasonal depression.'

**Ingredients:** see Supplement Facts.

**Manufacturer Country:** USA

**Product Amount:** 100 softgels

**Gross Weight:** 0.1lb (45g)

**Suggested Use:** As a dietary supplement, adults take one (1) softgel capsule daily or as directed by a health care professional. Store in a cool, dry place and away from direct light.

## 10. OBESITY/ WEIGHT LOSS

Overweight and obesity are defined as abnormal or excessive fat accumulation that presents a risk to health. A body mass index (BMI) over 25 is considered overweight, and over 30 is obese. The terms "overweight" and "obesity" refer to body weight that is greater than what is considered normal or healthy for a certain height. Being overweight is generally due to extra body fat. However, overweight may also be due to extra muscle, bone, or water. People who have obesity usually have too much body fat. Women with more than 30 percent body fat and men with more than 25 percent body fat are considered obese. Morbid obesity is defined as having a Body Mass Index (BMI) of more than 40, which equates to approximately 100 pounds overweight for men and 80 pounds for women. Obesity is a complex disease involving an excessive amount of body fat. Obesity isn't just a cosmetic concern. It's a medical problem that increases the risk of other diseases and health problems, such as heart disease, diabetes, high blood pressure and certain cancers.

There are many reasons why some people have difficulty losing weight. Usually, obesity results from inherited, physiological and environmental factors, combined with diet, physical activity and exercise choices. The good news is that even modest weight loss can improve or prevent the health problems associated with obesity. A healthier diet, increased physical activity and behavior changes can help you lose weight.

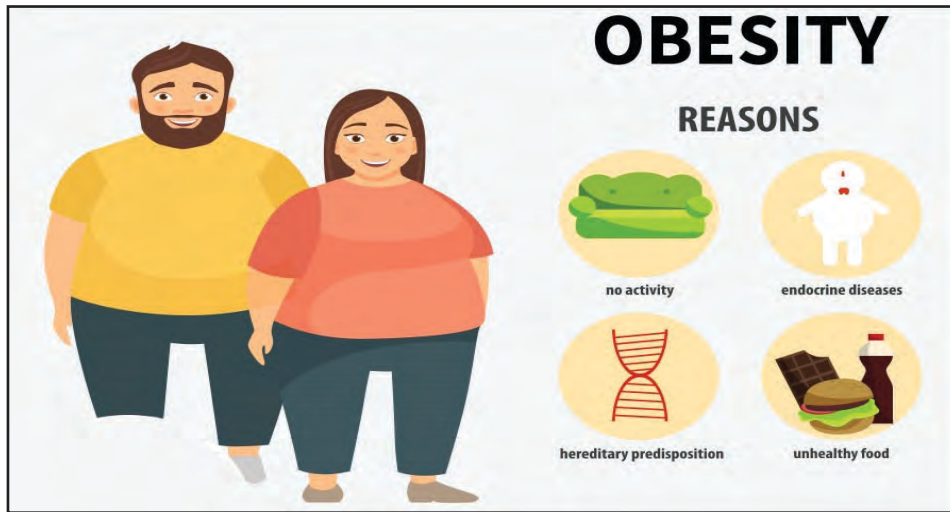

**# Symptoms**

Body mass index (BMI) is often used to diagnose obesity. To calculate BMI, multiply weight in pounds by 703, divide by height in inches and then divide again by height in inches. Or divide weight in kilograms by height in meters squared.

BMI	Weight status
Below 18.5	Underweight
18.5-24.9	Normal
25.0-29.9	Overweight
30.0 and higher	Obesity

Asians with BMI of 23 or higher may have an increased risk of health problems. For most people, BMI provides a reasonable estimate of body fat. However, BMI doesn't directly measure body fat, so some people, such as muscular athletes, may have a BMI in the obesity category even though they don't have excess body fat.

Many doctors also measure a person's waist circumference to help guide treatment decisions. Weight-related health problems are more common in men with a waist circumference over 40 inches (102 centimeters) and in women with a waist measurement over 35 inches (89 centimeters).

**The recommended supplements for weight loss are:** Super Fat Burner, High Protein Meal Replacement, & Keto-5.

**1. Super Fat Burner**

Super Fat Burner with MCT combines Vitamin C, Vitamin B6, Choline, Chromium, L-Carnitine, and medium-chain triglycerides (MCT) to deliver a healthy approach to fat burning and consequent weight loss.

Burning fat is difficult for some individuals. Therefore, they must supplement with an effective fat burner with the correct ingredients to drive better results.

Choline is an essential nutrient that promotes healthy liver and lessens the likelihood of developing fatty liver disease. MCTs appear to increase thermogenesis, or heat production in the body, which aids dieters in fat burning and weight loss.

**Ingredients:** see Supplement Facts.

**Manufacturer Country:** USA

**Product Amount:** 90 capsules.

**Gross Weight:** 0.2lb (90.7g)

**Suggested Use:** 4 capsules daily, preferably with meals or as directed by a healthcare professional. For best results, take 2 capsules with 8 ounces of water before breakfast and again before dinner. This product should be used in conjunction with a sensible diet and exercise





## CHAPTER VII. IMMUNE SYSTEM

The immune system is a complex network of organs, cells and proteins that defends the body against infection, whilst protecting the body's own cells. The immune system keeps a record of every germ (microbe) it has ever defeated so it can recognise and destroy the microbe quickly if it enters the body again.

### What is the immune system?

The immune system protects your child's body from outside invaders. These include germs such as bacteria, viruses, and fungi, and toxins (chemicals made by microbes). The immune system is made up of different organs, cells, and proteins that work together.

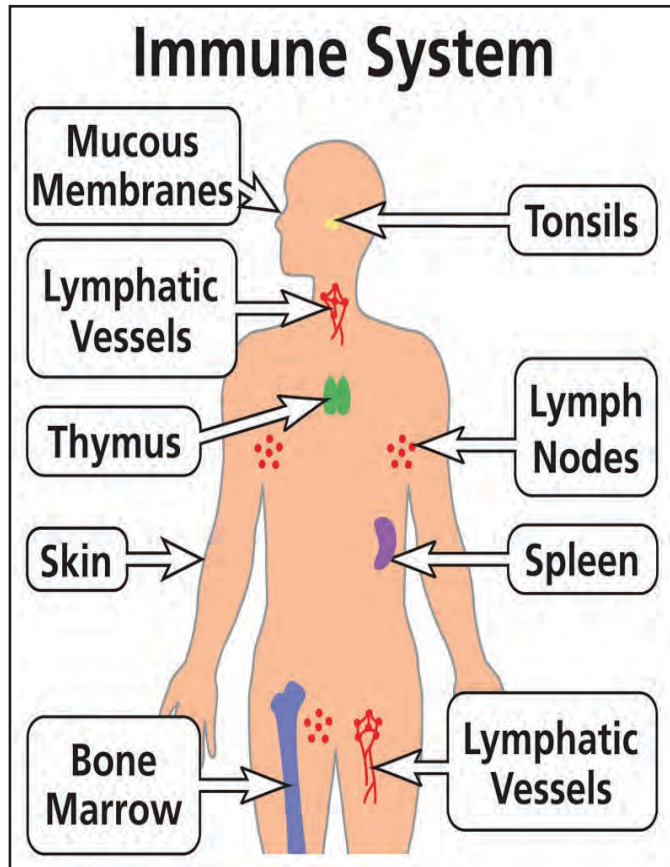

There are 2 kinds immune system:

- **The innate immune system.** You are born with this.
- **The adaptive immune system.** You develop this when your body is exposed to microbes or chemicals released by microbes.

These 2 immune systems work together.

### The innate immune system

This is your child's rapid response system. It is the first to respond when it finds an invader. It is made up of the skin, the eye's cornea, and the mucous membrane that lines the respiratory, gastrointestinal, and genitourinary tracts. These all create physical barriers to help protect your child's body. They protect against harmful germs, parasites (such as worms), or cells (such as cancer). The innate immune system is inherited. It is active from the moment your child is born. When this system recognizes an invader, it goes into action right away. The cells of this immune system surround and cover the invader. The invader is killed inside the immune system cells (called phagocytes).



## The acquired immune system

The acquired immune system, with help from the innate system, makes special proteins (called antibodies) to protect your body from a specific invader. These antibodies are developed by cells called B lymphocytes after the body has been exposed to the invader. The antibodies stay in your child's body. It can take several days for antibodies to form. But after the first exposure, the immune system will recognize the invader and defend against it. The acquired immune system changes during your child's life. Immunizations train your child's immune system to make antibodies to protect them from harmful diseases.

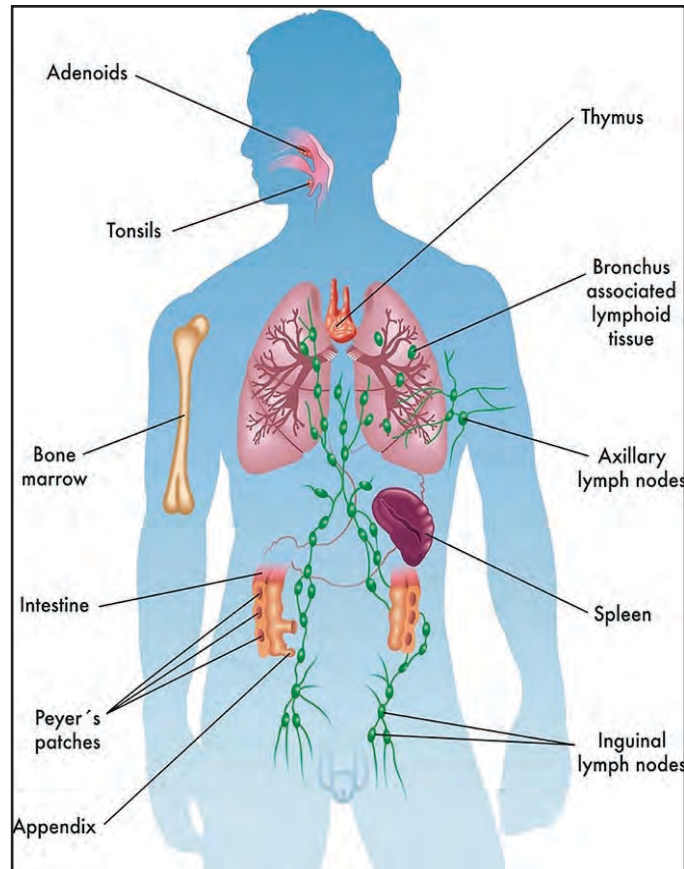

## 1. FIBROMYALGIA

Fibromyalgia is a disorder characterized by widespread musculoskeletal pain accompanied by fatigue, sleep, memory and mood issues. Fibromyalgia, pronounced fi-bro-my-al-gi-a, is a condition that causes widespread pain throughout the body. It can cause sleep problems, fatigue and mental or emotional distress. Patients with fibromyalgia often experience abnormal pain perception processing, which is a sensitivity to pain those without it do not have.

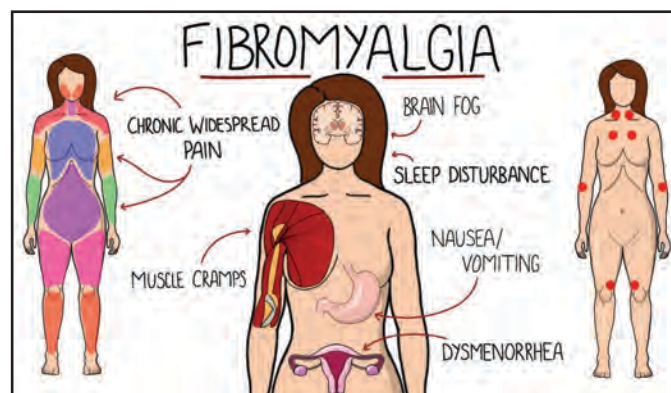

## #Symptoms

The primary symptoms of fibromyalgia include:

- **Widespread pain.** The pain associated with fibromyalgia often is described as a constant dull ache that has lasted for at least three months. To be considered widespread, the pain must occur on both sides of your body and above and below your waist.
- **Fatigue.** People with fibromyalgia often awaken tired, even though they report sleeping for long periods of time. Sleep is often disrupted by pain, and many patients with fibromyalgia have other sleep disorders, such as restless legs syndrome and sleep apnea.
- **Cognitive difficulties.** A symptom commonly referred to as “fibro fog” impairs the ability to focus, pay attention and concentrate on mental tasks.

**Fibromyalgia often co-exists with other conditions, such as:**

- Irritable bowel syndrome
- Chronic fatigue syndrome
- Migraine and other types of headaches
- Interstitial cystitis or painful bladder syndrome
- Temporomandibular joint disorders
- Anxiety
- Depression
- Postural tachycardia syndrome

**The recommended supplements for fibromyalgia are:** CoQ10, Chaga Mushroom, & Magnesium Glycinate.

### 1. CoQ10 Ubiquinone

Coenzyme Q10 (CoQ10), also known as ubiquinone, is a naturally occurring compound found in every cell of the human body. It plays a vital role in energy production within the mitochondria, the powerhouses of our cells. While its primary function is to generate adenosine triphosphate (ATP), the currency of cellular energy, CoQ10 has also been found to have numerous health benefits, including its potential to enhance the immune system. The immune system is our body’s defense mechanism against harmful pathogens, viruses, and bacteria. It consists of a complex network of cells, tissues, and organs working together to identify and neutralize foreign invaders. CoQ10 has been observed to support the immune system by promoting the production of antibodies and enhancing the activity of certain immune cells. It acts as an antioxidant, protecting immune cells from oxidative damage, and aids in the regulation of inflammation. Additionally, CoQ10 has been found to improve the function of natural killer (NK) cells, which are responsible for targeting and destroying cancer cells and infected cells.

**Ingredients:** see Supplement Facts.

**Manufacturer Country:** USA

**Product Amount:** 30 caps

**Gross Weight:** 0.25lb (113g)

**Suggested Use:** Take one (1) capsule twice a day as a dietary supplement. For best results, take 20-30 min before a meal or as directed by your healthcare professional.

**Caution:** Do not exceed recommended dose. Pregnant or nursing mothers, children under the age of 18, and individuals with a known medical condition should consult a physician before using this or any dietary supplement.

**Warning:** Keep out of reach of children. Do not use if the safety seal is damaged or missing. Store in a cool, dry place.

The Food and Drug Administration has not evaluated these statements. This product is not intended to diagnose, treat, cure or prevent any disease.



## 2. Chaga Mushroom

CoQ10 ubiquinone has gained significant attention as a potential treatment for fibromyalgia, a chronic disorder characterized by widespread musculoskeletal pain, fatigue, and cognitive difficulties. Fibromyalgia affects millions of people worldwide, and its exact cause remains unknown, making it a challenging condition to manage. However, research suggests that CoQ10 ubiquinone may offer some relief to individuals suffering from this debilitating condition. CoQ10 ubiquinone is a naturally occurring enzyme found in every cell of the body and plays a crucial role in energy production. It acts as a powerful antioxidant, protecting cells from oxidative damage and promoting their overall health. Studies have shown that individuals with fibromyalgia often have reduced levels of CoQ10 ubiquinone in their blood, which may contribute to the symptoms experienced. By supplementing with CoQ10 ubiquinone, it is believed that the body's energy production and antioxidant defenses can be enhanced, potentially alleviating some of the symptoms associated with fibromyalgia. Furthermore, CoQ10 ubiquinone has been found to improve mitochondrial function, which is crucial for cellular energy production. Mitochondrial dysfunction is believed to be a contributing factor to the development of fibromyalgia symptoms, and CoQ10 ubiquinone's ability to improve mitochondrial function may help restore energy levels and reduce fatigue in individuals with fibromyalgia.

**Ingredients:** see Supplement Facts.

**Manufacturer Country:** USA

**Product Amount:** 60 vegan capsules

**Gross Weight:** 0.2lb (90g)

**Suggested Use:** As a dietary supplement, adults take two (2) capsules daily or as directed by a healthcare professional. Can be taken with food or on an empty stomach.

**Warning:** Keep out of reach of children. Do not use if the safety seal is damaged or missing. Store in a cool, dry place and away from direct light.

The Food and Drug Administration has not evaluated these statements. This product is not intended to diagnose, treat, cure or prevent any disease.

**DrSous.Ca Chaga Mushroom body balance and immunological 60 Capsules**

Regular price: \$19.95 CAD  
Amount: 60 vegan capsules  
Gross Weight: 0.2lb (90g)

Chaga Mushroom Capsules are loaded with essential nutrients for optimized body functioning. The most notable of these nutrients are phytochemicals. Phytochemicals are plant-based molecules that stimulate the immunological and hormonal systems and play an essential part in maintaining the balance of our bodies.

Supplement Facts	
Serving Size: 2 Vegan Capsules Servings Per Container: 30	
	Amount Per % Daily Serving Value
Organic Chaga (Inonotus obliquus) Mushroom Mycelium Powder (Standardized to 40% polysaccharides (400mg))	1000 mg
*Daily Value not established.	
Other Ingredients: vegan capsule (modified cellulose, water), silica.	

www.paradisowellness.ca | Dr. Sous | www.drsous.ca

## 3. Magnesium Glycinate

Magnesium Glycinate has gained attention as a potential treatment for fibromyalgia, a chronic condition characterized by widespread pain, fatigue, and tender points. Fibromyalgia is a complex disorder with no known cure, and its symptoms can significantly impact the quality of life for those affected. However, magnesium has been shown to play a crucial role in various bodily functions, including muscle and nerve function, energy production, and the regulation of blood pressure. Magnesium Glycinate, a highly absorbable form of magnesium, has been suggested as a potential therapeutic option for individuals with fibromyalgia. Research suggests that magnesium deficiency may contribute to the development and worsening of fibromyalgia symptoms. Several studies have reported lower levels of magnesium in individuals with fibromyalgia compared to healthy individuals. Magnesium supplementation, including Magnesium Glycinate, has been investigated for its potential to alleviate fibromyalgia symptoms. One of the key benefits of Magnesium Glycinate

is its high bioavailability, meaning that it is easily absorbed and utilized by the body. This form of magnesium has been found to have superior absorption compared to other forms, such as magnesium oxide. This increased absorption may be particularly beneficial for individuals with fibromyalgia, as they may have impaired nutrient absorption due to gastrointestinal issues frequently associated with the condition. Magnesium Glycinate is thought to exert its effects on fibromyalgia symptoms through various mechanisms. Firstly, magnesium is involved in the regulation of neurotransmitters, such as serotonin and dopamine, which play a role in pain perception and mood regulation. By modulating these neurotransmitters, magnesium may help reduce pain sensitivity and improve mood in individuals with fibromyalgia. Additionally, magnesium is known to have muscle-relaxant properties, which can help alleviate the muscle stiffness and tension commonly experienced by fibromyalgia patients. Several small-scale studies and anecdotal reports have shown promising results regarding the use of Magnesium Glycinate for fibromyalgia. These studies have reported improvements in pain levels, sleep quality, fatigue, and overall well-being in individuals who supplemented with magnesium. However, it is important to note that more extensive research is needed to fully understand the efficacy and safety of Magnesium Glycinate for fibromyalgia.



## 2. MULTIPLE SCLEROSIS

Multiple sclerosis is a disease of the central nervous system that results in the malfunctioning of the brain's communication with the nerves. The disease occurs when protective coating around the nerves degrades. This coating, called myelin, is essential for preserving nerve endings and other parts of the nervous system free of damage.

It is not known precisely why myelin suffers damages, but doctors suggest that the immune system may attack myelin for unknown reasons. As myelin is damaged, the nerves' communication with the brain is impaired. This results in a range of problems ranging from lack of feeling in certain body parts to total immobility.

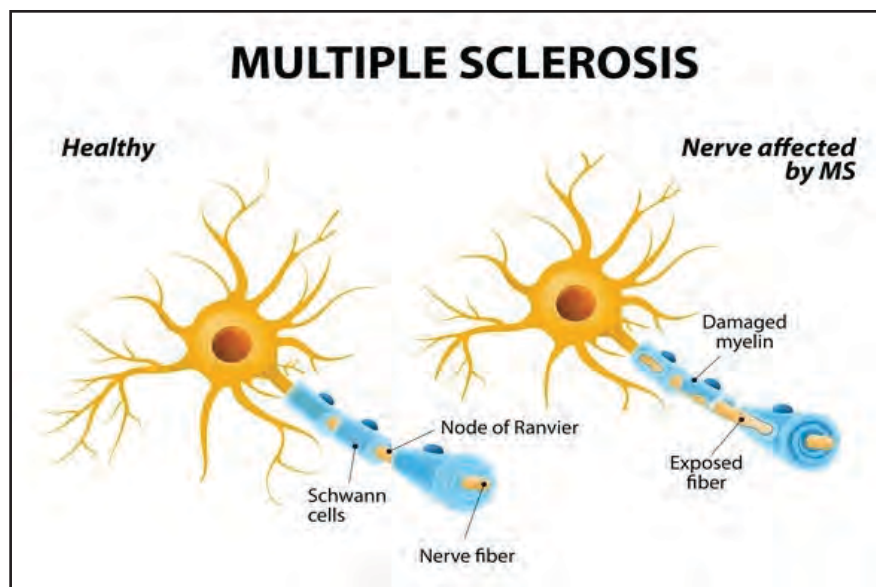

## Diagnosing Multiple Sclerosis

Diagnosing multiple sclerosis is usually based on the suffering of common symptoms. If you or a loved one have been experiencing any of these effects, you might need to consult with a doctor:

- Numbness in the fingers, face, or other body parts
- Weakness in the legs or hands
- Blurred vision
- Loss of eyesight
- Bowel malfunctions
- Chronic fatigue
- Slurring of the speech

## # Symptoms

Numbness and tingling in the limbs and face are one of the first symptoms that appear in MS patients. Other parts of the body may experience this sensation as well. The “pins and needles” sensation may be mildly annoying or so intense that it is incapacitating. In cases where these symptoms are severe, individuals may face difficulty in performing routine, day-to-day tasks. Medication may help to restore feeling. However, there is no cure to alleviate numbness and tingling.

A large majority of MS patients report having muscle spasms at some point. These are sharp, involuntary twitches of muscle groups usually affecting legs, however, other body parts may experience spasms as well. Frequent and severe muscle spasms may be debilitating. Most individuals suffering from MS also feel stiffness in the region prone to spasms. Fortunately, there are several ways of achieving relief from MS-triggered muscle spasms, including medication, physiotherapy, and alternative remedies.

It is common for people with MS to feel light-headed or to suffer from episodes of vertigo. Both vertigo and dizziness put patients at risk of losing their balance and becoming injured due to falls. Experts suggest that such MS symptoms imply that there is a lesion in the brain stem or cerebellum. Treatment for vertigo and dizziness involves over-the-counter medication for motion sickness in mild cases and of corticosteroids in severe cases.

**The recommended supplements for multiple sclerosis are: Vitamin D3, Platinum Turmeric, & CoQ10.**

### 1. Vitamin D3

Multiple sclerosis (MS) is a chronic autoimmune disease that affects the central nervous system, causing a variety of symptoms including muscle weakness, fatigue, and problems with coordination and balance. Over the years, researchers have been exploring various treatment options to alleviate the symptoms and slow down the progression of this debilitating disease. One such avenue of investigation is the potential role of Vitamin D3 in managing MS. Vitamin D3, also known as cholecalciferol, is a crucial nutrient that is synthesized in the skin upon exposure to sunlight. It plays a vital role in maintaining bone health and regulating the immune system. Several studies have suggested a link between Vitamin D deficiency and an increased risk of developing MS, as well as a correlation between low Vitamin D levels and more severe MS symptoms. Moreover, research has indicated that Vitamin D3 supplementation may have beneficial effects on MS patients. It is believed that Vitamin D3 modulates the immune response by reducing inflammation and promoting the expression of anti-inflammatory cytokines. Additionally, it may enhance the production of myelin, the protective covering of nerve fibers that is damaged in MS.

**Ingredients:** see Supplement Facts.

**Manufacturer Country:** USA

**Product Amount:** 100 Soft-gels

**Gross Weight:** 0.11lb (45g)

**Suggested Use:** As a dietary supplement, adults take one (1) soft-gel capsule daily or as directed by a health care professional. Store in a cool, dry place and away from direct light.

**DR SOUS.CA Vitamin D3 helps maintain bone density, strength and healthy cell growth**

Vitamin D3 is a fat-soluble vitamin that supports the growth and development of bones and teeth. It also plays an essential role in the functioning of the muscles and boosting energy levels in the body. The body naturally produces Vitamin D when exposed to sunlight, and you can also receive Vitamin D from some foods like oily fish. In the winter months, especially in colder regions, the body doesn't produce as much Vitamin D, which can lead to what's called "seasonal depression."

www.drsoous.ca A specific channel for Supplements on YouTube

154

Dr. South | www.drsoous.ca

## 2. Platinum Turmeric

Platinum Turmeric has gained significant attention in recent years as a potential natural remedy for multiple sclerosis (MS). MS is a chronic autoimmune disease that affects the central nervous system, causing a range of debilitating symptoms. The active ingredient in Platinum Turmeric, curcumin, has long been recognized for its anti-inflammatory and antioxidant properties. These properties make it a promising candidate for alleviating symptoms associated with MS. Research studies have shown that curcumin can suppress the activity of immune cells responsible for initiating inflammation in the nervous system, which is a hallmark of MS. Additionally, curcumin has been found to protect nerve cells from oxidative stress, which can contribute to the progression of MS. By reducing inflammation and oxidative stress, Platinum Turmeric may help to alleviate symptoms such as fatigue, muscle weakness, and cognitive impairment experienced by individuals with MS.

Our Platinum Turmeric blend contains various forms of turmeric, glucosamine, Boswellia extract (frankincense), piperine, and several other highly beneficial natural extracts to keep you at your best.

Natural extracts have been used for centuries in Ayurvedic medicine to remedy illnesses. We harness and advance these natural extracts in modern times for optimal bioavailability and effectiveness.

**Ingredients:** see Supplement Facts.

**Manufacturer Country:** USA

**Product Amount:** 60 caps

**Gross Weight:** 0.25lb (113g)

**Suggested Use:** Take two (2) capsules once a day as a dietary supplement. For best results, take 20-30 min before a meal or as directed by your healthcare professional.



## 3. CoQ10

CoQ10 Ubiquinone, also known as coenzyme Q10, is a naturally occurring compound that plays a crucial role in the body's energy production process. It is widely recognized for its antioxidant properties, which help protect cells from oxidative damage and support overall health. Multiple sclerosis (MS) is a chronic autoimmune disease that affects the central nervous system, causing inflammation and damage to the myelin sheath surrounding nerve fibers. While there is no cure for MS, researchers have been exploring various treatment options, including the potential benefits of CoQ10 Ubiquinone supplementation. Studies have suggested that CoQ10 Ubiquinone may have neuroprotective effects, reducing inflammation and oxidative stress in the central nervous system. These effects may help slow down disease progression and alleviate some of the symptoms associated with MS. Additionally, CoQ10 Ubiquinone has been found to improve energy metabolism, supporting mitochondrial function in cells. This can be particularly beneficial for individuals with MS, as the disease often leads to fatigue and decreased energy levels.

**Ingredients:** see Supplement Facts.

**Manufacturer Country:** USA

**Product Amount:** 30 caps

**Gross Weight:** 0.25lb (113g)

**Suggested Use:** Take one (1) capsule twice a day as a dietary supplement. For best results, take 20-30 min before a meal or as directed by your healthcare professional.

**Caution:** Do not exceed recommended dose. Pregnant or nursing mothers, children under the age of 18, and individuals with a known medical condition should consult a physician before using this or any dietary supplement.

**Warning:** Keep out of reach of children. Do not use if the safety seal is damaged or missing. Store in a cool, dry place.

The Food and Drug Administration has not evaluated these statements. This product is not intended to diagnose, treat, cure or prevent any disease.



### 3) MYASTHENIA GRAVIS

Myasthenia gravis is a chronic autoimmune, neuromuscular disease that causes weakness in the skeletal muscles (the muscles that connect to your bones and contract to allow body movement in the arms and legs, and allow for breathing).

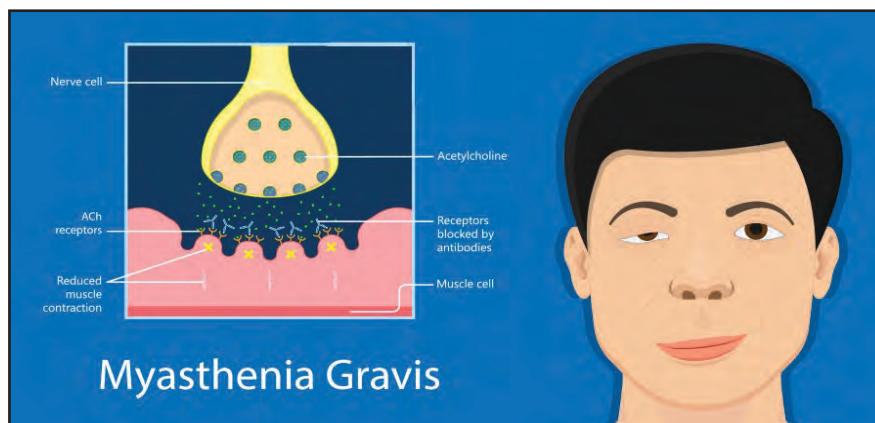

#### What causes myasthenia gravis?

Myasthenia gravis is not inherited and it is not contagious. It generally develops later in life when antibodies in the body attack normal receptors on muscle. This blocks a chemical needed to stimulate muscle contraction. Myasthenia gravis is a rare long-term condition that causes muscle weakness. It most commonly affects the muscles that control the eyes and eyelids, facial expressions, chewing, swallowing and speaking. But it can affect most parts of the body.

#### # Symptoms

- Weakness of the eye muscles (ocular myasthenia)
- Drooping of one or both eyelids (ptosis)

- Blurred or double vision (diplopia)
- Changes in facial expressions.
- Difficulty swallowing.
- Shortness of breath.
- Impaired speech (dysarthria)
- Weakness in the arms, hands, fingers, legs, and neck.

**The recommended supplement for myasthenia gravis are:** Vitamin D3, B-12 Drops, & CoQ10 Ubiquinone.

### 1. Vitamin D3

Myasthenia gravis is a chronic autoimmune neuromuscular disorder characterized by muscle weakness and fatigue. It occurs when the immune system mistakenly attacks the neuromuscular junction, leading to a decrease in communication between nerves and muscles. While there is no cure for myasthenia gravis, various treatment options aim to manage symptoms and improve quality of life. One such potential treatment is vitamin D3 supplementation. Vitamin D3, also known as the sunshine vitamin, plays a crucial role in promoting healthy bone development, immune function, and muscle strength. Research suggests that individuals with myasthenia gravis often have low levels of vitamin D3, which may contribute to the progression and severity of their symptoms. Studies have shown that vitamin D3 supplementation can have positive effects on muscle strength and function in different neuromuscular disorders, including myasthenia gravis. It is believed that vitamin D3's anti-inflammatory properties and its ability to modulate the immune system could potentially help reduce the autoimmune response associated with myasthenia gravis.

**Ingredients:** see Supplement Facts.

**Manufacturer Country:** USA

**Product Amount:** 100 soft-gels

**Gross Weight:** 0.11lb (45g)

**Suggested Use:** As a dietary supplement, adults take one (1) soft-gel capsule daily or as directed by a health care professional. Store in a cool, dry place and away from direct light.



### 2. B-12 Drops

B-12, also known as cobalamin, is a vital nutrient that plays a crucial role in various bodily functions, including nerve function and cell metabolism. Although B-12 deficiency is not directly linked to myasthenia gravis, some studies suggest that B-12 supplementation may have potential benefits for individuals with this condition. B-12 drops are a convenient and easily absorbable form of B-12 supplementation, making them an attractive option for those seeking alternative treatments. These drops are typically administered sublingually, allowing for quick absorption into the bloodstream without having to pass through the digestive system.



**B-12 Drops**

B12 complex contains: Riboflavin-required for the proper development and function of the skin, lining of the digestive tract, Niacin-required for the proper function of fats and sugars in the body and to maintain healthy tissue, Vitamin B6-needed to maintain proper energy levels. B12 is a critical vitamin that is required for proper development of many body systems and tissues. Deficiency of B12 can lead to many problems such as memory loss and fatigue.

A specific channel for b-12 Drops on YouTube

Dr. Sous | www.drsous.ca

### 3. CoQ10

In recent years, there has been growing interest in the potential benefits of CoQ10 supplementation for myasthenia gravis patients. Several studies have explored the effects of CoQ10 on myasthenia gravis, although the research in this area is still limited. However, the available evidence suggests that CoQ10 may have some positive effects on the disease. CoQ10 is known for its antioxidant properties, and it has been proposed that it could help reduce oxidative stress in individuals with myasthenia gravis. Oxidative stress is thought to contribute to the development and progression of the disease, so reducing it could potentially have a beneficial impact on symptoms. Furthermore, CoQ10 is involved in the production of adenosine triphosphate (ATP), which is a molecule that provides energy to the muscles. Since myasthenia gravis is characterized by muscle weakness, it is hypothesized that CoQ10 supplementation could help improve muscle function and alleviate some of the symptoms associated with the condition.

**Ingredients:** see Supplement Facts.

**Manufacturer Country:** USA

**Product Amount:** 30 caps

**Gross Weight:** 0.25lb (113g)

**Suggested Use:** Take one (1) capsule twice a day as a dietary supplement. For best results, take 20-30 min before a meal or as directed by your healthcare professional.

**Caution:** Do not exceed recommended dose. Pregnant or nursing mothers, children under the age of 18, and individuals with a known medical condition should consult a physician before using this or any dietary supplement.

**Warning:** Keep out of reach of children. Do not use if the safety seal is damaged or missing. Store in a cool, dry place.

The Food and Drug Administration has not evaluated these statements. This product is not intended to diagnose, treat, cure or prevent any disease.

**DRSOUS.CA CoQ10 Ubiquinone**  
energy production source  
supplement 30 Capsules

Regular price: \$24.00 CAD  
Amount: 30 caps  
Gross Weight: 0.25lb (113g)  
Coenzyme Q10 (CoQ10) is an antioxidant and vitamin-like compound that is found naturally in the body and in some foods like oily fish (salmon and tuna) and organ meats (liver).

**Supplement Facts**

Serving Size: 1 Capsule  
Servings Per Container: 30

Amount Per Serving	%DV
Coenzyme Q-10 (Ubiquinone) 200mg	**

\*\* Daily Value (DV) not established

Inactive Ingredients: Cellulose (Vegetable Capsule), Rice Flour.

A specific channel for COQ10 on YouTube

www.paradisewellness.ca | Dr. Sous | www.drsous.ca

#### 4) PERNICIOUS ANEMIA

Pernicious anemia is a relatively rare autoimmune disorder that causes diminishment in dietary vitamin B12 (cobalamin) absorption, resulting in B12 deficiency and subsequent megaloblastic anemia. It affects people of all ages worldwide, particularly those over 60 years of age. When the stomach does not make enough intrinsic factor, the intestine cannot properly absorb vitamin B12. Common causes of pernicious anemia include: Weakened stomach lining (atrophic gastritis).

##### What are pernicious anemia symptoms?

Generally speaking, the longer you go without adequate vitamin B12, the more serious your symptoms are. Early on, people may have mild symptoms they may think are caused by other common conditions. Examples include:

- Diarrhea or constipation.
- Light-headedness when standing up or with exertion.
- Loss of appetite.
- Pale skin (mild jaundice or yellowing of your eyes or skin).
- Shortness of breath (dyspnea), mostly during exercise.
- Heartburn.
- Swollen, red tongue or bleeding gums.

##### Symptoms caused by long-term low vitamin B12 levels

- Confusion.
- Short-term memory loss.
- Depression.
- Loss of balance.
- Numbness and tingling in your hands and feet.
- Problems concentrating.
- Irritability.
- Hallucinations.

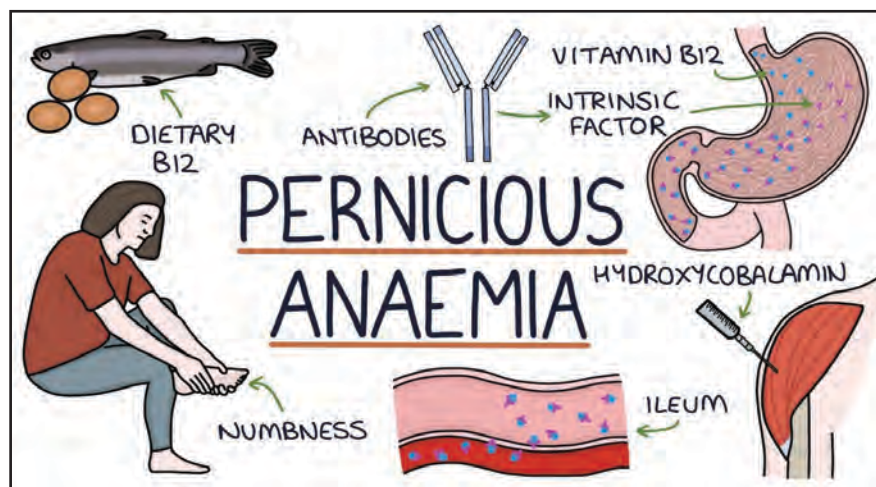

**The recommended supplements for pernicious anemia are:** B-12 Drops, Bee Pearl Powder, & Probiotics.

##### 1. B-12 Drops

Pernicious anemia is a condition characterized by a deficiency of vitamin B12, which is essential for the production of healthy red blood cells. B12 drops have become a popular treatment option for individuals diagnosed with pernicious anemia due to their ease of use and effectiveness. These drops contain a concentrated form of vitamin B12 that can be easily absorbed by the body, making it an

ideal solution for those who struggle with traditional oral supplements. The drops are typically administered sublingually, meaning they are placed under the tongue, where they are quickly absorbed into the bloodstream. This method bypasses the digestive system, which can be beneficial for individuals with malabsorption issues. B12 drops provide a convenient and efficient way to replenish vitamin B12 levels in the body, promoting the production of healthy red blood cells and alleviating the symptoms associated with pernicious anemia. Regular use of B12 drops, as prescribed by a healthcare professional, can help improve energy levels, reduce fatigue, and prevent further complications associated with this condition. It is important to note that B12 drops should be used under medical supervision, as the dosage and frequency may vary depending on the individual's specific needs.



## 2. Bee Pearl Powder

Bee Pearl Powder, a natural supplement derived from bees, has gained attention for its potential benefits in managing pernicious anemia. Pernicious anemia is a condition characterized by a deficiency in vitamin B12, which is essential for red blood cell production and neurological function. Traditionally, the treatment for pernicious anemia involves regular vitamin B12 injections. However, Bee Pearl Powder offers a promising alternative that may help alleviate the symptoms associated with this condition. This unique supplement contains a rich array of nutrients, including vitamins, minerals, amino acids, and enzymes, all of which are essential for optimal health. In particular, Bee Pearl Powder is known for its high vitamin B12 content, making it an excellent natural source of this crucial nutrient. Furthermore, studies have suggested that Bee Pearl Powder may enhance the absorption and utilization of vitamin B12 in the body, making it an ideal supplement for individuals with pernicious anemia. Additionally, Bee Pearl Powder has been associated with various health benefits, such as boosting energy levels, supporting immune function, and promoting overall well-being.

Bee Pearl Powder is a smoothie additive consisting of concentrated bee bread, propolis, and royal jelly.

**Bee bread:** Powerful blend of pollen, nectar, and enzymes packed with nutrients. **Propolis (beeswax):** Beeswax has been utilized for millennia due to its antiviral, antifungal, antibacterial, and anti-inflammatory qualities.

**Royal jelly:** High in vitamins & minerals, including the unique glycoproteins known as Major Royal Jelly Proteins (MRJPs).

Each box contains 30 easy-to-use sachets; add the powder to yogurt, smoothies, or cereal to reap the benefits of the natural bee product. One sachet of Bee Pearl Powder per day provides the optimal daily intake of vitamins, microelements, unsaturated fatty acids, polyphenols, and antioxidants.

**Ingredients:** see Supplement Facts.

**Manufacturer Country:** Latvia

**Product Amount:** 30 sachets

**Gross Weight:** 0.3lb (136g)

**Suggested Use:** Mix one sachet into your smoothie to experience all the health-giving and energy-boosting powers of bee bread, royal jelly, and propolis powder.

**Warning:** Recommended to anyone who is not allergic to bee products. Keep out of reach of children. Do not use if the safety seal is damaged or missing. Store in a cool, dry place.

The Food and Drug Administration has not evaluated these statements. This product is not intended to diagnose, treat, cure or prevent any disease.

**DrSous.ca Bee Pearl Powder**  
**Smoothie with Propolis Royal Jelly**  
 Regular price: \$44.49 CAD  
 Product Amount: 30 sachets

Bee Pearl Powder is pollen, nectar, and enzyme blend in powder form for an effortless addition to your favorite smoothies and other beverages. It is rich in vitamins, microelements, polyphenols, unsaturated fatty acids, and antioxidants. Each box contains 30 easy-to-use sachets; add the powder to yogurt, smoothies, or cereal to reap the benefits of the natural bee product.

- Anti-inflammatory
- Anti-fungal
- Effective immune-booster
- Promotes healthy gut flora

**Supplement Facts**  
 Serving Size: 1 Sachet (1g)  
 Amount Per Serving

	Amount Per Serving	% Daily Value*
Calories	10	2%
Total Fat	0.5g	1%
Total Sugar	0.5g	1%
Total Protein	0.5g	1%
Total Fiber	0.5g	1%
Total Carbohydrate	0.5g	1%
Total Fat (saturated)	0.1g	0.2%
Total Sugar (added)	0.1g	0.2%
Total Protein (added)	0.1g	0.2%
Total Fiber (added)	0.1g	0.2%
Total Carbohydrate (added)	0.1g	0.2%
Total Fat (trans)	0.1g	0.2%
Total Sugar (added)	0.1g	0.2%
Total Protein (added)	0.1g	0.2%
Total Fiber (added)	0.1g	0.2%
Total Carbohydrate (added)	0.1g	0.2%
Total Fat (trans)	0.1g	0.2%
Total Sugar (added)	0.1g	0.2%
Total Protein (added)	0.1g	0.2%
Total Fiber (added)	0.1g	0.2%
Total Carbohydrate (added)	0.1g	0.2%

\*Percent Daily Values are based on a diet of other people's secrets.

© 2018 Dr. Sous. All rights reserved. www.drsous.ca

www.paradisewellness.ca A specific channel for Bee Pearl on YouTube

Dr. Sous | www.drsous.ca

### 3. Spirulina

Spirulina, a nutrient-rich blue-green algae, has gained significant attention in recent years for its potential benefits in managing various health conditions. One such condition is pernicious anemia, a type of anemia caused by a deficiency of vitamin B12. Pernicious anemia can lead to fatigue, weakness, shortness of breath, and other debilitating symptoms. Spirulina, with its high concentration of essential nutrients, including iron, vitamin B12, and folic acid, has shown promise in supporting the treatment of pernicious anemia. Iron is crucial for the production of healthy red blood cells, while vitamin B12 is necessary for their proper functioning. Spirulina's bioavailability and ease of absorption make it an excellent natural source of these vital nutrients. Additionally, the presence of folic acid in spirulina aids in the synthesis of DNA and red blood cells, further supporting the management of pernicious anemia. Furthermore, spirulina is known for its immune-boosting properties, which can help individuals with pernicious anemia maintain overall health and well-being.

**Ingredients:** see Supplement Facts.

**Manufacturer Country:** USA

**Product Amount:** 0.26lb (120g)

**Gross Weight:** 0.27lb (125g)

**Suggested Use:** The recommended starting dosage is ½ teaspoon a day, gradually increasing to 3 teaspoons, taken with food or around an hour before mealtimes.

**Warning:** Keep out of reach of children. Do not use if the safety seal is damaged or missing. Store in a cool, dry place.

The Food and Drug Administration has not evaluated these statements. This product is not intended to diagnose, treat, cure or prevent any disease.

**DrSous.ca Organic Spirulina Powder 120g**

Regular price: \$15.00 CAD  
 Product Amount: 0.26lb (120g)  
 Gross Weight: 0.27lb (125g)

Spirulina is a blue-green algae known for its high protein level and dense nutrient content. Our Organic Spirulina Powder is rich in essential amino acids lysine, methionine, cysteine, threonine, and phenylalanine which are crucial for supporting regular body functions. It is anti-aging & anti-inflammatory.

**Supplement Facts**  
 Serving Size: 1 Scoop (1g)  
 Amount Per Scoop

	Amount Per Scoop	% Daily Value*
Vitamin A	500 IU	10%
Vitamin B1	10 mg	20%
Vitamin B2	1 mg	20%
Vitamin B3	10 mg	20%
Vitamin B6	1 mg	20%
Vitamin B12	100 µg	20%
Vitamin C	10 mg	20%
Vitamin E	10 IU	20%
Vitamin K	10 µg	20%
Calcium	10 mg	20%
Iron	10 mg	20%
Magnesium	10 mg	20%
Zinc	10 mg	20%
Copper	10 mg	20%
Manganese	10 mg	20%
Selenium	10 µg	20%
Chromium	10 µg	20%
Molybdenum	10 µg	20%

\*Percent Daily Values are based on a diet of other people's secrets.

© 2018 Dr. Sous. All rights reserved. www.drsous.ca

Paradise Wellness | A specific channel for Spirulina on YouTube

Dr. Sous | www.drsous.ca

## 5) REACTIVE ARTHRITIS

Reactive arthritis is joint pain and swelling triggered by an infection in another part of the body most often the intestines, genitals or urinary tract. This condition usually targets the knees, ankles and feet. Inflammation also can affect the eyes, skin and the tube that carries urine out of the body (urethra).

### How serious is reactive arthritis?

Up to half of people will have a flare-up of reactive arthritis in the future. In rare cases, the condition may lead to chronic, severe arthritis. This can lead to joint damage.

### Is reactive arthritis progressive?

Reactive arthritis may be self-limiting, frequently recurring, chronic or progressive. Most patients have severe symptoms lasting a few weeks to six months. 15 to 50 percent of cases involve recurrent bouts of arthritis. Chronic arthritis or sacroiliitis occurs in 15–30 percent of cases.

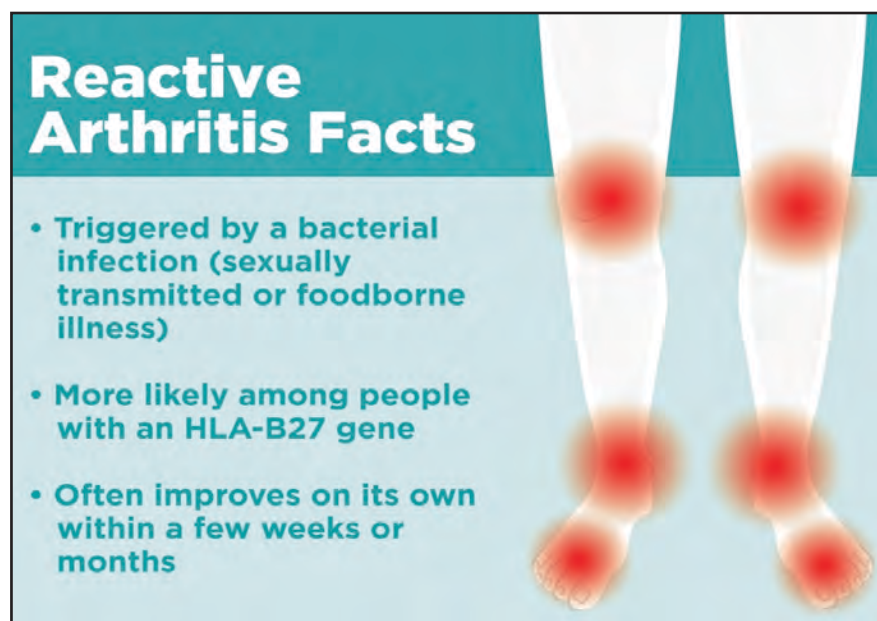

### # Symptoms

- Pain and stiffness. The joint pain associated with reactive arthritis most commonly occurs in the knees, ankles and feet
- Eye inflammation
- Urinary problems
- Inflammation of tendons and ligaments where they attach to bone (enthesitis)
- Swollen toes or fingers
- Skin problems
- Low back pain

**The recommended supplements for reactive arthritis are:** Platinum Turmeric, Collagen, & Vitamin D3.

### 1. Platinum Turmeric

Reactive arthritis is an inflammatory condition that typically develops as a reaction to an infection in the body, often affecting the joints, eyes, and urinary tract. This condition can cause significant discomfort and mobility issues for those affected. However, Platinum Turmeric, derived from the turmeric plant, has been found to possess anti-inflammatory properties that can provide relief for individuals suffering from reactive arthritis. The active compound in turmeric, called curcumin, has been extensively studied for its

ability to reduce inflammation and oxidative stress in the body. By inhibiting various inflammatory pathways, curcumin can help alleviate joint pain, stiffness, and swelling associated with reactive arthritis. Moreover, curcumin's antioxidant properties can help neutralize free radicals, which can contribute to joint damage and worsen symptoms. Platinum Turmeric offers a concentrated form of curcumin, ensuring maximum efficacy for individuals seeking relief from reactive arthritis. Additionally, this supplement is often combined with other ingredients, such as black pepper extract, to enhance curcumin's bioavailability and absorption in the body. This means that Platinum Turmeric not only provides potential therapeutic benefits but also ensures that the body can effectively utilize its active compounds.

**Ingredients:** see Supplement Facts.

**Manufacturer Country:** USA

**Product Amount:** 60 caps

**Gross Weight:** 0.25lb (113g)

**Suggested Use:** Take two (2) capsules once a day as a dietary supplement. For best results, take 20-30 min before a meal or as directed by your healthcare professional.

**DrSous.Ca Platinum Turmeric 60 Capsule Bottle**  
 Regular price: \$20.00 CAD  
 Product Amount: 60 caps  
 Gross Weight: 0.25lb (113g)  
 Our Platinum Turmeric blend contains various forms of turmeric, glucosamine, Boswellia extract (frankincense), piperine, and several other highly beneficial natural extracts to keep you at your best.

- Anti-inflammatory
- Joint and Bone Health
- Heart Protective
- Anti-oxidant & Anti-Cancer

**Supplement Facts**

Amount Per Serving	% DV
113mg Turmeric (Curcumin)	226%
100mg Boswellia Extract	200%
50mg Black Pepper Extract	100%
50mg Glucosamine	100%
50mg Chondroitin	100%
50mg MSM	100%
50mg Vitamin C	100%
50mg Vitamin E	100%
50mg Omega-3	100%
50mg Zinc	100%
50mg Magnesium	100%
50mg Selenium	100%
50mg Manganese	100%
50mg Copper	100%
50mg Boron	100%
50mg Silicon	100%
50mg Vanadium	100%
50mg Molybdenum	100%
50mg Iodine	100%
50mg Fluoride	100%
50mg Chromium	100%
50mg Nickel	100%
50mg Cobalt	100%
50mg Manganese	100%
50mg Selenium	100%
50mg Vanadium	100%
50mg Molybdenum	100%
50mg Iodine	100%
50mg Fluoride	100%
50mg Chromium	100%
50mg Nickel	100%
50mg Cobalt	100%

Other Ingredients: Cellulose, Hydroxypropyl Methylcellulose, Magnesium Stearate, Polyethylene Glycol, Croscarmellose, Polyvinylpyrrolidone, and Titanium Dioxide.

© 2018 Dr. Sous. All rights reserved.

Dr. Sous | www.drsous.ca

## 2. Collagen

Collagen plays a crucial role in the treatment of reactive arthritis. Reactive arthritis, also known as Reiter's syndrome, is an inflammatory condition that typically occurs as a reaction to an infection in another part of the body. It commonly affects the joints, causing pain, stiffness, and swelling. Collagen, the most abundant protein in our bodies, is a fundamental component of connective tissues, including cartilage, tendons, and ligaments. Its structural integrity and function are essential for joint health. In the case of reactive arthritis, collagen supplementation can provide significant benefits. Collagen contains amino acids that support the body's natural production of collagen, helping to rebuild damaged tissues and promote healing. By enhancing cartilage and tissue repair, collagen can alleviate joint inflammation and pain associated with reactive arthritis. Additionally, collagen supplementation can improve joint flexibility and mobility, enabling individuals to engage in their daily activities with reduced discomfort. Moreover, collagen's anti-inflammatory properties make it a valuable treatment option for reactive arthritis. Inflammation is a hallmark of reactive arthritis, and it can cause significant discomfort and impair joint function. Collagen is known to have anti-inflammatory effects, which can help reduce swelling and pain in the affected joints. By modulating the immune response and inhibiting inflammatory mediators, collagen aids in controlling the immune system's overactivity, thus decreasing the severity of reactive arthritis symptoms. Furthermore, collagen's ability to support gut health is relevant in the context of reactive arthritis. Studies have shown a link between gut dysbiosis and reactive arthritis, suggesting that an imbalance in gut bacteria can trigger immune system dysregulation and inflammation. Collagen contains specific amino acids, such as glycine and glutamine, which are beneficial for gut health. These amino acids help repair the intestinal lining, improve digestion, and support a healthy gut microbiome. By promoting gut health, collagen supplementation may indirectly contribute to reducing inflammation and managing reactive arthritis symptoms. Collagen Gummies are for those looking for healthy sweet snacks. These are the perfect replacement for traditional sugar gummies on the market since they provide your body with vital

protein and collagen while also boosting your immune system with Vitamin C.

This is a powerful combination because Vitamin C aids collagen absorption into the bones. This greatly improves bone and joint strength and stability.

**Ingredients:** see Supplement Facts.

**Manufacturer Country:** USA

**Product Amount:** 60 gummies

**Gross Weight:** 0.56lb (255g)

**Suggested Use:** As a dietary supplement, take two (2) pieces once a day.

**Caution:** Do not exceed recommended dose. Pregnant or nursing mothers, children under the age of 18, and individuals with a known medical condition should consult a physician before using this or any dietary supplement.

**Warning:** Keep out of reach of children. Do not use if the safety seal is damaged or missing. Store in a cool, dry place.

The Food and Drug Administration has not evaluated these statements. This product is not intended to diagnose, treat, cure or prevent any disease.

**DrSous.Ca Collagen 60 Gummies**  
**Bottle (Adult)**  
Regular price \$30.00 CAD  
Product Amount: 60 gummies  
Gross Weight: 0.56lb (255g)  
Our Collagen Gummies are delicious while promoting healthy joints, bones, and skin. It contains amino acids, the building blocks of protein, and also contains additional nutrients related to healthy skin and hair like vitamins C, E, biotin, and zinc.

- Joint and bone health
- Improves cardiovascular health
- Boosts muscle mass
- Healthier skin

Supplement Facts	
Serving Size: 2 Pieces Servings Per Container: 30	
Amount Per Serving	% Daily Value*
<b>Collagen</b>	
Total Collagen	24g 24%
Sodium Hyaluronate	1.0g 10%
Sodium Hyaluronate	1.0g 10%
Total Sugars	1.0g 2%
Total Added Sugars	1.0g 2%
Vitamin C (as Ascorbic Acid)	25mg 50%
Vitamin E	5mg 10%
Biotin (as D-Biotin)	5mg 10%
Zinc	2500mcg 500%
Calcium	5mg 10%
Collagen Protein	200mg

\*Percent Daily Values are based on a diet of other people's secrets.

**Other Ingredients:** Sugar, Citraone Syrup, Gelatin, Citraone Powder, Citraone Oil, Citraone Acid, Natural Orange Flavour, Natural Berry Flavour, Citraone Oil, Citraone Concentrate, Water, Sodium Citrate, Purified Citraone Juice Concentrate.

Contains: Fish (Flavour & Oil Fish)

Paradise Wellness  
A specific channel for Collagen Gummies on YouTube

Dr. Sous | www.drsous.ca

### 3. Vitamin D3

Studies have shown that vitamin D3, which is primarily synthesized in the skin upon exposure to sunlight, plays a vital role in modulating the immune system and reducing inflammation. This suggests that maintaining optimal levels of vitamin D3 may have a positive impact on the symptoms and progression of reactive arthritis. Research has indicated that individuals with reactive arthritis often have lower levels of vitamin D3 compared to healthy individuals, emphasizing the importance of adequate supplementation. Vitamin D3 has been shown to regulate the production of certain immune cells, such as T cells, which play a crucial role in the development of inflammation. By modulating the immune response, vitamin D3 may help alleviate the joint pain, stiffness, and swelling associated with reactive arthritis. Additionally, vitamin D3 has been implicated in the regulation of bone health, and since reactive arthritis can lead to bone loss and damage, ensuring sufficient levels of this vitamin is crucial for maintaining joint integrity. Moreover, vitamin D3 has been linked to improved overall musculoskeletal health, as it aids in calcium absorption and promotes optimal muscle function.

**Ingredients:** see Supplement Facts.

**Manufacturer Country:** USA

**Product Amount:** 100 soft-gels

**Gross Weight:** 0.1lb (45g)

**Suggested Use:** As a dietary supplement, adults take one (1) soft-gel capsule daily or as directed by a health care professional. Store in a cool, dry place and away from direct light.

**DRSOUS.CA Vitamin D3 helps maintain bone density, strength and healthy cell growth**

Vitamin D3 is a fat-soluble vitamin that supports the growth and development of bones and teeth. It also plays an essential role in the functioning of the muscles and boosting energy levels in the body. The body naturally produces Vitamin D when exposed to sunlight, and you can also receive Vitamin D from some foods like oily fish. In the winter months, especially in colder regions, the body doesn't produce as much Vitamin D, which can lead to what's called 'seasonal depression.'

www.paradisewellness.ca  
A specific channel for Supplements on YouTube

Dr. Sous | www.drsous.ca

## 6) RHEUMATOID ARTHRITIS

Rheumatoid arthritis, or RA, is an autoimmune and inflammatory disease, which means that your immune system attacks healthy cells in your body by mistake, causing inflammation (painful swelling) in the affected parts of the body. Rheumatoid arthritis is a chronic inflammatory disorder that can affect more than just your joints. In some people, the condition can damage a wide variety of body systems, including the skin, eyes, lungs, heart and blood vessels. An autoimmune disorder, rheumatoid arthritis occurs when your immune system mistakenly attacks your own body's tissues. Unlike the wear-and-tear damage of osteoarthritis, rheumatoid arthritis affects the lining of your joints, causing a painful swelling that can eventually result in bone erosion and joint deformity. The inflammation associated with rheumatoid arthritis is what can damage other parts of the body as well. While new types of medications have improved treatment options dramatically, severe rheumatoid arthritis can still cause physical disabilities.

### # Symptoms

Signs and symptoms of rheumatoid arthritis may include:

- Tender, warm, swollen joints
- Joint stiffness that is usually worse in the mornings and after inactivity
- Fatigue, fever and loss of appetite



Early rheumatoid arthritis tends to affect your smaller joints first — particularly the joints that attach your fingers to your hands and your toes to your feet. As the disease progresses, symptoms often spread to the wrists, knees, ankles, elbows, hips and shoulders. In most cases, symptoms occur in the same joints on both sides of your body. About 40% of people who have rheumatoid arthritis also experience signs and symptoms that don't involve the joints.

### Areas that may be affected include:

- Skin
- Eyes
- Lungs
- Heart
- Kidneys
- Salivary glands
- Nerve tissue
- Bone marrow
- Blood vessels

Rheumatoid arthritis signs and symptoms may vary in severity and may even come and go. Periods of increased disease activity, called flares, alternate with periods of relative remission — when the swelling and pain fade or disappear. Over time, rheumatoid arthritis can cause joints to deform and shift out of place.





a cool, dry place and away from direct light.

**DRSOUS.CA Vitamin D3 helps maintain bone density, strength and healthy cell growth**

Vitamin D3 is a fat-soluble vitamin that supports the growth and development of bones and teeth. It also plays an essential role in the functioning of the muscles and boosting energy levels in the body. The body naturally produces Vitamin D when exposed to sunlight, and you can also receive Vitamin D from some foods like oily fish. In the winter months, especially in colder regions, the body doesn't produce as much Vitamin D, which can lead to what's called 'seasonal depression.'



154

www.paradisewellness.ca A specific channel for Supplements on YouTube

Dr. Sous www.drsous.ca

### 3. Joint Support Gummies

Joint support gummies with glucosamine and vitamin E are a promising solution for individuals suffering from Rheumatoid Arthritis (RA). RA is a chronic autoimmune disease characterized by inflammation of the joints, leading to pain, stiffness, and reduced mobility. Glucosamine, a natural compound found in the body, plays a crucial role in maintaining joint health by stimulating the production of cartilage, the protective tissue that cushions the joints. By incorporating glucosamine into joint support gummies, individuals with RA can benefit from its potential to reduce joint pain and improve joint function. Additionally, vitamin E, a powerful antioxidant, helps to neutralize free radicals that can cause joint damage and inflammation. By including vitamin E in these gummies, they offer an extra layer of protection against oxidative stress, promoting healthier joints. The convenience and palatability of gummies make them an attractive option for those who may struggle with swallowing pills or have difficulty adhering to a medication regimen. Furthermore, the combination of glucosamine and vitamin E in gummy form provides a convenient and effective way to supplement one's diet with these essential nutrients. Overall, joint support gummies with glucosamine and vitamin E offer a promising alternative for individuals with Rheumatoid Arthritis, providing a convenient and enjoyable way to support joint health and potentially alleviate the symptoms associated with this debilitating condition. Joint Support Gummies are a delicious way to get in the necessary level of glucosamine that your body needs to replenish cartilage and tendon tissues around the joints while also increasing the fluid around joints to prevent their breakdown. As the body ages, joints start to ache because of the breakdown of cartilage around the joint. For some, this creates severe discomfort. Cartilage breakdown is more apparent in athletes who push their bodies to the limit. Joint Support Gummies are a delicious way to counteract this.

**Ingredients:** see Supplement facts.

**Flavor:** Raspberry

**Manufacturer Country:** USA

**Product Amount:** 60 gummies

**Gross Weight:** 0.56lb (255g)

**Suggested Use:** Take two (2) gummies once a day as a dietary supplement.

**DRSOUS.CA Joint Support Gummies (Adult)**

Regular price: \$24.40 CAD  
 Product Amount: 60 gummies  
 Gross Weight: 0.56lb (255g)

Joint Support Gummies were made to support athletes through rigorous exercises, to get the necessary level of glucosamine that your body needs to replenish cartilage and tendon tissues.

- Good for arthritis and joint pain
- Aids in athletic performance
- Aids in tissue growth around joints

125

**Supplement Facts**  
 Serving Size: 2 Gummies  
 Servings Per Container: 30

	Amount Per Serving	% Daily Value*
Glucosamine	1500 mg	150%
Chondroitin Sulfate	400 mg	20%
MSM (or Methyl Sulfonyl Methane)	600 mg	20%
Total Sugars	3.5g	7%
Total Added Sugars	3.5g	7%
Total Fat	0.75g	15%
Glucosamine Sulfate	150 mg	15%

\*Percent Daily Values are based on a diet of other people's secrets. © 2020 DRSOUS.CA. All rights reserved. Daily Value not established.

Paradise Wellness A specific channel for Joint support on YouTube

Dr. Sous www.drsous.ca

## 7. CELIAC DISEASE

Celiac disease is a digestive problem that hurts your small intestine. It stops your body from taking in nutrients from food. You may have celiac disease if you are sensitive to gluten. If you have celiac disease and eat foods with gluten, your immune system starts to hurt your small intestine.

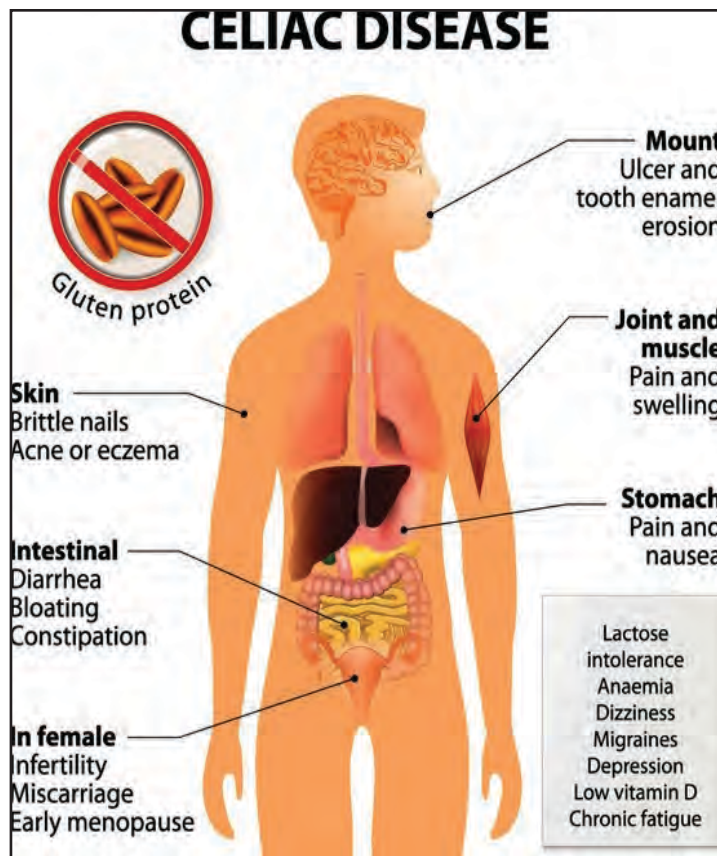

If you have celiac disease, do not eat the following foods, unless they're labelled as gluten-free versions:

- bread
- pasta
- cereals
- biscuits or crackers
- cakes and pastries
- pies
- gravies and sauces

Celiac disease, sometimes called celiac sprue or gluten-sensitive enteropathy, is an immune reaction to eating gluten, a protein found in wheat, barley and rye. If you have celiac disease, eating gluten triggers an immune response in your small intestine. Over time, this reaction damages your small intestine's lining and prevents it from absorbing some nutrients (malabsorption). The intestinal damage often causes diarrhea, fatigue, weight loss, bloating and anemia, and can lead to serious complications. In children, malabsorption can affect growth and development, besides causing the symptoms seen in adults. There's no cure for celiac disease — but for most people, following a strict gluten-free diet can help manage symptoms and promote intestinal healing.

### # Symptoms

The signs and symptoms of celiac disease can vary greatly and differ in children and adults. Digestive signs and symptoms for adults include:

- Diarrhea
- Fatigue
- Weight loss
- Bloating and gas
- Abdominal pain
- Nausea and vomiting
- Constipation

### Children

Children with celiac disease are more likely than adults to have digestive problems, including:

- Nausea and vomiting
- Chronic diarrhea
- Swollen belly
- Constipation
- Gas
- Pale, foul-smelling stools

### The inability to absorb nutrients might result in:

- Failure to thrive for infants
- Damage to tooth enamel
- Weight loss
- Anemia
- Irritability
- Short stature
- Delayed puberty
- Neurological symptoms, including attention-deficit/hyperactivity disorder (ADHD), learning disabilities, headaches, lack of muscle coordination and seizures

**The recommended supplements for celiac disease are:** Probiotic 40, Birch Chaga Microbiome, & Digestive Enzyme.

### 1. Probiotics

Probiotics have gained significant attention in recent years for their potential health benefits, particularly in relation to gastrointestinal health. One area where probiotics have shown promise is in the management of celiac disease, an autoimmune disorder characterized by the inability to digest gluten. Celiac disease affects millions of people worldwide and can lead to a range of symptoms, including abdominal pain, diarrhea, and malnutrition. While the only treatment for celiac disease is a strict gluten-free diet, research suggests that probiotics may offer additional support in managing the condition. Probiotics are live microorganisms that, when consumed in adequate amounts, confer health benefits to the host. They are believed to modulate the gut microbiota, enhance immune function, and improve intestinal barrier function. In the case of celiac disease, recent studies have shown that certain strains of probiotics, such as Lactobacillus and Bifidobacterium, have the potential to reduce inflammation, promote gut healing, and improve overall digestive health. These probiotics may help alleviate symptoms and improve the overall quality of life for individuals with celiac disease.

**Ingredients:** See Supplement Facts.

**Manufacturer Country:** USA

**Product Amount:** 60 caps

**Gross Weight:** 0.25lb (113g)

**Suggested Use:** Take two (2) capsules once a day as a dietary supplement. For best results, take one (1) capsule during the day and one



### 3. Digestive Enzyme

Digestive enzyme supplements help the body break down proteins, lipids, and carbs to aid digestion and assimilation of nutrients to produce more energy and a healthier life force. Digestive enzymes are responsible for breaking down complex molecules into smaller, more easily absorbable components. In the case of celiacs, digestive enzymes that target gluten could potentially help break down the gluten protein into harmless fragments, reducing the immune response and alleviating symptoms. Several studies have explored the use of digestive enzymes as a supplemental therapy for celiac disease, with promising results. These enzymes, such as gluten-specific proteases, have shown the ability to degrade gluten in laboratory settings. However, it is important to note that digestive enzymes should not be seen as a cure or a substitute for a strict gluten-free diet, which is currently the only effective treatment for celiac disease.

**Ingredients:** see Supplement Facts.

**Manufacturer Country:** USA

**Product Amount:** 60 caps

**Gross Weight:** 0.25lb (133g)

**Suggested Use:** Take one (1) capsule twice a day as a dietary supplement. For best results, take 20-30 min before a meal or as directed by your healthcare professional.

**Caution:** Do not exceed recommended dose. Pregnant or nursing mothers, children under the age of 18, and individuals with a known medical condition should consult a physician before using this or any dietary supplement.

**Warning:** Keep out of reach of children. Do not use if the safety seal is damaged or missing. Store in a cool, dry place.

The Food and Drug Administration has not evaluated these statements. This product is not intended to diagnose, treat, cure or prevent any disease.

**DRSOUS.CA Digestive Enzyme Pro Blend Enhances nutrition absorption, support healthy digestion**

Regular price \$25.00 CAD  
Product Amount: 60 capsules  
Gross Weight: 0.25lb (133g)  
Digestive Enzyme Pro Blend supports those who lack the natural digestive enzymes needed to break down food into nutrients needed for the body.

- Digestive Health
- Increased nutrient uptake
- Improved cardiovascular health

**Supplement Facts**

Serving Size: 1 Capsule (Contains 1 Capsule)	Amount Per Serving	%DV
Lactase (Lactase)	10000 IU	100%
Amylase (Amylase)	10000 IU	100%
Protease (Protease)	10000 IU	100%
Cellulase (Cellulase)	10000 IU	100%
Galactosidase (Galactosidase)	10000 IU	100%
Starchase (Starchase)	10000 IU	100%
Collagenase (Collagenase)	10000 IU	100%
Chitinase (Chitinase)	10000 IU	100%
Phytase (Phytase)	10000 IU	100%
Glucosidase (Glucosidase)	10000 IU	100%
Urease (Urease)	10000 IU	100%
Hexosaminidase (Hexosaminidase)	10000 IU	100%
Disaccharidase (Disaccharidase)	10000 IU	100%
Polysaccharidase (Polysaccharidase)	10000 IU	100%
Enzyme Blend	10000 IU	100%

Paradise Wellness  
A specific channel for Digestive Enzyme Pro Blend on YouTube

Dr. Sous  
www.drsous.ca

### 8. SYSTEMIC LUPUS ERYTHEMATOSUS

Lupus is a disease that occurs when your body's immune system attacks your own tissues and organs (autoimmune disease). Inflammation caused by lupus can affect many different body systems including your joints, skin, kidneys, blood cells, brain, heart and lungs. It is far more common in women (affecting approximately nine women for every man) but men do get lupus. Most women are diagnosed with lupus during childbearing years, but for men the onset of symptoms may occur at any age including childhood.

During puberty, about 25 per cent of people diagnosed with lupus are young men, and in later years, about 20 to 40 per cent of the newly diagnosed lupus patients are men. There are an estimated number of about 5,000 men living with lupus in Canada. Systemic lupus in men can present similarly to lupus in women. This can include skin rashes, pleurisy, fatigue, neurological illnesses such as peripheral neuropathy (inflammation of the nerves in the arms and legs), joint pain, kidney disease, Raynaud's phenomenon and vasculitis (inflammation of the blood vessels). Discoid lupus erythematosus (DLE), which is non-systemic, involves localized skin rashes (coin-shaped scaly lesions generally found on the scalp, face, cheeks and nose). DLE is usually painless, but for some may be quite painful. Patients with DLE may be very photosensitive, and need to limit their sun exposure to reduce lesions and possible scarring. Drug-induced lupus (DILE) Drug-induced lupus is the result of certain medications that cause lupus symptoms such as joint pain,

muscle pain, fever, arthritis and inflammation of the heart and lung. These symptoms can be mild, moderate, or severe. More men develop DILE than women, probably because more men seem to be prescribed medications that produce DILE. The most common drugs that result in drug-induced lupus include medications for heart disease, and high blood pressure. After discontinuing the medication, lupus symptoms gradually disappear, but this may take many days, months or longer to disappear.

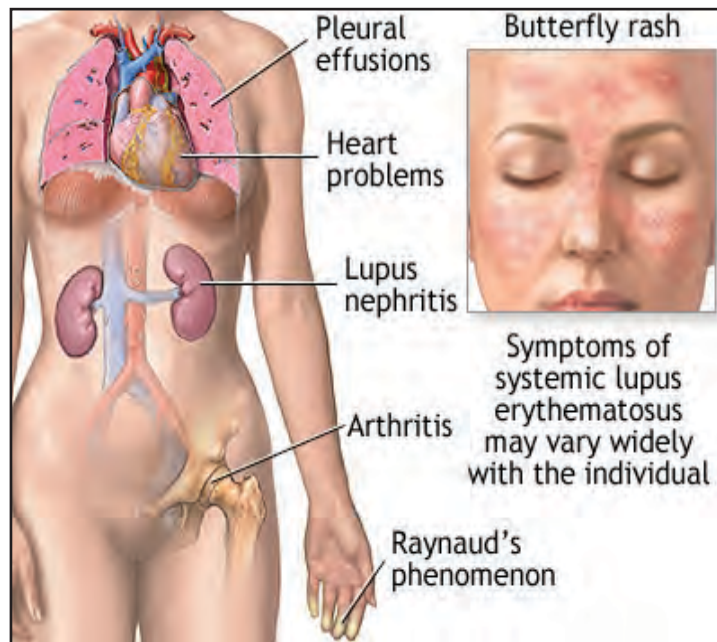

### Diagnosing men with lupus

In order to diagnose lupus there needs to be comprehensive history and physical examination and investigations, such as blood tests. The American College of Rheumatology for research purposes had identified 11 diagnostic criteria some of which pertain to findings in the skin, blood, joints and organs. The presence of at least four of the criteria indicates a diagnosis of SLE by this standard. However, it is possible for a rheumatologist to confirm an SLE diagnosis in some patients, even if the patient does not meet ACR research criteria. Common manifestations include rash, oral ulcers, and inflammatory arthritis. There are other organs that can be involved including the kidneys, lungs and brain.

**Hormones and SLE** It has long been thought that hormones may play a role in the prevalence of lupus in both men and women. Studies have found that:

1. Young men with lupus have been found to have normal levels of Testosterone (a male hormone), however there is some evidence that lower levels of testosterone in both young and older men may predispose these men to autoimmune-like diseases
2. There is no increase of estrogen (a female hormone) in men with lupus. More research is being done on the hormone androgen. It has been found that women with lupus metabolize androgen at a faster rate than women without lupus, and thus have a lower amount of this hormone in their body. This is of interest, as androgens have been shown to have some immunosuppressive properties. As well, researchers want to find out if androgens explain the lower number of men having lupus compared to women.

### # Symptoms

No two cases of lupus are exactly alike. Signs and symptoms may come on suddenly or develop slowly, may be mild or severe, and may be temporary or permanent. Most people with lupus have mild disease characterized by episodes called flares when signs and symptoms get worse for a while, then improve or even disappear completely for a time.

The signs and symptoms of lupus that you experience will depend on which body systems are affected by the disease. The most common signs and symptoms include:

- Fatigue

- Fever
- Joint pain, stiffness and swelling
- Butterfly-shaped rash on the face that covers the cheeks and bridge of the nose or rashes elsewhere on the body
- Skin lesions that appear or worsen with sun exposure
- Fingers and toes that turn white or blue when exposed to cold or during stressful periods
- Shortness of breath
- Chest pain
- Dry eyes
- Headaches, confusion and memory loss

### 1. Platinum Turmeric

Traditional treatment options for SLE often involve the use of immunosuppressive drugs, which can have numerous side effects and may not be effective for all patients. In this context, the potential role of Platinum Turmeric, a natural compound derived from the turmeric plant, has emerged as a promising alternative. Turmeric has long been recognized for its anti-inflammatory and antioxidant properties, thanks to its active ingredient called curcumin. Curcumin is known to inhibit various inflammatory pathways and has been shown to modulate the immune system in preclinical studies. Additionally, curcumin has been found to have a protective effect on the kidneys, which are commonly affected in SLE. The use of Platinum Turmeric in SLE patients is still an area of ongoing research, but preliminary studies have shown promising results. One study published in the Journal of Clinical Immunology demonstrated that curcumin supplementation reduced disease activity and improved quality of life in SLE patients. Another study published in the Journal of Ethnopharmacology found that curcumin inhibited the production of autoantibodies, which play a key role in the development of SLE. These findings suggest that Platinum Turmeric could potentially be used as an adjunct therapy in SLE, either alone or in combination with traditional treatment options.

Our Platinum Turmeric blend contains various forms of turmeric, glucosamine, Boswellia extract (frankincense), piperine, and several other highly beneficial natural extracts to keep you at your best.

Natural extracts have been used for centuries in Ayurvedic medicine to remedy illnesses. We harness and advance these natural extracts in modern times for optimal bioavailability and effectiveness.

**Ingredients:** see Supplement Facts.

**Manufacturer Country:** USA

**Product Amount:** 60 caps

**Gross Weight:** 0.25lb (113g)

**Suggested Use:** Take two (2) capsules once a day as a dietary supplement. For best results, take 20-30 min before a meal or as directed by your healthcare professional.

**DrSous.ca Platinum Turmeric 60**  
**Capsule Bottle**  
 Regular price: \$20.00 CAD  
 Product Amount: 60 caps  
 Gross Weight: 0.25lb (113g)

Our Platinum Turmeric blend contains various forms of turmeric, glucosamine, Boswellia extract (frankincense), piperine, and several other highly beneficial natural extracts to keep you at your best.

- Anti-inflammatory
- Joint and bone health
- Heart Protective
- Anti-oxidant & Anti- Cancer

**Supplement Facts**  
 Serving Size: 2 Capsules  
 Amount Per Serving

	Amount Per Serving	% Daily Value
100% Pure Turmeric (Curcumin)	1000mg	100%
100% Pure Boswellia Extract (Boswellic Acids)	1000mg	100%
100% Pure Piperine (Black Pepper)	1000mg	100%
100% Pure Glucosamine HCL	1000mg	100%
100% Pure MSM (Methylsulfonylmethane)	1000mg	100%
100% Pure Vitamin C	1000mg	100%
100% Pure Vitamin E	1000mg	100%
100% Pure Omega-3 Fatty Acids	1000mg	100%
100% Pure Zinc	1000mg	100%
100% Pure Selenium	1000mg	100%
100% Pure Magnesium	1000mg	100%
100% Pure Calcium	1000mg	100%
100% Pure Potassium	1000mg	100%
100% Pure Sodium	1000mg	100%
100% Pure Chloride	1000mg	100%
100% Pure Phosphate	1000mg	100%
100% Pure Magnesium	1000mg	100%
100% Pure Zinc	1000mg	100%
100% Pure Selenium	1000mg	100%
100% Pure Magnesium	1000mg	100%
100% Pure Zinc	1000mg	100%
100% Pure Selenium	1000mg	100%
100% Pure Magnesium	1000mg	100%
100% Pure Zinc	1000mg	100%
100% Pure Selenium	1000mg	100%

Other Ingredients: Cellulose, Hydroxypropyl Cellulose, Magnesium Stearate, Polyethylene Glycol, Stearic Acid, Titanium Dioxide, and Water.

© 2018 Dr. Sous. All rights reserved.

Paradise Wellness  
 A specific channel for Platinum Turmeric on YouTube

Dr. Sous | www.drsous.ca



## 2. Vitamin D3

Vitamin D3, also known as cholecalciferol, is a hormone-like substance that is synthesized in the skin upon exposure to sunlight or obtained from dietary sources. It is well-known for its crucial role in calcium and phosphate metabolism, helping maintain bone health. However, recent studies have shown that Vitamin D3 also possesses immunomodulatory properties, meaning it can regulate the immune system's response. In the context of SLE, where the immune system is dysregulated, Vitamin D3 has shown promise in reducing disease activity and improving overall outcomes. Several mechanisms explain the potential benefits of Vitamin D3 in SLE. Firstly, it has been found to suppress the production of autoantibodies and pro-inflammatory cytokines, thereby reducing inflammation and tissue damage. Additionally, Vitamin D3 facilitates the development and function of regulatory T cells, which help control the immune response and prevent excessive inflammation. Moreover, Vitamin D3 has been shown to have a positive impact on the kidneys, a commonly affected organ in SLE, by reducing proteinuria and maintaining renal function.

**Ingredients:** see Supplement Facts.

**Manufacturer Country:** USA

**Product Amount:** 100 soft-gels

**Gross Weight:** 0.1lb (45g)

**Suggested Use:** As a dietary supplement, adults take one (1) soft-gel capsule daily or as directed by a health care professional. Store in a cool, dry place and away from direct light.



## 3. CoQ10

CoQ10 Ubiquinone is a naturally occurring compound found in every cell of the body and plays a crucial role in energy production. It acts as an antioxidant, protecting cells from oxidative stress and reducing inflammation. Studies have shown that individuals with SLE often have reduced levels of CoQ10, leading to speculation that supplementation could be beneficial. Preliminary research suggests that CoQ10 supplementation may help alleviate some of the symptoms associated with SLE, such as fatigue, muscle pain, and joint inflammation. Additionally, it has been proposed that CoQ10 may have immunomodulatory effects, helping to regulate the overactive immune response seen in SLE.

**Ingredients:** see Supplement Facts.

**Manufacturer Country:** USA

**Product Amount:** 30 caps

**Gross Weight:** 0.25lb (113g)

**Suggested Use:** Take one (1) capsule twice a day as a dietary supplement. For best results, take 20-30 min before a meal or as directed by your healthcare professional.

**Caution:** Do not exceed recommended dose. Pregnant or nursing mothers, children under the age of 18, and individuals with a known

medical condition should consult a physician before using this or any dietary supplement.

Warning: Keep out of reach of children. Do not use if the safety seal is damaged or missing. Store in a cool, dry place.

The Food and Drug Administration has not evaluated these statements. This product is not intended to diagnose, treat, cure or prevent any disease.



## 9. TO IMPROVE IMMUNITY

Your immune system helps you heal and stay well. To work well your immune system needs healthful foods, exercise and low stress. But, be careful because too much of an inflammatory response can lead to chronic (long term) illnesses such as diabetes, heart disease and some cancers. So how can you support your immune system and balance its response so you get and stay healthy?

**Here are six healthy living strategies you can use to boost your immune system:**

1. drink plenty of fluids
2. exercise regularly
3. limit stress
4. get plenty of sleep
5. include probiotics from foods or supplements
6. Eat a colorful, well-balanced diet.

**You can also add some supplements in your diet to boost your immunity:** like bee pearl pollen nectar enzyme, Platinum Turmeric, & Reishi Mushroom.

### 1. Bee Pearl pollen nectar enzyme

Bee pollen, often referred to as nature's superfood, is a powerhouse of essential nutrients that can significantly boost immunity. This remarkable substance is collected by bees from the male reproductive parts of flowers and then mixed with nectar and enzymes to create bee pollen. Packed with vitamins, minerals, and antioxidants, bee pollen offers a wide range of health benefits. Its immune-boosting properties can be attributed to its high vitamin C content, which helps stimulate the production of white blood cells, vital for fighting off infections and diseases. Additionally, bee pollen contains numerous enzymes that aid in digestion and promote the absorption of nutrients, ensuring that our bodies receive the maximum benefits from the foods we eat. Moreover, the presence of natural antibiotics in bee pollen can help combat harmful bacteria and viruses, further strengthening our immune system. Regular consumption of bee pollen has also been shown to reduce inflammation, improve allergies, and enhance overall vitality. In conclusion, incorporating bee pollen into our daily diet can provide us with an abundance of immunity-boosting nutrients, making it an excellent natural remedy for maintaining optimal health and well-being.

**Ingredients:** see Supplement Facts.

**Manufacturer Country:** Latvia

**Product Amount:** 30 caps

**Gross Weight:** 0.11lb (50g)

**Suggested Use:** One (1) capsule per day during the main meal or immediately after it with a glass of water. Suitable for vegetarians.

**Caution:** Recommended to anyone who is not allergic to bee products. If you are prone to allergic reactions, consult a doctor or pharmacist before use. Do not exceed the recommended daily dose. Do not use on an empty stomach. Consult a doctor or pharmacist before using this product during pregnancy or when breastfeeding. Do not use after the expiry of the validity period. Do not use food supplements as a substitute for a diverse and balanced diet. Keep out of reach and sight of children. Store at room temperature from +15C to +25C in a dry place, away from direct sunlight.

**Warning:** This product is not intended to diagnose, treat, cure or prevent any disease. Do not use if the safety seal is damaged or missing. Store in a cool, dry place.

The Food and Drug Administration has not evaluated these statements. This product is not intended to diagnose, treat, cure or prevent any dis



## 2. Platinum Turmeric

Platinum Turmeric is a remarkable natural remedy that has gained significant attention in recent years for its potential to boost immunity. Turmeric, a vibrant golden spice, has long been used in traditional medicine for its medicinal properties. However, Platinum Turmeric takes it a step further by harnessing the power of curcumin, the active compound found in turmeric, to enhance immune function. Curcumin is known for its potent antioxidant and anti-inflammatory properties, which play a crucial role in supporting the body's defense mechanisms. By reducing oxidative stress and inflammation, Platinum Turmeric helps strengthen the immune system, enabling it to better fight off pathogens and protect against various diseases. Furthermore, Platinum Turmeric's immune-boosting effects are not limited to just curcumin. This innovative supplement is often formulated with other immune-supporting ingredients like black pepper extract, which enhances curcumin absorption, and ginger, which has its own immune-boosting properties. Platinum Turmeric offers a convenient and effective way to incorporate the benefits of turmeric into one's daily routine, providing a natural and holistic approach to enhancing immunity. Whether it is used as a preventive measure or as a support during times of illness, Platinum Turmeric has become a trusted ally in promoting overall health and well-being.

**Ingredients:** see Supplement Facts.

**Manufacturer Country:** USA

**Product Amount:** 60 caps

**Gross Weight:** 0.25lb (113g)

**Suggested Use:** Take two (2) capsules once a day as a dietary supplement. For best results, take 20-30 min before a meal or as directed by your healthcare professional.



## 10. GRAVES DISEASE

Graves' disease is an autoimmune disorder that can cause hyperthyroidism, or overactive thyroid. The thyroid is a small, butterfly-shaped gland in the front of your neck. Thyroid hormones control the way your body uses energy, so they affect nearly every organ in your body, even the way your heart beats. Graves disease is the most common cause of hyperthyroidism. It is due to an abnormal immune system response that causes the thyroid gland to produce too much thyroid hormone. Graves disease is most common in women over age 20. But the disorder can occur at any age and can affect men as well. With Graves' disease, your immune system attacks your thyroid gland, causing it to make more thyroid hormones than your body needs. As a result, many of your body's functions speed up. The thyroid is a small gland in your neck that makes thyroid hormones.

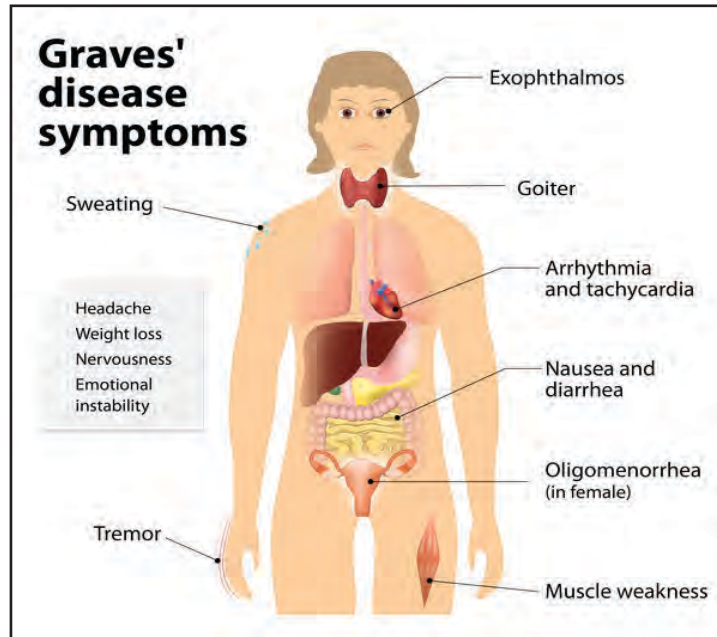

Some foods may exacerbate Graves' disease symptoms. Food sensitivities or allergies may negatively impact the immune system, causing disease flares in some people.

### What are the symptoms of Graves' disease?

- weight loss, despite an increased appetite
- rapid or irregular heartbeat
- nervousness, irritability, trouble sleeping, fatigue
- shaky hands, muscle weakness
- sweating or trouble tolerating heat
- frequent bowel movements
- an enlarged thyroid gland, called a goiter

**The recommended supplements for graves disease are:** Vitamin D3, Ashwagandha, & Platinum Turmeric.

### 1. Vitamin D3

Vitamin D3, also known as the sunshine vitamin, has gained significant attention in recent years for its potential benefits in managing various health conditions, including Graves' disease. Graves' disease is an autoimmune disorder characterized by an overactive thyroid gland, leading to symptoms such as weight loss, irritability, tremors, and bulging eyes. While the primary treatment for Graves' disease typically involves medications that suppress the excessive thyroid hormone production or, in severe cases, radioactive iodine therapy or surgery, emerging research suggests that vitamin D3 may play a complementary role in managing the condition. Several studies have explored the relationship between vitamin D3 levels and Graves' disease, with promising results. Vitamin D3 is involved in modulating

the immune system and has been found to have anti-inflammatory properties. Since Graves' disease is an autoimmune disorder, where the immune system mistakenly attacks the thyroid gland, it is believed that vitamin D3 could potentially help regulate the immune response and reduce inflammation. One study published in the Journal of Clinical Endocrinology and Metabolism found that individuals with Graves' disease had significantly lower levels of vitamin D3 compared to healthy controls. The researchers observed that supplementing with vitamin D3 led to a reduction in thyroid-stimulating hormone (TSH) levels, which is typically elevated in Graves' disease. Furthermore, vitamin D3 supplementation was associated with improved thyroid function and a decrease in autoantibodies, which are antibodies that target the thyroid gland. Another study conducted at the University of California, San Francisco, examined the effect of vitamin D3 supplementation on thyroid function in individuals with Graves' disease. The results showed that vitamin D3 supplementation led to a significant decrease in TSH levels, suggesting improved thyroid function. Additionally, the study found that vitamin D3 supplementation was associated with a decrease in thyroid autoantibodies, indicating a potential benefit in reducing the autoimmune response.

**Ingredients:** see Supplement Facts.

**Manufacturer Country:** USA

**Product Amount:** 100 soft-gels

**Gross Weight:** 0.1lb (45g)

**Suggested Use:** As a dietary supplement, adults take one (1) soft-gel capsule daily or as directed by a health care professional. Store in a cool, dry place and away from direct light.



## 2. Ashwagandha

Ashwagandha, a popular herb in traditional Ayurvedic medicine, has gained attention for its potential therapeutic effects on various health conditions, including Graves' disease. Graves' disease is an autoimmune disorder characterized by an overactive thyroid gland, leading to symptoms such as weight loss, rapid heartbeat, anxiety, and fatigue. Ashwagandha, scientifically known as *Withania somnifera*, has been extensively studied for its adaptogenic properties, which help the body cope with stress and maintain overall well-being. One of the main active compounds in ashwagandha, called withanolides, has been found to possess anti-inflammatory and immune-modulating properties. These properties make ashwagandha a promising natural supplement for managing Graves' disease symptoms and potentially supporting thyroid health. Research suggests that ashwagandha may help modulate the immune system, reducing the production of thyroid-stimulating antibodies that contribute to the hyperactivity of the thyroid gland in Graves' disease. Additionally, ashwagandha has been shown to have a calming effect on the nervous system, helping to alleviate anxiety and stress-related symptoms commonly associated with Graves' disease.

**Ingredients:** see Supplement facts.

**Manufacturer Country:** USA



## 11. HASHIMOTO'S THYROIDITIS

Hashimoto's disease or Hashimoto's thyroiditis is a condition that leads to hypothyroidism. This occurs when the butterfly-shaped thyroid gland in the front of the neck is unable to produce enough thyroid hormones, causing the bodily functions to slow down. These hormones regulate metabolism, muscle strength, body temperature, and many other vital processes. Hashimoto's disease is the most common cause of hypothyroidism. Low thyroid function can cause weight gain, lower cardiac fitness, and irregular heart rhythms. It is almost always painless but makes swallowing difficult. Most people with this condition require treatment.

Hashimoto's disease is considered an autoimmune disorder. The role of the immune system is to protect the body from outside invaders, such as germs and environmental substances. Instead, the immune system turns against the body itself, attacking glands, joints, the liver, blood cells, and more. In people with Hashimoto's disease, white blood cells and antibodies from the immune system attack the thyroid gland and cause it to decrease the output of hormones. Experts believe susceptibility for this illness runs in families. A prior history of another autoimmune disorder, such as rheumatoid arthritis, vitiligo, or lupus raises the risk of developing Hashimoto's disease.

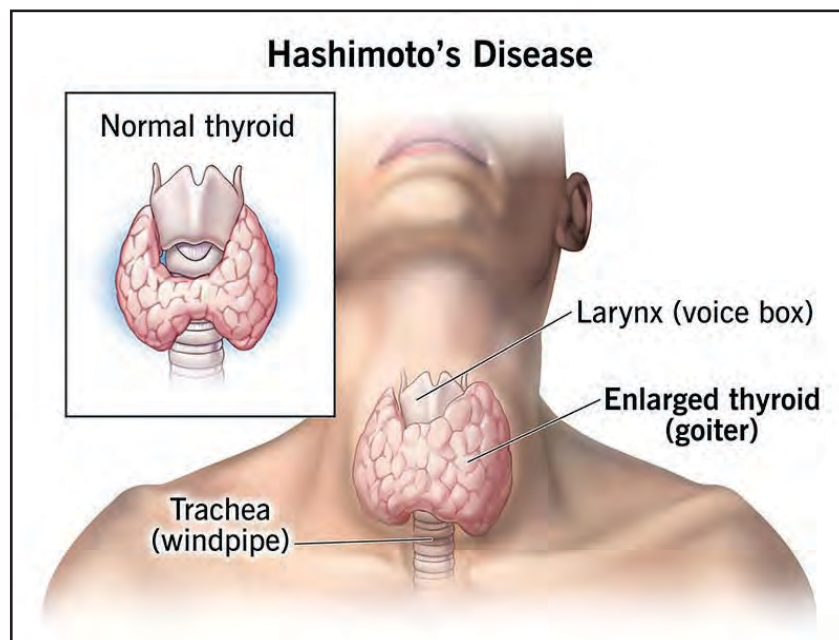

### # Symptoms

- fatigue
- weight gain
- trouble tolerating cold
- joint and muscle pain
- constipation
- dry skin or dry, thinning hair
- heavy or irregular menstrual periods or fertility problems
- slowed heart rate

**The recommended supplement for Hashimoto's disease are:** Probiotic, B-12 Drops, & CoQ10 Ubiquinone.

### 1. Probiotics

Probiotics have gained significant attention in the medical field for their potential health benefits. One area where they are being increasingly explored is in the management of Hashimoto's disease. Hashimoto's disease, also known as chronic lymphocytic thyroiditis, is an autoimmune disorder characterized by an underactive thyroid gland. It is caused by the immune system mistakenly attacking the thyroid tissue, leading to inflammation and impaired hormone production. Probiotics, which are live bacteria and yeasts that are beneficial to our health, have been studied for their potential to modulate the immune system and reduce inflammation. By promoting



a healthy balance of gut bacteria, probiotics may help regulate the immune response in individuals with Hashimoto's disease. Research suggests that certain strains of probiotics, such as Lactobacillus and Bifidobacterium, have the potential to improve thyroid function and reduce autoimmune activity. These beneficial bacteria can promote the production of short-chain fatty acids, which have anti-inflammatory properties and can help restore gut barrier function. Furthermore, probiotics may also enhance the absorption of thyroid hormone replacement medication, which is commonly prescribed to manage Hashimoto's disease.

**Ingredients:** See Supplement Facts.

**Manufacturer Country:** USA

**Product Amount:** 60 caps

**Gross Weight:** 0.25lb (113g)

**Suggested Use:** Take two (2) capsules once a day as a dietary supplement. For best results, take one (1) capsule during the day and one (1) capsule in the evening. Repeat the process daily. Do not exceed two capsules per day.

**Warning:** Keep out of reach of children. Do not use if the safety seal is damaged or missing. Store in a cool, dry place.

**DrSous.Ca Probiotic 40 Billion with Prebiotics**  
 Regular price: \$27.00 CAD  
 Product Amount: 60 caps  
 Gross Weight: 0.25lb (113g)

Probiotic 40 Billion with Prebiotics is a blend of four probiotic strains: Lactobacillus Acidophilus, Bifidobacterium Lactis, Lactobacillus Plantarum, and Lactobacillus Paracasei. Together, they provide a high level of beneficial bacteria to the gut to support a healthy metabolic response for both men and women.

**Supplement Facts**  
 Serving Size: 2 Capsules  
 Servings Per Container: 30

	Amount Per Serving	%DV
Proprietary Blend of Probiotic Strains	40 Billion CFU	100%
MAX-BE-BE-Pre-Prebiotics	100mg	100%
Lactobacillus Acidophilus	10-40	
Bifidobacterium Lactis	20-90	
Lactobacillus Plantarum	10-100	
Lactobacillus Paracasei	100-200	
Mixed Polysaccharide Complex	100-200	
Hydroxyphenyl Ether		

Other Ingredients: Cellulose, Hydroxyphenyl Ether, Ribonucleotides, L-Cysteine

Dr. Sous | www.drsous.ca

## 2. B-12 Drops

Vitamin B-12, also known as cobalamin, plays a crucial role in the body's metabolism, energy production, and neurological function. However, individuals with Hashimoto's disease may have difficulty absorbing and utilizing B-12 due to digestive issues and inflammation. B-12 drops, which are easily absorbed under the tongue, bypass the digestive system and deliver the essential vitamin directly into the bloodstream. By supplementing with B-12 drops, individuals with Hashimoto's disease can potentially alleviate some of the symptoms associated with the condition. B-12 drops may help combat fatigue and improve energy levels, support cognitive function and mental clarity, and contribute to a healthy metabolism. It is important to note that B-12 drops should not replace standard medical treatment for Hashimoto's disease, but rather be used as a complementary approach to support overall health and well-being.

**B-12 Drops**

B12 complex contains: Riboflavin-required for the proper development and function of the skin, lining of the digestive tract, Niacin-required for the proper function of fats and sugars in the body and to maintain healthy tissue, Vitamin B6-needed to maintain proper energy levels. B12 is a critical vitamin that is required for proper development of many body systems and tissues. Deficiency of B12 can lead to many problems such as memory loss and fatigue.

Dr. Sous | www.drsous.ca

### 3. CoQ10

CoQ10, also known as coenzyme Q10, is a naturally occurring compound found in almost every cell of the human body. It plays a crucial role in cellular energy production and acts as a powerful antioxidant, protecting cells from oxidative damage. Hashimoto's disease, an autoimmune disorder that causes inflammation of the thyroid gland, can lead to a variety of symptoms such as fatigue, weight gain, and depression. Although CoQ10 is not a cure for Hashimoto's disease, it has shown potential in providing some relief for individuals suffering from this condition. Several studies have suggested that CoQ10 supplementation may help improve thyroid function and reduce inflammation in individuals with Hashimoto's disease. By increasing cellular energy production, CoQ10 may enhance the overall function of the thyroid gland, which is responsible for regulating metabolism and hormone production. Additionally, its antioxidant properties can help reduce oxidative stress, which is commonly observed in individuals with Hashimoto's disease.

**Ingredients:** see Supplement Facts.

**Manufacturer Country:** USA

**Product Amount:** 30 caps

**Gross Weight:** 0.25lb (113g)

**Suggested Use:** Take one (1) capsule twice a day as a dietary supplement. For best results, take 20-30 min before a meal or as directed by your healthcare professional.

**Caution:** Do not exceed recommended dose. Pregnant or nursing mothers, children under the age of 18, and individuals with a known medical condition should consult a physician before using this or any dietary supplement.

**Warning:** Keep out of reach of children. Do not use if the safety seal is damaged or missing. Store in a cool, dry place.

The Food and Drug Administration has not evaluated these statements. This product is not intended to diagnose, treat, cure or prevent any disease.



## 12. INFLAMMATORY BOWEL DISEASE

Inflammatory bowel disease (IBD) is a group of disorders that cause chronic inflammation (pain and swelling) in the intestines. IBD includes Crohn's disease and ulcerative colitis. Both types affect the digestive system. Treatments can help manage this lifelong condition.

### What are the types of IBD?

Crohn's disease and ulcerative colitis are the main types of IBD. Types include:

- **Crohn's disease** causes pain and swelling in the digestive tract. It can affect any part from the mouth to the anus. It most commonly affects the small intestine and upper part of the large intestine.
- **Ulcerative colitis** causes swelling and sores (ulcers) in the large intestine (colon and rectum).
- **Microscopic colitis** causes intestinal inflammation that's only detectable with a microscope.

What's the difference between inflammatory bowel disease (IBD) and irritable bowel syndrome (IBS)?

IBD is a disease; IBS is a syndrome, or group of symptoms. The causes and treatments are different. IBS is a type of functional gastrointestinal disease. It affects how the bowels function, causing them to contract more (or sometimes less) often than usual. IBS is also known as spastic colon or nervous stomach.

### # Symptoms

The common symptoms of IBD are fever, abdominal pain, and diarrhea. There are other symptoms as well which manifest according to where the lesions are. These symptoms include kidney stones, weight loss, fat or blood loss in the stool and more. Usually, symptoms would appear when you're stressed then go away for some time. So it's quite difficult for people to realize that they're already suffering from IBD. Right now, genetic predisposition is frequently thought to be the primary cause of inflammatory bowel disease. This means that specific people may respond differently to certain infections. Apparently, though, there's a particular bug which causes them, and it's already living in the bowels of the person. In fact, our guts house more bugs or microbes than the cells in the whole body. It may be possible that a person's diet may contribute to or trigger IBD. It may even be possible that specific foods promote the overgrowth of the particular microbes in the bowel which cause the disease. However, there's no evidence to prove that a specific kind of diet may support the appearance of the microbe which causes IBD. Symptoms of irritable bowel syndrome include bloating, excess gas, changes in the patterns of bowel movements, pain in the lower abdomen and mucus in the stool. A diagnosis of IBS is more likely when these symptoms persist for at least six months. The signs of IBS tend to vary for everyone. The most typical symptoms are abdominal pain and cramping. Bloating and excess gas are other signs of IBS. Some people also experience diarrhea or constipation, and it's also possible to go back and forth between the two. Mucus in the stool is another sign of IBS. It's typical for people with IBS to experience symptoms that go from mild to severe and then back again.

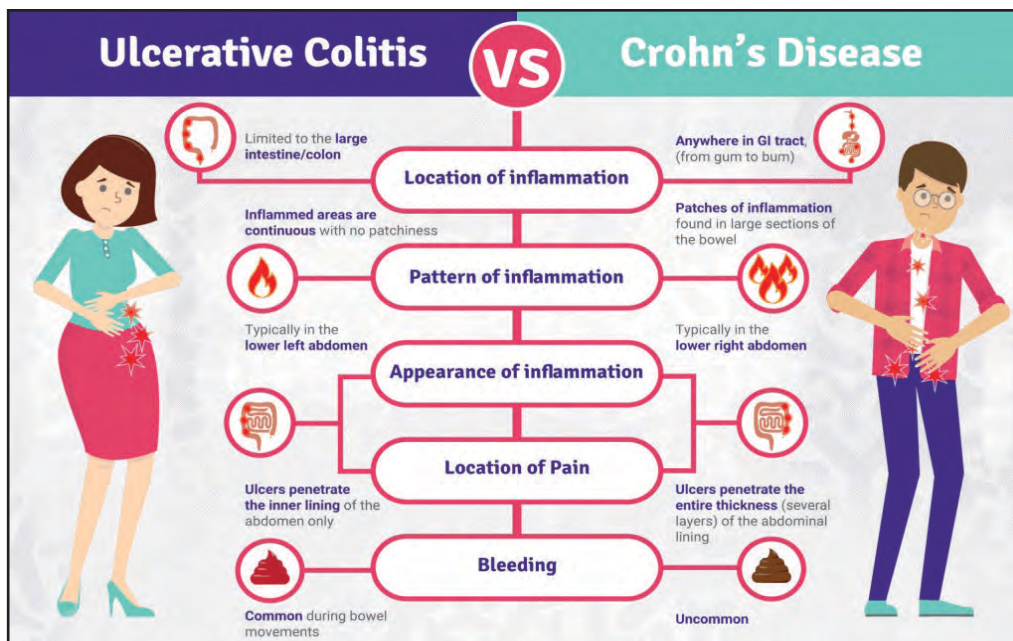

**The recommended supplement for IBS/ IBD are:** Platinum Turmeric, Vitamin D3, & L-Glutamine Powder.

### 1. Platinum Turmeric

Platinum Turmeric for IBD, also known as Inflammatory Bowel Disease, has gained significant attention in recent years as a potential natural remedy for managing the symptoms of this chronic condition. IBD, which includes Crohn's disease and ulcerative colitis, is characterized by inflammation in the digestive tract, leading to symptoms such as abdominal pain, diarrhea, fatigue, and weight loss. Traditional treatments for IBD often involve medications that suppress the immune system, but they can come with side effects and may not be effective for everyone. Platinum Turmeric, on the other hand, offers a promising alternative with its natural anti-inflammatory properties. Turmeric, a spice derived from the *Curcuma longa* plant, contains a compound called curcumin, which has been

shown to have powerful anti-inflammatory and antioxidant effects. These properties make Platinum Turmeric an attractive option for IBD patients, as it may help reduce inflammation in the gut and alleviate the symptoms associated with the condition. Furthermore, Platinum Turmeric has been found to modulate the immune system, which is crucial in managing IBD. It can help regulate the production of cytokines, which are small proteins involved in inflammation. By balancing the immune response, Platinum Turmeric may contribute to a reduction in flare-ups and promote overall gut health. Additionally, Platinum Turmeric has been studied for its potential to support gut microbiota, the community of microorganisms in our digestive system. Dysbiosis, an imbalance in gut bacteria, is commonly observed in IBD patients and can worsen the symptoms. Platinum Turmeric has shown antimicrobial properties against harmful bacteria while promoting the growth of beneficial strains. This dual action may help restore the balance of gut microbiota and improve the overall health of the digestive system. Our Platinum Turmeric blend contains various forms of turmeric, glucosamine, Boswellia extract (frankincense), piperine, and several other highly beneficial natural extracts to improve its absorption and to keep you at your best. Natural extracts have been used for centuries in Ayurvedic medicine to remedy illnesses. We harness and advance these natural extracts in modern times for optimal bioavailability and effectiveness.

**Ingredients:** see Supplement Facts.

**Manufacturer Country:** USA

**Product Amount:** 60 caps

**Gross Weight:** 0.25lb (113g)

**Suggested Use:** Take two (2) capsules once a day as a dietary supplement. For best results, take 20-30 min before a meal or as directed by your healthcare professional.

**DrSous.ca Platinum Turmeric 60 Capsule Bottle**  
 Regular price: \$20.00 CAD  
 Product Amount: 60 caps  
 Gross Weight: 0.25lb (113g)  
 Our Platinum Turmeric blend contains various forms of turmeric, glucosamine, Boswellia extract (frankincense), piperine, and several other highly beneficial natural extracts to keep you at your best.

- Anti-inflammatory
- Joint and bone health
- Heart Protection
- Anti-oxidant & Anti-Cancer

**Supplement Facts**  
 Serving Size: 2 Capsules (1g)  
 Amount Per Serving %DV

	Amount Per Serving	%DV
Platinum Turmeric Blend	1000mg	100%
Glucosamine HCl	500mg	100%
Boswellia Extract	500mg	100%
Piperine	500mg	100%
Curcumin	500mg	100%
Black Pepper	500mg	100%
Garlic	500mg	100%
Green Tea	500mg	100%
Omega-3 Fatty Acids	500mg	100%
Chondroitin Sulfate	500mg	100%
MSM	500mg	100%
Collagen	500mg	100%
Hydrolyzed Collagen	500mg	100%
Unflavored Gelatin	500mg	100%
Plantain	500mg	100%
Marshmallow Root	500mg	100%
Yucca	500mg	100%
Apple Cider Vinegar	500mg	100%
Apple Pectin	500mg	100%
Apple Juice Concentrate	500mg	100%
Apple Fiber	500mg	100%
Apple Cider Vinegar	500mg	100%
Apple Pectin	500mg	100%
Apple Juice Concentrate	500mg	100%
Apple Fiber	500mg	100%
Apple Cider Vinegar	500mg	100%
Apple Pectin	500mg	100%
Apple Juice Concentrate	500mg	100%
Apple Fiber	500mg	100%
Apple Cider Vinegar	500mg	100%
Apple Pectin	500mg	100%
Apple Juice Concentrate	500mg	100%
Apple Fiber	500mg	100%
Apple Cider Vinegar	500mg	100%
Apple Pectin	500mg	100%
Apple Juice Concentrate	500mg	100%
Apple Fiber	500mg	100%
Apple Cider Vinegar	500mg	100%
Apple Pectin	500mg	100%
Apple Juice Concentrate	500mg	100%
Apple Fiber	500mg	100%
Apple Cider Vinegar	500mg	100%
Apple Pectin	500mg	100%
Apple Juice Concentrate	500mg	100%
Apple Fiber	500mg	100%
Apple Cider Vinegar	500mg	100%
Apple Pectin	500mg	100%
Apple Juice Concentrate	500mg	100%
Apple Fiber	500mg	100%
Apple Cider Vinegar	500mg	100%
Apple Pectin	500mg	100%
Apple Juice Concentrate	500mg	100%
Apple Fiber	500mg	100%
Apple Cider Vinegar	500mg	100%
Apple Pectin	500mg	100%
Apple Juice Concentrate	500mg	100%
Apple Fiber	500mg	100%
Apple Cider Vinegar	500mg	100%
Apple Pectin	500mg	100%
Apple Juice Concentrate	500mg	100%
Apple Fiber	500mg	100%
Apple Cider Vinegar	500mg	100%
Apple Pectin	500mg	100%
Apple Juice Concentrate	500mg	100%
Apple Fiber	500mg	100%
Apple Cider Vinegar	500mg	100%
Apple Pectin	500mg	100%
Apple Juice Concentrate	500mg	100%
Apple Fiber	500mg	100%
Apple Cider Vinegar	500mg	100%
Apple Pectin	500mg	100%
Apple Juice Concentrate	500mg	100%
Apple Fiber	500mg	100%
Apple Cider Vinegar	500mg	100%
Apple Pectin	500mg	100%
Apple Juice Concentrate	500mg	100%
Apple Fiber	500mg	100%
Apple Cider Vinegar	500mg	100%
Apple Pectin	500mg	100%
Apple Juice Concentrate	500mg	100%
Apple Fiber	500mg	100%
Apple Cider Vinegar	500mg	100%
Apple Pectin	500mg	100%
Apple Juice Concentrate	500mg	100%
Apple Fiber	500mg	100%
Apple Cider Vinegar	500mg	100%
Apple Pectin	500mg	100%
Apple Juice Concentrate	500mg	100%
Apple Fiber	500mg	100%
Apple Cider Vinegar	500mg	100%
Apple Pectin	500mg	100%
Apple Juice Concentrate	500mg	100%
Apple Fiber	500mg	100%
Apple Cider Vinegar	500mg	100%
Apple Pectin	500mg	100%
Apple Juice Concentrate	500mg	100%
Apple Fiber	500mg	100%
Apple Cider Vinegar	500mg	100%
Apple Pectin	500mg	100%
Apple Juice Concentrate	500mg	100%
Apple Fiber	500mg	100%
Apple Cider Vinegar	500mg	100%
Apple Pectin	500mg	100%
Apple Juice Concentrate	500mg	100%
Apple Fiber	500mg	100%
Apple Cider Vinegar	500mg	100%
Apple Pectin	500mg	100%
Apple Juice Concentrate	500mg	100%
Apple Fiber	500mg	100%
Apple Cider Vinegar	500mg	100%
Apple Pectin	500mg	100%
Apple Juice Concentrate	500mg	100%
Apple Fiber	500mg	100%
Apple Cider Vinegar	500mg	100%
Apple Pectin	500mg	100%
Apple Juice Concentrate	500mg	100%
Apple Fiber	500mg	100%
Apple Cider Vinegar	500mg	100%
Apple Pectin	500mg	100%
Apple Juice Concentrate	500mg	100%
Apple Fiber	500mg	100%
Apple Cider Vinegar	500mg	100%
Apple Pectin	500mg	100%
Apple Juice Concentrate	500mg	100%
Apple Fiber	500mg	100%
Apple Cider Vinegar	500mg	100%
Apple Pectin	500mg	100%
Apple Juice Concentrate	500mg	100%
Apple Fiber	500mg	100%
Apple Cider Vinegar	500mg	100%
Apple Pectin	500mg	100%
Apple Juice Concentrate	500mg	100%
Apple Fiber	500mg	100%
Apple Cider Vinegar	500mg	100%
Apple Pectin	500mg	100%
Apple Juice Concentrate	500mg	100%
Apple Fiber	500mg	100%
Apple Cider Vinegar	500mg	100%
Apple Pectin	500mg	100%
Apple Juice Concentrate	500mg	100%
Apple Fiber	500mg	100%
Apple Cider Vinegar	500mg	100%
Apple Pectin	500mg	100%
Apple Juice Concentrate	500mg	100%
Apple Fiber	500mg	100%
Apple Cider Vinegar	500mg	100%
Apple Pectin	500mg	100%
Apple Juice Concentrate	500mg	100%
Apple Fiber	500mg	100%
Apple Cider Vinegar	500mg	100%
Apple Pectin	500mg	100%
Apple Juice Concentrate	500mg	100%
Apple Fiber	500mg	100%
Apple Cider Vinegar	500mg	100%
Apple Pectin	500mg	100%
Apple Juice Concentrate	500mg	100%
Apple Fiber	500mg	100%
Apple Cider Vinegar	500mg	100%
Apple Pectin	500mg	100%
Apple Juice Concentrate	500mg	100%
Apple Fiber	500mg	100%
Apple Cider Vinegar	500mg	100%
Apple Pectin	500mg	100%
Apple Juice Concentrate	500mg	100%
Apple Fiber	500mg	100%
Apple Cider Vinegar	500mg	100%
Apple Pectin	500mg	100%
Apple Juice Concentrate	500mg	100%
Apple Fiber	500mg	100%
Apple Cider Vinegar	500mg	100%
Apple Pectin	500mg	100%
Apple Juice Concentrate	500mg	100%
Apple Fiber	500mg	100%
Apple Cider Vinegar	500mg	100%
Apple Pectin	500mg	100%
Apple Juice Concentrate	500mg	100%
Apple Fiber	500mg	100%
Apple Cider Vinegar	500mg	100%
Apple Pectin	500mg	100%
Apple Juice Concentrate	500mg	100%
Apple Fiber	500mg	100%
Apple Cider Vinegar	500mg	100%
Apple Pectin	500mg	100%
Apple Juice Concentrate	500mg	100%
Apple Fiber	500mg	100%
Apple Cider Vinegar	500mg	100%
Apple Pectin	500mg	100%
Apple Juice Concentrate	500mg	100%
Apple Fiber	500mg	100%
Apple Cider Vinegar	500mg	100%
Apple Pectin	500mg	100%
Apple Juice Concentrate	500mg	100%
Apple Fiber	500mg	100%
Apple Cider Vinegar	500mg	100%
Apple Pectin	500mg	100%
Apple Juice Concentrate	500mg	100%
Apple Fiber	500mg	100%
Apple Cider Vinegar	500mg	100%
Apple Pectin	500mg	100%
Apple Juice Concentrate	500mg	100%
Apple Fiber	500mg	100%
Apple Cider Vinegar	500mg	100%
Apple Pectin	500mg	100%
Apple Juice Concentrate	500mg	100%
Apple Fiber	500mg	100%
Apple Cider Vinegar	500mg	100%
Apple Pectin	500mg	100%
Apple Juice Concentrate	500mg	100%
Apple Fiber	500mg	100%
Apple Cider Vinegar	500mg	100%
Apple Pectin	500mg	100%
Apple Juice Concentrate	500mg	100%
Apple Fiber	500mg	100%
Apple Cider Vinegar	500mg	100%
Apple Pectin	500mg	100%
Apple Juice Concentrate	500mg	100%
Apple Fiber	500mg	100%
Apple Cider Vinegar	500mg	100%
Apple Pectin	500mg	100%
Apple Juice Concentrate	500mg	100%
Apple Fiber	500mg	100%
Apple Cider Vinegar	500mg	100%
Apple Pectin	500mg	100%
Apple Juice Concentrate	500mg	100%
Apple Fiber	500mg	100%
Apple Cider Vinegar	500mg	100%
Apple Pectin	500mg	100%
Apple Juice Concentrate	500mg	100%
Apple Fiber	500mg	100%
Apple Cider Vinegar	500mg	100%
Apple Pectin	500mg	100%
Apple Juice Concentrate	500mg	100%
Apple Fiber	500mg	100%
Apple Cider Vinegar	500mg	100%
Apple Pectin	500mg	100%
Apple Juice Concentrate	500mg	100%
Apple Fiber	500mg	100%
Apple Cider Vinegar	500mg	100%
Apple Pectin	500mg	100%
Apple Juice Concentrate	500mg	100%
Apple Fiber	500mg	100%
Apple Cider Vinegar	500mg	100%
Apple Pectin	500mg	100%
Apple Juice Concentrate	500mg	100%
Apple Fiber	500mg	100%
Apple Cider Vinegar	500mg	100%
Apple Pectin	500mg	100%
Apple Juice Concentrate	500mg	100%
Apple Fiber	500mg	100%
Apple Cider Vinegar	500mg	100%
Apple Pectin	500mg	100%
Apple Juice Concentrate	500mg	100%
Apple Fiber	500mg	100%
Apple Cider Vinegar	500mg	100%
Apple Pectin	500mg	100%
Apple Juice Concentrate	500mg	100%
Apple Fiber	500mg	100%
Apple Cider Vinegar	500mg	100%
Apple Pectin	500mg	100%
Apple Juice Concentrate	500mg	100%
Apple Fiber	500mg	100%
Apple Cider Vinegar	500mg	100%
Apple Pectin	500mg	100%
Apple Juice Concentrate	500mg	100%
Apple Fiber	500mg	100%
Apple Cider Vinegar	500mg	100%
Apple Pectin	500mg	100%
Apple Juice Concentrate	500mg	100%
Apple Fiber	500mg	100%
Apple Cider Vinegar	500mg	100%
Apple Pectin	500mg	100%
Apple Juice Concentrate	500mg	100%
Apple Fiber	500mg	100%
Apple Cider Vinegar	500mg	100%
Apple Pectin	500mg	100%
Apple Juice Concentrate	500mg	100%
Apple Fiber	500mg	100%
Apple Cider Vinegar	500mg	100%
Apple Pectin	500mg	100%
Apple Juice Concentrate	500mg	100%
Apple Fiber	500mg	100%
Apple Cider Vinegar	500mg	100%
Apple Pectin	500mg	100%
Apple Juice Concentrate	500mg	100%
Apple Fiber	500mg	100%
Apple Cider Vinegar	500mg	100%
Apple Pectin	500mg	100%
Apple Juice Concentrate	500mg	100%
Apple Fiber	500mg	100%
Apple Cider Vinegar	500mg	100%
Apple Pectin	500mg	100%
Apple Juice Concentrate	500mg	100%
Apple Fiber	500mg	100%
Apple Cider Vinegar	500mg	100%
Apple Pectin	500mg	100%
Apple Juice Concentrate	500mg	100%
Apple Fiber	500mg	100%
Apple Cider Vinegar	500mg	100%
Apple Pectin	500mg	100%
Apple Juice Concentrate	500mg	100%
Apple Fiber	500mg	100%
Apple Cider Vinegar	500mg	100%
Apple Pectin	500mg	100%
Apple Juice Concentrate	500mg	100%
Apple Fiber	500mg	100%
Apple Cider Vinegar	500mg	100%
Apple Pectin	500mg	100%
Apple Juice Concentrate	500mg	100%
Apple Fiber	500mg	100%
Apple Cider Vinegar	500mg	100%
Apple Pectin	500mg	100%
Apple Juice Concentrate	500mg	100%
Apple Fiber	500mg	100%
Apple Cider Vinegar	500mg	100%
Apple Pectin	500mg	100%
Apple Juice Concentrate	500mg	100%
Apple Fiber	500mg	100%
Apple Cider Vinegar	500mg	100%
Apple Pectin	500mg	100%
Apple Juice Concentrate	500mg	100%
Apple Fiber	500mg	100%

still being investigated. Furthermore, individual variations in vitamin D metabolism and absorption may influence the response to supplementation. Therefore, it is advisable for individuals with IBD to consult with their healthcare providers before initiating any vitamin D3 supplementation regimen.

**Ingredients:** see Supplement Facts.

**Manufacturer Country:** USA

**Product Amount:** 100 soft-gels

**Gross Weight:** 0.1lb (45g)

**Suggested Use:** As a dietary supplement, adults take one (1) soft-gel capsule daily or as directed by a health care professional. Store in a cool, dry place and away from direct light.

**DRSOUS.CA Vitamin D3 helps maintain bone density, strength and healthy cell growth**

Vitamin D3 is a fat-soluble vitamin that supports the growth and development of bones and teeth. It also plays an essential role in the functioning of the muscles and boosting energy levels in the body. The body naturally produces Vitamin D when exposed to sunlight, and you can also receive Vitamin D from some foods like oily fish. In the winter months, especially in colder regions, the body doesn't produce as much Vitamin D, which can lead to what's called 'seasonal depression.'

154

www.paradisewellness.ca A specific channel for Supplements on YouTube

Dr. Sous www.drsous.ca

### 3. L-Glutamine Powder

L-Glutamine powder has gained attention as a potential relief option for individuals suffering from irritable bowel syndrome (IBS). IBS is a common digestive disorder characterized by symptoms such as abdominal pain, bloating, and altered bowel movements. While the exact cause of IBS is still unknown, it is believed that inflammation and damage to the intestinal lining play a role in its development. L-Glutamine is an amino acid that is naturally produced in the body and is essential for various bodily functions, including gut health. It is known to support the integrity of the intestinal lining and aid in the repair of damaged tissues. As a result, L-Glutamine powder is thought to help alleviate the symptoms of IBS by promoting gut healing and reducing inflammation. Many individuals with IBS have reported positive effects after incorporating L-Glutamine powder into their daily routine. However, it is important to note that results may vary from person to person, and consulting with a healthcare professional is advised before starting any new supplement regimen.

**Ingredients:** see Supplement Facts.

**Flavor:** Unflavored

**Manufacturer Country:** USA

**Product Amount:** 0.66lb (300g)

**Gross Weight:** 0.7lb (205g)

**Suggested Use:** 1 serving 1 to 3 times daily with a beverage of choice or as directed by a health-care professional.

**DRSOUS.CA L-Glutamine Powder supports lean muscle mass and cell growth**

Regular price: \$46.00 CAD  
Product Amount: 0.66lb (300g)  
Gross Weight: 0.7lb (205g)  
L-Glutamine Powder supplementation is crucial for the body throughout exercise and sporting activities.  
L-Glutamine supports lean muscle mass, cell growth, and growth hormone release in the body, which is essential for improved performance.

- Enhances muscular strength
- Increases athletic performance
- Anti-fatigue

127

**Supplement Facts**

Serving Size 2 Grams (approximately 1/2 tsp)  
Servings Per Container: 150

Amount Per Serving	%Daily Value
L-Glutamine Powder	2 grams

\*Daily Value not established.

Vendor Code: LGU100-V02

A specific channel for L-Glutamine on YouTube

Paradise Wellness Dr. Sous www.drsous.ca

## CHAPTER VIII. DIGESTIVE SYSTEM PROBLEMS

Common digestive disorders include gastroesophageal reflux disease, cancer, irritable bowel syndrome, lactose intolerance and hiatal hernia. The most common symptoms of digestive disorders include bleeding, bloating, constipation, diarrhea, heartburn, pain, nausea and vomiting.

### 6 Common Digestive Disorders

- Gastroesophageal Reflux Disease (GERD) Heartburn happens, but if it occurs regularly, you may need to be evaluated for GERD
- Chronic Diarrhea
- Chronic Constipation
- Gastroenteritis
- Ulcers
- Hemorrhoids

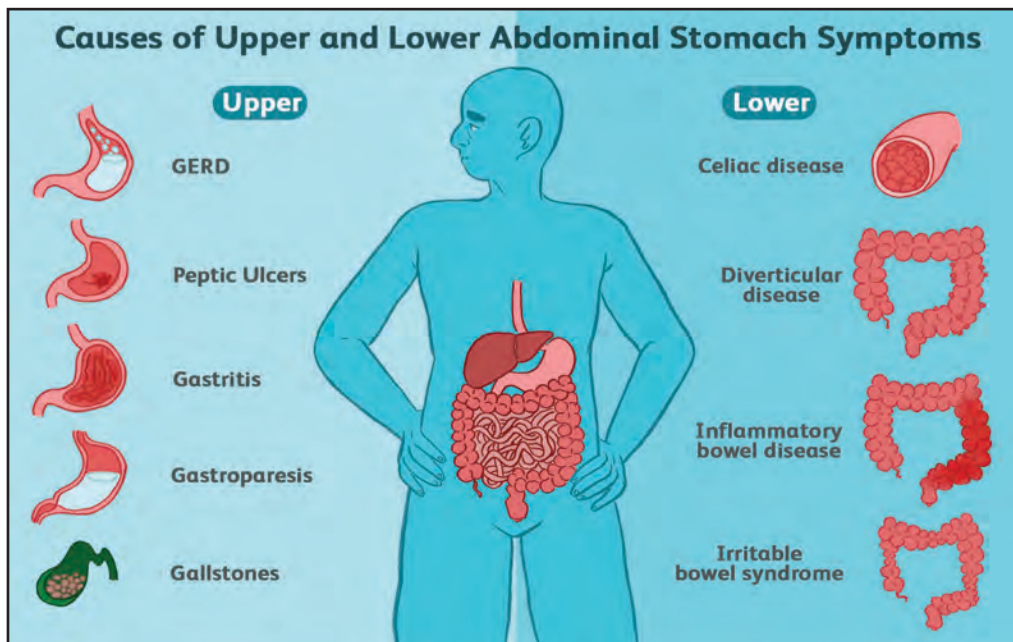

### 1. CROHN'S DISEASE

- Although Crohn's disease does not occur directly in the liver, it is important to take it into account since its symptoms such as inflammation of the digestive tract and malnutrition can affect the aforementioned organ.
- Crohn's disease is a type of inflammatory bowel condition which causes inflammation of the digestive tract. It can also cause abdominal pain, severe diarrhea, fatigue, weight loss and malnutrition.
- The inflammation can affect different areas of the digestive tract depending on the individual. Crohn's disease can be painful and debilitating and, in some cases, can lead to life-threatening complications.
- Although there is still no cure for this disease, there are therapies that help reduce symptoms. Even long-term remission and bowel inflammation can be achieved.

#### What are the causes of Crohn's disease?

The exact cause of Crohn's disease is unknown. It is a condition that occurs when the body's own immune system mistakenly attacks and destroys healthy body tissue (autoimmune disorder).

When parts of the digestive tract remain swollen or inflamed, the intestinal walls become thickened.

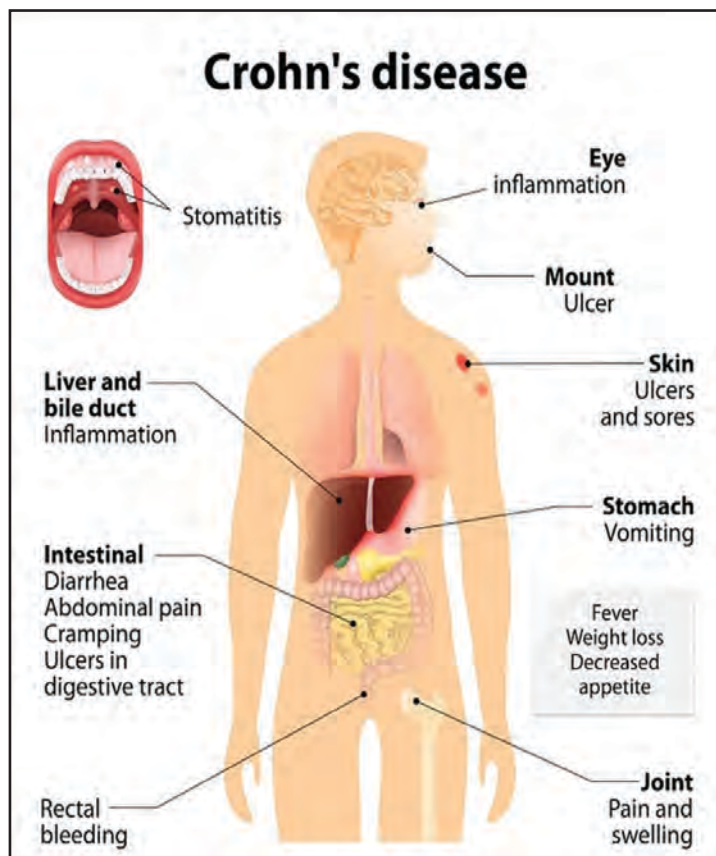

**Factors that may cause Crohn's disease are:**

- Genes and family history (people who are white or of European Jewish ancestry are at higher risk).
- Environmental factors.
- The body's tendency to overreact to normal bacteria in the intestines.
- Smoking.
- Occurs frequently in people between the ages of 15 and 35.

**# Symptoms**

This Crohn's disease commonly manifests with the following symptoms:

- Chronic diarrhea with abdominal pain
- Fever
- Anorexia
- Weight loss

The abdomen may hurt on contact, and a mass or busy area may be palpable. Gross rectorrhagia is unusual, except in isolated colonic disease, which may have manifestations similar to those of ulcerative colitis. Some patients debut with an acute abdomen simulating acute appendicitis or intestinal obstruction. About 33% of patients have perianal disease (especially fissures and fistulas), which is sometimes the most noticeable or even the initial manifestation. In children, extra-intestinal symptoms often predominate over digestive symptoms. Arthritis, fever of unknown etiology or growth retardation may be a presenting symptom. In case of recurrent disease, symptoms vary. Pain is very frequent and appears with both simple recurrence and abscess formation. Patients with severe exacerbation or abscess are likely to present with marked pain on palpation, defensiveness, pain on decompression and general toxic appearance. Stenotic segments may cause bowel obstruction, with colicky pain, bloating, constipation and vomiting.

**The recommended supplements for Crohn's disease are:** Probiotics, Digestive Enzyme, & Platinum Turmeric.

## 1. Probiotics

Probiotics have gained significant attention in recent years for their potential benefits in managing various health conditions, including Crohn's disease. Crohn's disease is a chronic inflammatory bowel disease characterized by inflammation of the gastrointestinal tract. It can cause symptoms such as abdominal pain, diarrhea, fatigue, and weight loss. While the exact cause of Crohn's disease is still unknown, research suggests that an imbalance in the gut microbiome may play a role in its development and progression. Probiotics, which are live microorganisms that confer health benefits when consumed in adequate amounts, have shown promise in alleviating symptoms and improving the overall well-being of individuals with Crohn's disease. They work by restoring the balance of beneficial bacteria in the gut, reducing inflammation, and enhancing the intestinal barrier function. Several strains of probiotics, including *Lactobacillus* and *Bifido-bacterium* species, have been studied for their potential therapeutic effects. Studies have shown that probiotics can reduce the frequency and severity of disease flares, improve quality of life, and decrease the need for medication in Crohn's disease patients.

**Ingredients:** See Supplement Facts.

**Manufacturer Country:** USA

**Product Amount:** 60 caps

**Gross Weight:** 0.25lb (113g)

**Suggested Use:** Take two (2) capsules once a day as a dietary supplement. For best results, take one (1) capsule during the day and one (1) capsule in the evening. Repeat the process daily. Do not exceed two capsules per day.

**Warning:** Keep out of reach of children. Do not use if the safety seal is damaged or missing. Store in a cool, dry place.

**DrSous.Ca Probiotic 40 Billion with Prebiotics**  
Regular price: \$27.00 CAD  
Product Amount: 60 caps  
Gross Weight: 0.25lb (113g)

Probiotic 40 Billion with Prebiotics is a blend of four probiotic strains: *Lactobacillus Acidophilus*, *Bifidobacterium Lactis*, *Lactobacillus Plantarum*, and *Lactobacillus Paracasei*. Together, they provide a high level of beneficial bacteria to the gut to support a healthy metabolic response for both men and women.

**Supplement Facts**  
Serving Size: 2 Capsules  
Servings Per Container: 30

	Amount Per Serving	%DV
Proprietary Blend of Probiotic Strains, MARCHER® Pat. Technology	40 Billion CFU	**
<i>Lactobacillus Acidophilus</i>	10 B.I.U.	
<i>Bifidobacterium Lactis</i>	10 B.I.U.	
<i>Lactobacillus Plantarum</i>	10 B.I.U.	
<i>Lactobacillus Paracasei</i>	10 B.I.U.	
Native Polysaccharide Complex	10 B.I.U.	
Fructooligosaccharide	10 B.I.U.	

\*\* Daily Value (DV) not established.

**Other Ingredients:** Cellulose (Vegetable Capsules), Non-medicinal, Canada.

Paradise Wellness | A specific channel for Probiotic 40 on YouTube

Dr. Sous | www.drsous.ca

## 2. Digestive Enzyme:

Digestive enzymes for Crohn's disease play a pivotal role in managing the symptoms and promoting better digestion for individuals diagnosed with this chronic inflammatory bowel disease. Crohn's disease affects the digestive tract, leading to inflammation, ulcers, and other complications that can disrupt the proper functioning of the gastrointestinal system. Digestive enzymes, such as amylase, protease, and lipase, aid in the breakdown and absorption of nutrients from food, which can be particularly beneficial for individuals with Crohn's disease who may have difficulty digesting certain foods. These enzymes help to break down carbohydrates, proteins, and fats, allowing for better nutrient absorption and reducing the strain on the digestive system. By improving digestion, digestive enzymes can alleviate symptoms such as bloating, gas, abdominal pain, and diarrhea, which are commonly experienced by Crohn's disease patients. Additionally, digestive enzymes can help prevent nutrient deficiencies that may occur due to malabsorption issues associated with Crohn's disease.

**Ingredients:** see Supplement Facts.

**Manufacturer Country:** USA

**Product Amount:** 60 caps





## 2. HIGH HELICOBACTER BACTERIA

H. pylori is a bacteria that can cause peptic ulcer disease and gastritis. It mostly occurs in children. Only 20% of those infected have symptoms. Symptoms include dull or burning stomach pain, unplanned weight loss and bloody vomit. H-pylori-caused ulcers are commonly treated with combinations of antibiotics and proton pump inhibitors.

H. pylori bacteria are present in some 50% to 75% of the world's population. It does not cause illness in most people. H. pylori infection mostly occurs in children. It's more common in developing countries. In the U.S., H. pylori bacteria are found in about 5% of children under the age of 10. Infection is most likely to occur in children who live in crowded conditions and areas with poor sanitation.

### # Symptoms

Most children with H. pylori infection don't have symptoms. Only about 20% do.

Symptoms and signs, if present, are those that arise from gastritis or peptic ulcer and include:

- Dull or burning pain in your stomach (more often a few hours after eating and at night). Your pain may last minutes to hours and may come and go over several days to weeks.
- Unplanned weight loss
- Bloating
- Nausea and vomiting (bloody vomit)
- Indigestion (dyspepsia)
- Burping
- Loss of appetite
- Dark stools (from blood in your stool)

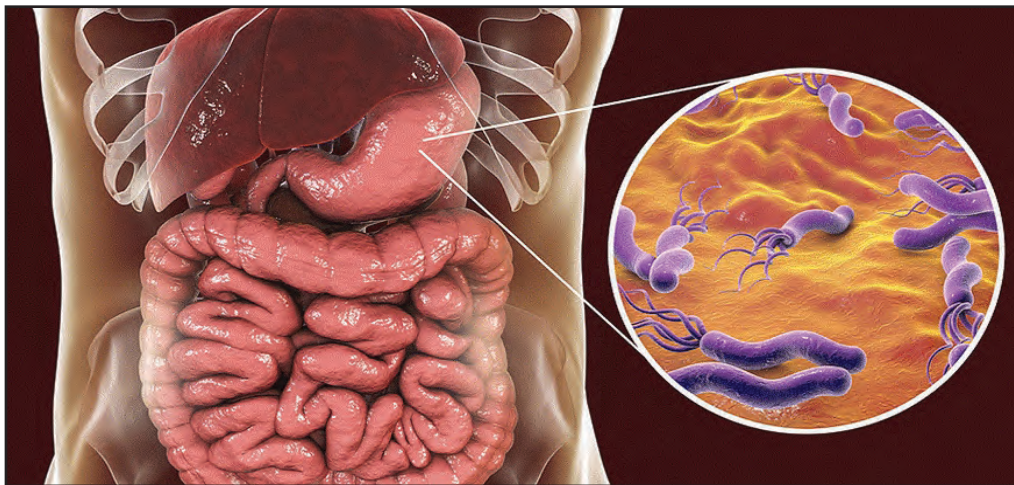

### Causes

H. pylori infection occurs when H. pylori bacteria infect your stomach. H. pylori bacteria are usually passed from person to person through direct contact with saliva, vomit or stool. H. pylori may also be spread through contaminated food or water. The exact way H. pylori bacteria causes gastritis or a peptic ulcer in some people is still unknown.

### Risk factors

People often get H. pylori infection during childhood. Risk factors for H. pylori infection are related to living conditions in childhood, such as:

- **Living in crowded conditions.** Living in a home with many other people can increase your risk of H. pylori infection.
- **Living without a reliable supply of clean water.** Having a reliable supply of clean, running water helps reduce the risk of H. pylori.
- **Living in a developing country.** People living in developing countries have a higher risk of H. pylori infection. This may be because crowded and unsanitary living conditions may be more common in developing countries.
- **Living with someone who has an H. pylori infection.** You're more likely to have H. pylori infection if you live with someone who

has H. pylori infection.

### Complications

Complications associated with H. pylori infection include:

- **Ulcers.** H. pylori can damage the protective lining of the stomach and small intestine. This can allow stomach acid to create an open sore (ulcer). About 10% of people with H. pylori will develop an ulcer.
- **Inflammation of the stomach lining.** H. pylori infection can affect the stomach, causing irritation and swelling (gastritis).
- **Stomach cancer.** H. pylori infection is a strong risk factor for certain types of stomach cancer.

### Treatment

H. pylori infections are usually treated with at least two different antibiotics at once. This helps prevent the bacteria from developing a resistance to one particular antibiotic.

**The most recommended supplements for H.pylori are:** Elderberry & Vitamin C, Bee Pearl pollen, & Birch Chaga Microbiome.

### 1. Elderberry & Vitamin C

Elderberry and Vitamin C have gained significant attention in recent years due to their potential benefits in combating H. pylori infections. H. pylori is a bacterial infection that affects the stomach lining and is one of the leading causes of peptic ulcers and chronic gastritis. Elderberry, derived from the Sambucus tree, is a rich source of antioxidants and has long been used for its immune-boosting properties. Studies have suggested that elderberry extract possesses antimicrobial activity against H. pylori, inhibiting its growth and reducing its ability to adhere to the stomach lining. Furthermore, elderberry has been found to have anti-inflammatory effects, which can help alleviate the symptoms associated with H. pylori infection. Vitamin C, on the other hand, is a powerful antioxidant that plays a crucial role in strengthening the immune system. It has been shown to possess antibacterial properties against H. pylori, inhibiting its growth and reducing the risk of infection. Additionally, vitamin C helps in the healing of the stomach lining and promotes the production of collagen, which is essential for maintaining the integrity of the gastrointestinal tract. While further research is needed to fully understand the effectiveness of elderberry and vitamin C in treating H. pylori infections, incorporating these natural remedies into a holistic treatment approach may offer potential benefits in reducing symptoms and promoting healing.



### 3) IRRITABLE BOWEL SYNDROME

Irritable bowel syndrome (IBS) is a common disorder that affects the stomach and intestines, also called the gastrointestinal tract. Symptoms include cramping, abdominal pain, bloating, gas, and diarrhea or constipation, or both. IBS is a chronic condition that you'll need to manage long term.

## What are the 4 stages of IBS?

There are four subcategories of IBS, each with equal prevalence:

- Mostly diarrhea and abdominal discomfort (IBS-D).
- Mostly constipation and abdominal discomfort (IBS-C).
- Alternating loose stools and constipation with abdominal discomfort (IBS-mixed).
- Undefined subtype (IBS-U) — symptoms vary.

## At what age does IBS usually begin?

- IBS can occur at any age. Often, it begins in the teen years or early adulthood. It is twice as common in women as in men. It is less likely to begin in older people above 50 years of age.

Only a small number of people with IBS have severe symptoms. Some people can control their symptoms by managing diet, lifestyle and stress. More-severe symptoms can be treated with medication and counseling. IBS doesn't cause changes in bowel tissue or increase your risk of colorectal cancer.

## # Symptoms

Symptoms of IBS vary but are usually present for a long time. The most common include:

- Abdominal pain, cramping or bloating that is related to passing a bowel movement
- Changes in appearance of bowel movement
- Changes in how often you are having a bowel movement

Other symptoms that are often related include sensation of incomplete evacuation and increased gas or mucus in the stool. See your health care provider if you have a persistent change in bowel habits or other symptoms of IBS. They may indicate a more serious condition, such as colon cancer.

## More-serious symptoms include:

- Weight loss
- Diarrhea at night
- Rectal bleeding
- Iron deficiency anemia
- Unexplained vomiting
- Pain that isn't relieved by passing gas or a bowel movement

## Causes

The exact cause of IBS isn't known. Factors that appear to play a role include:

**Muscle contractions in the intestine.** The walls of the intestines are lined with layers of muscle that contract as they move food through your digestive tract. Contractions that are stronger and last longer than usual can cause gas, bloating and diarrhea. Weak contractions can slow food passage and lead to hard, dry stools.

**Nervous system.** Issues with the nerves in your digestive system may cause discomfort when your abdomen stretches from gas or stool. Poorly coordinated signals between the brain and the intestines can cause your body to overreact to changes that typically occur in the digestive process. This can result in pain, diarrhea or constipation.

**Severe infection.** IBS can develop after a severe bout of diarrhea caused by bacteria or a virus. This is called gastroenteritis. IBS might also be associated with a surplus of bacteria in the intestines (bacterial overgrowth).

**Early life stress.** People exposed to stressful events, especially in childhood, tend to have more symptoms of IBS.

**Changes in gut microbes.** Examples include changes in bacteria, fungi and viruses, which typically reside in the intestines and play a key role in health. Research indicates that the microbes in people with IBS might differ from those in people who don't have IBS.

Triggers

**Symptoms of IBS can be triggered by:**

**Food.** The role of food allergy or intolerance in IBS isn't fully understood. A true food allergy rarely causes IBS. But many people have worse IBS symptoms when they eat or drink certain foods or beverages. These include wheat, dairy products, citrus fruits, beans, cabbage, milk and carbonated drinks.

**Stress.** Most people with IBS experience worse or more-frequent symptoms during periods of increased stress. But while stress may make symptoms worse, it doesn't cause them.

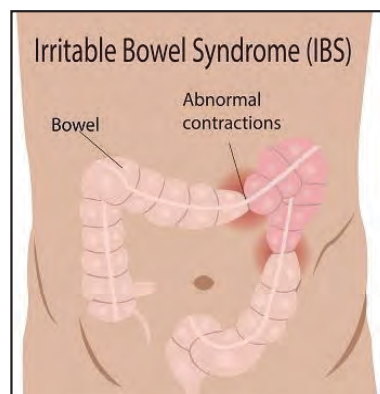

**The recommended supplement for IBS/ IBD are:** Platinum Turmeric, Vitamin D3, & L-Glutamine Powder.

### 1. Platinum Turmeric

Platinum Turmeric for IBD, also known as Inflammatory Bowel Disease, has gained significant attention in recent years as a potential natural remedy for managing the symptoms of this chronic condition. IBD, which includes Crohn's disease and ulcerative colitis, is characterized by inflammation in the digestive tract, leading to symptoms such as abdominal pain, diarrhea, fatigue, and weight loss. Traditional treatments for IBD often involve medications that suppress the immune system, but they can come with side effects and may not be effective for everyone. Platinum Turmeric, on the other hand, offers a promising alternative with its natural anti-inflammatory properties. Turmeric, a spice derived from the *Curcuma longa* plant, contains a compound called curcumin, which has been shown to have powerful anti-inflammatory and antioxidant effects. These properties make Platinum Turmeric an attractive option for IBD patients, as it may help reduce inflammation in the gut and alleviate the symptoms associated with the condition. Furthermore, Platinum Turmeric has been found to modulate the immune system, which is crucial in managing IBD. It can help regulate the production of cytokines, which are small proteins involved in inflammation. By balancing the immune response, Platinum Turmeric may contribute to a reduction in flare-ups and promote overall gut health. Additionally, Platinum Turmeric has been studied for its potential to support gut microbiota, the community of microorganisms in our digestive system. Dysbiosis, an imbalance in gut bacteria, is commonly observed in IBD patients and can worsen the symptoms. Platinum Turmeric has shown antimicrobial properties against harmful bacteria while promoting the growth of beneficial strains. This dual action may help restore the balance of gut microbiota and improve the overall health of the digestive system. Our Platinum Turmeric blend contains various forms of turmeric, glucosamine, Boswellia extract (frankincense), piperine, and several other highly beneficial natural extracts to improve its absorption and to keep you at your best. Natural extracts have been used for centuries in Ayurvedic medicine to remedy illnesses. We harness and advance these natural extracts in modern times for optimal bioavailability and effectiveness.

**Ingredients:** see Supplement Facts.

**Manufacturer Country:** USA



### 3. L-Glutamine Powder

L-Glutamine powder has gained attention as a potential relief option for individuals suffering from irritable bowel syndrome (IBS). IBS is a common digestive disorder characterized by symptoms such as abdominal pain, bloating, and altered bowel movements. While the exact cause of IBS is still unknown, it is believed that inflammation and damage to the intestinal lining play a role in its development. L-Glutamine is an amino acid that is naturally produced in the body and is essential for various bodily functions, including gut health. It is known to support the integrity of the intestinal lining and aid in the repair of damaged tissues. As a result, L-Glutamine powder is thought to help alleviate the symptoms of IBS by promoting gut healing and reducing inflammation. Many individuals with IBS have reported positive effects after incorporating L-Glutamine powder into their daily routine. However, it is important to note that results may vary from person to person, and consulting with a healthcare professional is advised before starting any new supplement regimen.

**Ingredients:** see Supplement Facts.

**Flavor:** Unflavored

**Manufacturer Country:** USA

**Product Amount:** 0.66lb (300g)

**Gross Weight:** 0.7lb (205g)

**Suggested Use:** 1 serving 1 to 3 times daily with a beverage of choice or as directed by a healthcare professional.

**DRSOUS.CA L-Glutamine Powder**  
supports lean muscle mass and cell growth

Regular price: \$46.00 CAD  
Product Amount: 0.66lb (300g)  
Gross Weight: 0.7lb (205g)

L-Glutamine Powder supplementation is crucial for the body throughout exercise and sporting activities.

L-Glutamine supports lean muscle mass, cell growth, and growth hormone release in the body, which is essential for improved performance.

- Enhances muscular strength
- Increases athletic performance
- Anti-fatigue

**Effective immune booster**

Supplement Facts	
Serving Size 2 Grams (approximately 1/2 tsp)	
Servings Per Container: 150	
Amount Per Serving	%Daily Value
L-Glutamine Powder	2 grams

\*Daily Value not established.

Vendor Code: LGU106-W02

Paradise Wellness | Dr. Sous | www.drsous.ca

### 4) BLADDER INFECTION

Bacteria can cause an infection of the bladder. A bladder infection is quite different from a urinary tract infection (UTI). UTI refers to infection of the entire urinary tract, including the bladder, ureters, urethra, kidneys and bladder. However, a bladder infection is simply an infection that affects the bladder only.

Infections are more predominant in women than in men. More than half the women on the globe will experience an infection at least once in their lives. There are two main types of bladder infections — simple and complicated. Most infections are the former type typically caused by the E. coli bacterium.

Simple infections occur in healthy individuals. On the other hand, complicated infections may be caused by other factors, including pregnancy, diabetes, catheters and urinary stents. Both simple and complicated infections can cause significant discomfort to victims. However, simple infections are much easier to treat than complicated ones.

#### Bladder Infection vs. UTI

A bladder infection is a form of urinary tract infection. However, urinary tract infections may not necessarily be bladder infections. The most common type of urinary tract infection is bladder infections or cystitis. A urinary tract infection affects one of multiple parts of the urinary tract, including the bladder, kidneys, urethra and ureters. The symptoms of UTI often vary depending on the affected area in the urinary tract.

## Complicated Bladder Infections

Most infections are simple and relatively easy to treat. Simple infections rarely cause complications. However, some infections can lead to major health complications (x). Such infections are usually called complicated bladder infections (x).

Complicated infections do not respond well to treatment. They are often caused by underlying health complications that make them worse (x). Several factors can make a bladder infection to become complicated (x):

- **Repeated infection:** Your healthcare provider may recommend a different treatment plan if you experience infections repeatedly. Some of the recommendations may include taking medications for longer than usual or IV of antibiotics every day for about a week. Patients who experience repeated infections should consider switching to different birth control methods.
- **Kidney damage:** Left untreated, an infection can spread to surrounding organs and tissues, including the kidneys, and cause significant long-term damage. Infections that spread to the kidneys may also cause scarring and high blood pressure.
- **Bladder infections and diabetes:** Diabetes usually worsens the symptoms of bladder infections.
- **Bladder infections and pregnancy:** Infections of the bladder are quite prevalent during pregnancy. Left untreated, they could cause health complications for both the mother and the baby.
- **Life-threatening health complications:** Bladder infections may spread to the kidneys and cause sepsis, which can be fatal.

## Signs of a Bladder Infection

The severity of a bladder infection determines its symptoms. Signs of a bladder infection are usually noticeable during urination. Some of the signs of a simple infection include:

- Pain or burning sensation during urination
- Bloody or cloudy urine
- Increased frequency of urination
- Odorous urine
- Cramping especially of the lower abdomen
- Sudden or urgent need to urinate

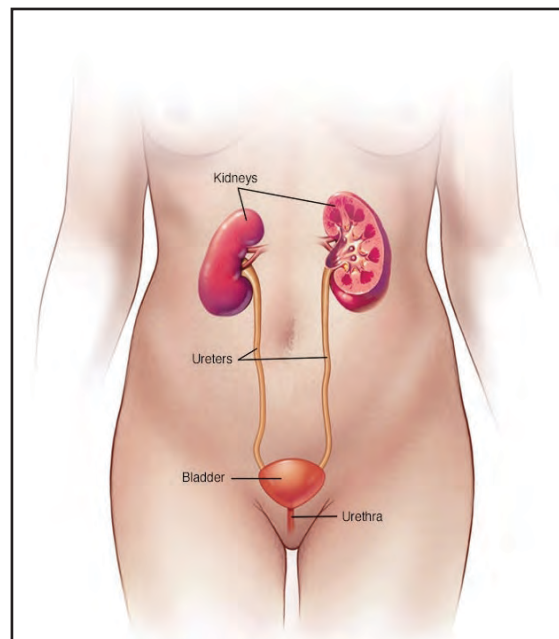

A complicated bladder infection may have the symptoms as a simple bladder infection as well as:

- Back pain that persist regardless of the sitting position or activity
- Chills
- Nausea and vomiting



- Confusion
- Fever

**The recommended supplement for bladder infection are:** Resveratrol, Probiotics, & Elderberry & Vitamin C.

### 1. Resveratrol:

Resveratrol, a natural compound found in various plants, has gained attention in recent years for its potential health benefits. One area of interest is its potential to combat bladder infections. Bladder infections, also known as urinary tract infections (UTIs), are a common medical issue that affects millions of people worldwide. Resveratrol has been studied for its antimicrobial properties, which may help in preventing and treating urinary tract infections. Research has shown that resveratrol can inhibit the growth of bacteria, including those responsible for causing bladder infections, such as *Escherichia coli* (*E. coli*). Moreover, resveratrol has been found to possess anti-inflammatory properties, which can help alleviate the symptoms associated with bladder infections, such as pain, frequent urination, and urgency. Additionally, resveratrol has been shown to enhance the immune system, which plays a crucial role in fighting off infections. By boosting immune function, resveratrol may aid in preventing recurrent bladder infections.

**Ingredients:** see Supplement Facts.

**Manufacturer Country:** USA

**Product Amount:** 60 caps

**Gross Weight:** 0.25lb (113g)

**Suggested Use:** Take one (1) veggie capsule twice a day as a dietary supplement. For best results, take 20-30 min before a meal or as directed by your healthcare professional.

**Caution:** Do not exceed recommended dose. Pregnant or nursing mothers, children under the age of 18, and individuals with a known medical condition should consult a physician before using this or any dietary supplement.

**Warning:** This product is not intended to diagnose, treat, cure or prevent any disease. Keep out of reach of children. Do not use if the safety seal is damaged or missing. Store in a cool, dry place.



### 2. Probiotics

Probiotics have gained significant attention in recent years for their potential health benefits, particularly in the realm of gut health. However, their role in managing bladder infections is a relatively new and promising area of research. These infections are typically caused by bacteria, such as *Escherichia coli* (*E. coli*), entering the urethra and traveling up to the bladder. Traditional treatment involves antibiotics, but the rise of antibiotic resistance and the desire for alternative options have led researchers to explore the potential of probiotics in preventing and treating bladder infections. Probiotics are live microorganisms that, when consumed in adequate amounts, confer health benefits to the host. They are commonly found in fermented foods, such as yogurt, kefir, and sauerkraut. These beneficial bacteria are thought to restore the natural balance of the gut microbiota, which plays a crucial role in maintaining overall health. The

rationale behind using probiotics for bladder infections lies in their ability to inhibit the growth and colonization of harmful bacteria in the urinary tract. Certain strains of probiotics, such as Lactobacillus and Bifidobacterium, have been shown to produce antimicrobial substances that can prevent the adhesion of pathogenic bacteria to the uro-epithelial cells of the bladder. By doing so, they may reduce the risk of infection and help alleviate symptoms associated with bladder infections. Moreover, probiotics have been found to strengthen the immune system, which plays a vital role in combating infections. They can modulate the immune response and enhance the production of antimicrobial peptides, which are natural substances that help fight off invading bacteria. By boosting the immune system's ability to defend against pathogens, probiotics may help reduce the frequency and severity of bladder infections.

**Ingredients:** See Supplement Facts.

**Manufacturer Country:** USA

**Product Amount:** 60 caps

**Gross Weight:** 0.25lb (113g)

**Suggested Use:** Take two (2) capsules once a day as a dietary supplement. For best results, take one (1) capsule during the day and one (1) capsule in the evening. Repeat the process daily. Do not exceed two capsules per day.

**Warning:** Keep out of reach of children. Do not use if the safety seal is damaged or missing. Store in a cool, dry place.



### 3. Elderberry & Vitamin C

Elderberry and Vitamin C are two natural remedies that have gained attention for their potential benefits in treating bladder infections. Elderberry, derived from the fruit of the elderberry plant, is known for its potent antioxidant and anti-inflammatory properties. It has been used for centuries in traditional medicine to boost the immune system and fight off infections. Elderberry contains flavonoids and anthocyanins, which have been shown to possess antimicrobial properties, making it a promising natural option for treating bladder infections. On the other hand, Vitamin C, also known as ascorbic acid, is an essential nutrient that plays a crucial role in maintaining a healthy immune system. It is known for its ability to boost immune function, fight off pathogens, and reduce inflammation. Vitamin C works by acidifying the urine, creating an environment that is unfavorable for the growth of bacteria in the urinary tract. Additionally, it enhances the production of white blood cells, which are responsible for fighting off infections in the body. When combined, elderberry and Vitamin C may provide a powerful combination to help alleviate the symptoms of bladder infections and support the body's natural defense against bacteria.

**Ingredients:** see Supplement Facts.

**Flavor:** Elderberry

**Manufacturer Country:** USA

**Product Amount:** 60 gummies

**Gross Weight:** 0.56lb (255g)

**Suggested Use:** Take two (2) gummies once a day as a dietary supplement.

**Caution:** Do not exceed recommended dose. Pregnant or nursing women, children under 18, and individuals with known medical conditions should consult their physician before taking.

**Warning:** Keep out of reach of children. Do not use if the safety seal is damaged or missing. Store in a cool, dry place.



## 5) URINARY TRACT INFECTION

Urinary tract infections are a common nuisance. UTIs occur mostly in women, but can frequently occur with men as well. Sexually active women between the ages of 25 and 35 years of age are the most common victims of UTIs. Studies indicate that as many as 35 percent of women under the age of 40 have experienced this form of infection. Due to the increasing number of sexually active women at younger ages, these infections may be increasing. In fact, a more recent study indicates that perhaps as many as half of all women will experience a urinary tract infection at some point. Escherichia coli or E. coli is the primary cause for the bulk of cases. In fact E. coli is responsible for up to 95 percent of reported occurrences. The rest of the cases are predominantly a result of Staphylococcus saprophyticus. There are two clinically differentiated types of urinary tract infection an upper UTI is referred to as pyelonephritis, while a lower UTI is referred to as cystitis. The hallmark symptoms of a urinary tract infection are dysuria, frequent and urgent urination and pelvic pain. More severe cases can cause fever and blood in the urine. Though there is no sure method to diagnose a urinary tract infection, urinalysis is the traditional way of indicating its probability. If leukocyte esterase or nitrites are present in a midstream urination, it is likely the culprit of the symptoms. Uropathogens that cause urinary tract infections can enter the urinary tract in various ways. Personal contact with others (especially through sexual contact) as well as food consumption can promote the spread of these pathogens.

### # Symptoms

#### Excessive, Urgent Need to Urinate

The most noticeable symptom of a urinary tract infection is the need to urinate frequently. Sometimes within minutes of going you might need to go again. In addition to frequency, an urgency to go is almost always present. You might feel no need to go one minute, and suddenly feel the need to urinate. Often there is little or no time to make it to the bathroom.

#### Pain or Irritation While Urinating

In addition to an increased frequency, pain or irritation while urinating is a common symptom. Often described as a burning sensation, this symptom, also called dysuria, is present in around 30 percent of cases. Because this symptom can occur in other maladies, it is important to diagnose this symptom properly and in the context of other symptoms.

#### Cloudy or Bloody Urine

Though slightly more uncommon, you might experience the symptom of cloudy urine or urine that contains blood. Protein or crystalline residue in the urinary tract can cause this. What's more, the cloudy appearance can be a result of residue in the urethra. This can be a serious symptom of other maladies. Your physician will determine if this is a symptom of a urinary tract infection or another ailment.

### Rectal, Pelvic or Abdominal Pain

Pain or tenderness might be present in the pelvic, rectal or abdominal areas. This can range from a mild discomfort to a dull ache. In general, a soreness might occur in any neighboring region and is a common complaint when UTIs present in clinical settings.

### Fever and Chills

A consistent fever can be present in a urinary tract infection. Particularly common in an upper UTI, this symptom usually presents itself with pyelonephritis cases.

### Nausea and Vomiting

Also occurring commonly in upper UTIs is the feeling of nausea. Vomiting can occur as a result, which you should inform your physician about immediately.

### Causes of Urinary Tract Infection

Though many cases of urinary tract infections present themselves in clinical settings with no known cause, there are some common factors that are frequently involved. The following are commonly associated behaviors or conditions that might be responsible for the UTI. Any or all of these might be present in your situation, so your physician will want to take a recent medical history to determine the cause.

### Kidney Stones

Urinary tract infections, especially those that are recurring, can be a sign of kidney stones. This is a serious medical condition. Your physician should determine whether your UTI is a result of stones so that the underlying condition can be treated.

### Sexual Intercourse

Intercourse can be the cause of a urinary tract infection. If your symptoms presented themselves shortly after engaging in sexual intercourse, this might very well be the case. Uropathogens can actually be transmitted from one partner to another during intercourse. A general sense of good personal hygiene in addition to good communication with your partner if symptoms occur can go a long way.

### Urinary Tract Infection While Pregnant

Pregnancy is also commonly associated with urinary tract infections. Immunosuppression of any kind, including pregnancy, can bring on the symptoms of a UTI. The normal defenses in such a state are not on guard. The result can be an onslaught of uropathogens that are able to take hold.

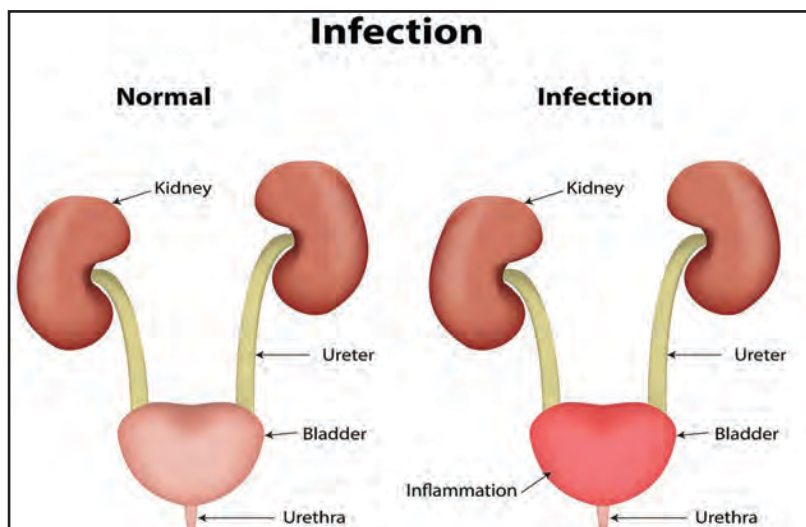

The most recommended supplements for UTI are: Elderberry & Vitamin C, Probiotic 40, & Platinum Turmeric.

## 1. Elderberry & Vitamin C

Elderberry and Vitamin C have gained popularity in recent years for their potential health benefits, including their potential role in managing urinary tract infections (UTIs). UTIs are a common condition that affects millions of people worldwide, particularly women. Elderberry, derived from the fruit of the *Sambucus nigra* plant, has been used for centuries in traditional medicine to treat various ailments. It is rich in antioxidants and vitamins, including Vitamin C. Vitamin C, or ascorbic acid, is a well-known immune-boosting nutrient that plays a crucial role in maintaining a healthy immune system. Both elderberry and Vitamin C have been studied for their potential antimicrobial properties, which could be beneficial in managing UTIs. Elderberry is believed to have anti-inflammatory effects and may help reduce the severity of UTI symptoms such as pain and inflammation. Additionally, elderberry and Vitamin C can help strengthen the immune system, enabling the body to fight off the infection more effectively. Vitamin C also increases the acidity of urine, which is unfavorable for the growth of bacteria that cause UTIs. While elderberry and Vitamin C may offer some potential benefits in managing UTIs, it is important to note that they should not be considered as a standalone treatment. It is crucial to consult with a healthcare professional for an accurate diagnosis and appropriate treatment plan.

**Ingredients:** see Supplement Facts.

**Flavor:** Elderberry

**Manufacturer Country:** USA

**Product Amount:** 60 gummies

**Gross Weight:** 0.56lb (255g)

**Suggested Use:** Take two (2) gummies once a day as a dietary supplement.

**Caution:** Do not exceed recommended dose. Pregnant or nursing women, children under 18, and individuals with known medical conditions should consult their physician before taking.

**Warning:** Keep out of reach of children. Do not use if the safety seal is damaged or missing. Store in a cool, dry place.



## 2. Probiotic 40

Probiotics have gained significant attention in recent years for their potential role in promoting gut health and overall well-being. However, their benefits extend beyond the digestive system, as emerging research suggests that probiotics may also play a crucial role in preventing and managing urinary tract infections (UTIs). UTIs, primarily caused by bacterial overgrowth in the urinary system, can be both uncomfortable and recurrent for many individuals. Antibiotics have traditionally been the go-to treatment for UTIs, but their overuse has led to concerns about antibiotic resistance and the disruption of the body's natural microbiome. Probiotics, on the other hand, offer a more natural and targeted approach in combating UTIs. By introducing beneficial bacteria into the urinary tract, probiotics can help restore the balance of microorganisms, thereby inhibiting the growth of harmful bacteria that can cause UTIs. Certain strains of probiotics, such as *Lactobacillus* and *Bifidobacterium*, have shown promising results in clinical studies by reducing the recurrence of UTIs and alleviating symptoms. These probiotics work by producing anti-microbial substances, enhancing the immune response, and competing with pathogenic bacteria for resources, effectively creating an unfavorable environment for UTI-causing bac-

teria to thrive. While more research is needed to fully understand the mechanisms and optimal dosage of probiotics for UTI prevention and treatment, their potential as a natural and safe alternative to antibiotics is encouraging. Incorporating probiotic-rich foods like yogurt, kefir, and sauerkraut into one's diet, or taking probiotic supplements under the guidance of a healthcare professional, may be a beneficial strategy to support urinary tract health and reduce the risk of UTIs.

**Ingredients:** See Supplement Facts.

**Manufacturer Country:** USA

**Product Amount:** 60 caps

**Gross Weight:** 0.25lb (113g)

**Suggested Use:** Take two (2) capsules once a day as a dietary supplement. For best results, take one (1) capsule during the day and one (1) capsule in the evening. Repeat the process daily. Do not exceed two capsules per day.

**Warning:** Keep out of reach of children. Do not use if the safety seal is damaged or missing. Store in a cool, dry place.



### 3. Platinum Turmeric

Platinum Turmeric for UTI is a trending topic in the realm of natural remedies for urinary tract infections (UTIs). UTIs are a common infection that affects millions of people worldwide, causing discomfort, pain, and inconvenience. Traditional treatment options often involve antibiotics, but the emergence of antibiotic resistance has led individuals to seek alternative solutions. Platinum Turmeric, a potent and natural supplement, has gained attention for its potential to alleviate UTI symptoms and promote overall urinary health. Turmeric, derived from the Curcuma longa plant, is renowned for its anti-inflammatory and antioxidant properties. These properties are believed to help combat the bacteria responsible for UTIs and reduce inflammation in the urinary tract. Additionally, turmeric is known to boost the immune system, which can aid in fighting off infections. Platinum Turmeric is a high-quality supplement that harnesses the power of turmeric in a concentrated form, ensuring maximum effectiveness. It is often available in the form of capsules or powder, making it easy to incorporate into one's daily routine. Furthermore, Platinum Turmeric is produced using rigorous quality control measures, ensuring that it is free from contaminants and maintains its potency.

**Ingredients:** see Supplement Facts.

**Manufacturer Country:** USA

**Product Amount:** 60 caps

**Gross Weight:** 0.25lb (113g)

**Suggested Use:** Take two (2) capsules once a day as a dietary supplement. For best results, take 20-30 min before a meal or as directed by your healthcare professional.

**Caution:** Consult a physician before use if you have any medical conditions. Glucosamine is derived from shellfish. People allergic to shellfish should not consume this product.

**Warning:** Keep out of reach of children. Do not use if the safety seal is damaged or missing. Store in a cool, dry place.



## 6) HEMORRHOIDS

Hemorrhoids are swollen veins in your lower rectum. Internal hemorrhoids are usually painless, but tend to bleed. External hemorrhoids may cause pain. Hemorrhoids, also called piles, are swollen veins in your anus and lower rectum, similar to varicose veins.

### #Symptoms

Signs and symptoms of hemorrhoids usually depend on the type of hemorrhoid.

#### External hemorrhoids

These are under the skin around your anus. Signs and symptoms might include:

- Itching or irritation in your anal region
- Pain or discomfort
- Swelling around your anus
- Bleeding

#### Internal hemorrhoids

Internal hemorrhoids lie inside the rectum. You usually can't see or feel them, and they rarely cause discomfort. But straining or irritation when passing stool can cause:

- Painless bleeding during bowel movements. You might notice small amounts of bright red blood on your toilet tissue or in the toilet.
- A hemorrhoid to push through the anal opening (prolapsed or protruding hemorrhoid), resulting in pain and irritation.

#### Thrombosed hemorrhoids

If blood pools in an external hemorrhoid and forms a clot (thrombus), it can result in:

- Severe pain
- Swelling
- Inflammation
- A hard lump near your anus

#### Causes

The veins around your anus tend to stretch under pressure and may bulge or swell. Hemorrhoids can develop from increased pressure in the lower rectum due to:

- Straining during bowel movements
- Sitting for long periods of time on the toilet

- Having chronic diarrhea or constipation
- Being obese
- Being pregnant
- Having anal intercourse
- Eating a low-fiber diet
- Regular heavy lifting

### Will hemorrhoids go away on their own?

In general, small hemorrhoids can go away on their own in a few days. Larger hemorrhoids, particularly ones that cause a lot of pain, swelling, and itchiness, can't go away on their own and may require treatment from a doctor to heal. Pregnant patients may find that hemorrhoids only go away after they give birth.

### How do you know if you have?

Feel discomfort, itching, or pain around your anus. See blood on the toilet paper or in the toilet bowl when you go to the bathroom. Get moist, pink bumps around the edge of or bulging out from your anus (These may look purple or blue, too.)

### Prevention

The best way to prevent hemorrhoids is to keep your stools soft, so they pass easily. To prevent hemorrhoids and reduce symptoms of hemorrhoids, follow these tips:

Be mindful about keeping unnecessary pressure off your abdomen. Even small changes in your lifestyle can make a big difference in limiting the recurrence of hemorrhoids. Ensure you are taking breaks to incorporate physical activity in your daily routine, stay hydrated and eat well.

- **Modify your workspace** to reduce unnecessary pressure on your bottom. Consider placing a pillow on your chair, creating a standing desk or using a foot stool to relieve pressure.
- **Get plenty of exercise.** Exercise aids digestion and helps in achieving regular bowel movements. Walking and yoga are helpful ways to keep your bowel movements consistent.
- **Increase your fibre intake.** Fruits, vegetables, whole grain breads and fibre-rich cereals are good sources of fibre. By including more fibre in your diet, stools will be softer, diminishing the discomfort of bowel movements. This may also help you avoid constipation.
- **Drink plenty of fluids,** especially water and fruit juices. Try to avoid coffee and alcohol, which can dehydrate you and lead to constipation.

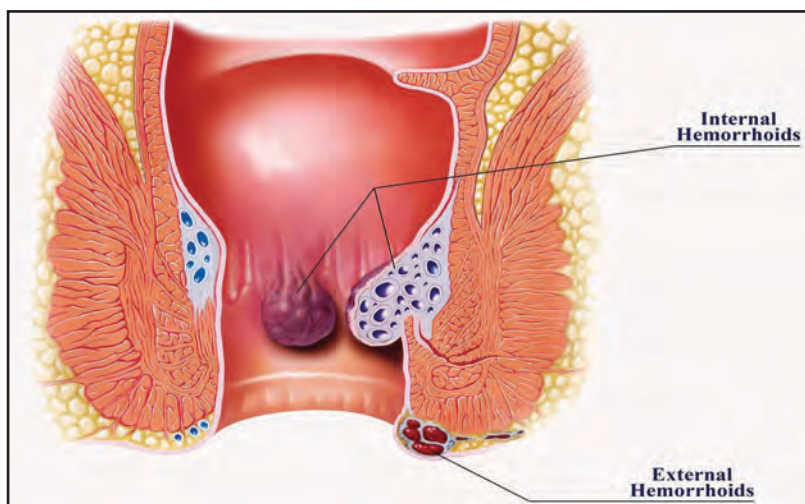

The most recommended supplements for hemorrhoids are: Psyllium Husks, Probiotics & Platinum Turmeric.



## 1. Psyllium Husks

Hemorrhoids, also known as piles, are swollen veins in the rectum and anus that can cause discomfort, pain, and itching. While there are several treatment options available, incorporating psyllium husks into one's diet may provide relief and help prevent further aggravation of hemorrhoids. Psyllium husks are a rich source of dietary fiber, known for their ability to promote healthy bowel movements and alleviate constipation, which is a common contributing factor to hemorrhoid development. By adding bulk to the stool, psyllium husks can help soften it, making it easier to pass, thereby reducing the strain on the hemorrhoidal veins. Additionally, the soluble fiber in psyllium husks forms a gel-like substance when mixed with water, which can help regulate bowel movements and promote regularity. This can be particularly beneficial for individuals with hemorrhoids, as it reduces the likelihood of straining during bowel movements, further easing discomfort and minimizing the risk of exacerbating the condition. Furthermore, psyllium husks have been shown to have anti-inflammatory properties, which can help reduce swelling and irritation associated with hemorrhoids. By soothing the affected area, psyllium husks may provide much-needed relief and contribute to the healing process. It is important to note, however, that while psyllium husks can be beneficial for hemorrhoid management, they should be used as part of a comprehensive treatment plan that includes good hygiene practices, a healthy diet, and other recommended interventions.



## 2. Probiotics

Probiotics, which are live bacteria and yeasts that are beneficial to the body, have been found to have anti-inflammatory properties and can help restore the balance of the gut microbiota. This has led to the exploration of their potential in alleviating symptoms associated with hemorrhoids. Probiotic supplements containing strains such as *Lactobacillus acidophilus* and *Bifidobacterium bifidum* have been shown to reduce inflammation and improve overall gut health. By promoting a healthy gut environment, these supplements may help regulate bowel movements, soften stools, and reduce the risk of constipation, which can exacerbate hemorrhoid symptoms. Moreover, the use of probiotics can enhance the body's immune response, aiding in the healing process of hemorrhoids. However, it is important to note that while probiotic supplements may provide relief for some individuals, they should not be seen as a standalone treatment for hemorrhoids. Consulting with a healthcare professional is crucial to determine the most appropriate course of action, as each person's condition may vary. It is also worth mentioning that incorporating a balanced diet, regular exercise, and maintaining good hygiene practices are essential in managing hemorrhoids effectively.

**Ingredients:** See Supplement Facts.

**Manufacturer Country:** USA

**Product Amount:** 60 caps

**Gross Weight:** 0.25lb (113g)

**Suggested Use:** Take two (2) capsules once a day as a dietary supplement. For best results, take one (1) capsule during the day and one (1) capsule in the evening. Repeat the process daily. Do not exceed two capsules per day.

**Warning:** Keep out of reach of children. Do not use if the safety seal is damaged or missing. Store in a cool, dry place.



### 3. Platinum Turmeric

Platinum Turmeric supplement offers a natural and effective solution to alleviate the symptoms and promote healing. Turmeric, a bright yellow spice derived from the *Curcuma longa* plant, has been used for centuries in traditional medicine for its anti-inflammatory and antioxidant properties. It contains an active compound called curcumin, which has been scientifically proven to reduce inflammation and pain. When combined with other natural ingredients, Platinum Turmeric supplement provides a powerful blend that targets the root causes of hemorrhoids. This supplement not only helps to reduce inflammation and pain but also supports healthy blood circulation, which is crucial for the healing process.

**Ingredients:** see Supplement Facts.

**Manufacturer Country:** USA

**Product Amount:** 60 caps

**Gross Weight:** 0.25lb (113g)

**Suggested Use:** Take two (2) capsules once a day as a dietary supplement. For best results, take 20-30 min before a meal or as directed by your healthcare professional.

**Caution:** Consult a physician before use if you have any medical conditions. Glucosamine is derived from shellfish. People allergic to shellfish should not consume this product.

**Warning:** Keep out of reach of children. Do not use if the safety seal is damaged or missing. Store in a cool, dry place.



### 7) COLD BLADDER

Also known as interstitial cystitis is a chronic condition causing bladder pressure, bladder pain and sometimes pelvic pain. The pain ranges from mild discomfort to severe pain. The condition is a part of a spectrum of diseases known as painful bladder syndrome. Your bladder is a hollow, muscular organ that stores urine. The bladder expands until it's full and then signals your brain that it's time to urinate, communicating through the pelvic nerves. This creates the urge to urinate for most people.

#### Interstitial cystitis

Your bladder, kidneys, ureters and urethra make up your urinary system. When you have interstitial cystitis, the walls of your bladder become irritated and inflamed compared with those of a normal bladder.

With interstitial cystitis, these signals get mixed up you feel the need to urinate more often and with smaller volumes of urine than most people.

Interstitial cystitis most often affects women and can have a long-lasting impact on quality of life.

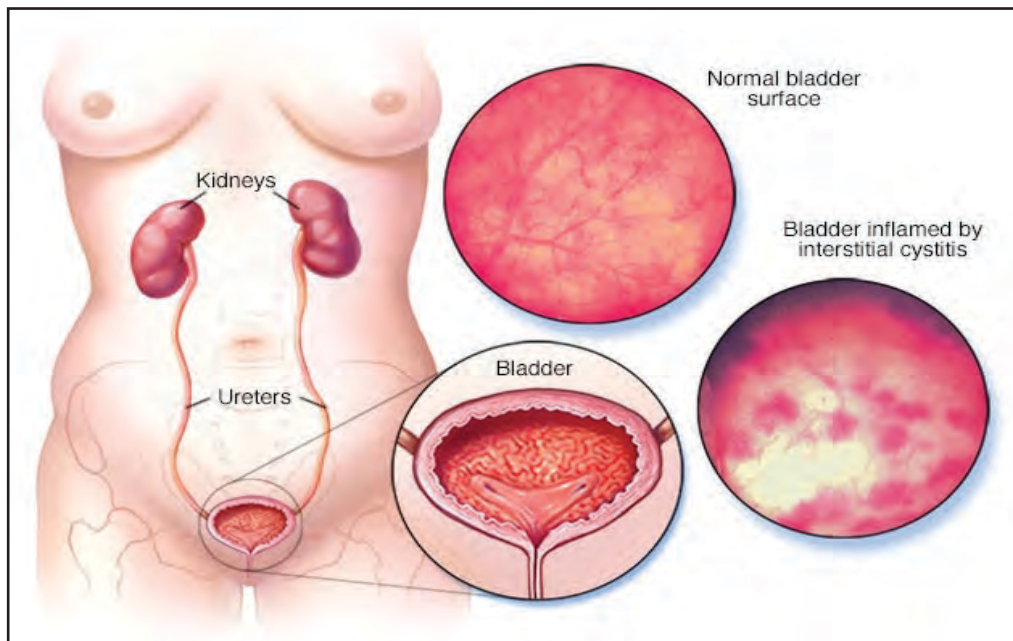

### #Symptoms

The signs and symptoms of interstitial cystitis vary from person to person. If you have interstitial cystitis, your symptoms may also vary over time, periodically flaring in response to common triggers, such as menstruation, sitting for a long time, stress, exercise and sexual activity.

### Interstitial cystitis signs and symptoms include:

- Pain in your pelvis or between the vagina and anus in women
- Pain between the scrotum and anus (perineum) in men
- Chronic pelvic pain
- A persistent, urgent need to urinate
- Frequent urination, often of small amounts, throughout the day and night (up to 60 times a day)
- Pain or discomfort while the bladder fills and relief after urinating
- Pain during sex

### Risk factors

These factors are associated with a higher risk of interstitial cystitis:

- **Your sex.** Women are diagnosed with interstitial cystitis more often than men. Symptoms in men may mimic interstitial cystitis, but they're more often associated with an inflammation of the prostate gland (prostatitis).
- **Your age.** Most people with interstitial cystitis are diagnosed during their 30s or older.
- **Having a chronic pain disorder.** Interstitial cystitis may be associated with other chronic pain disorder, such as irritable bowel syndrome or fibromyalgia.

**The most recommended supplements for interstitial cystitis are:** Resveratrol, Platinum Turmeric, & Probiotics.

#### 1. Resveratrol

Research suggests that resveratrol may offer some therapeutic benefits for individuals suffering from cold bladder. Resveratrol possesses anti-inflammatory properties, which may help alleviate the inflammation and pain associated with this condition. Moreover, it has been found to exhibit antioxidant effects, which can help protect bladder cells from oxidative stress and damage. Additionally, resveratrol has been shown to modulate the immune system, potentially reducing immune-mediated inflammation in the bladder.

**Ingredients:** see Supplement Facts.

**Manufacturer Country:** USA

**Product Amount:** 60 caps

**Gross Weight:** 0.25lb (113g)

**Suggested Use:** Take one (1) veggie capsule twice a day as a dietary supplement. For best results, take 20-30 min before a meal or as directed by your healthcare professional.

**Caution:** Do not exceed recommended dose. Pregnant or nursing mothers, children under the age of 18, and individuals with a known medical condition should consult a physician before using this or any dietary supplement.

**Warning:** This product is not intended to diagnose, treat, cure or prevent any disease. Keep out of reach of children. Do not use if the safety seal is damaged or missing. Store in a cool, dry place.



## 2. Platinum Turmeric

Interstitial cystitis is a chronic condition characterized by bladder pain, frequent urination, and a strong urge to urinate. It can significantly impact a person's quality of life, causing discomfort and limitations in daily activities. One potential solution that has gained attention in recent years is the use of platinum turmeric supplements. Turmeric, a spice commonly used in curries and traditional medicine, contains a compound called curcumin, which possesses potent anti-inflammatory and antioxidant properties. These properties make it a promising option for managing the symptoms of interstitial cystitis. Platinum turmeric supplements, specifically formulated with a high concentration of curcumin, offer an effective and convenient way to incorporate this natural remedy into one's daily routine. By reducing inflammation and oxidative stress in the bladder, curcumin may help alleviate the pain and urgency associated with interstitial cystitis. Additionally, curcumin has been shown to modulate the immune system and promote a healthy gut microbiome, which could have further benefits for individuals with interstitial cystitis.

**Ingredients:** see Supplement Facts.

**Manufacturer Country:** USA

**Product Amount:** 60 caps

**Gross Weight:** 0.25lb (113g)

**Suggested Use:** Take two (2) capsules once a day as a dietary supplement. For best results, take 20-30 min before a meal or as directed by your healthcare professional.

**Caution:** Consult a physician before use if you have any medical conditions. Glucosamine is derived from shellfish. People allergic to shellfish should not consume this product.

**Warning:** Keep out of reach of children. Do not use if the safety seal is damaged or missing. Store in a cool, dry place.



### 3. Probiotics

Probiotics are live microorganisms that, when consumed in adequate amounts, can confer health benefits. Research suggests that probiotics may help modulate the gut microbiota and reduce inflammation, which could potentially alleviate symptoms associated with interstitial cystitis. Certain strains of probiotics, such as Lactobacillus and Bifidobacterium, have been investigated for their potential in managing interstitial cystitis. These strains are known to promote a healthy balance of bacteria in the gut and may have anti-inflammatory effects. By restoring the gut microbiota's equilibrium, probiotics may help reduce systemic inflammation, which could indirectly benefit the bladder.

**Ingredients:** See Supplement Facts.

**Manufacturer Country:** USA

**Product Amount:** 60 caps

**Gross Weight:** 0.25lb (113g)

**Suggested Use:** Take two (2) capsules once a day as a dietary supplement. For best results, take one (1) capsule during the day and one (1) capsule in the evening. Repeat the process daily. Do not exceed two capsules per day.

**Warning:** Keep out of reach of children. Do not use if the safety seal is damaged or missing. Store in a cool, dry place.



### 8) CONSTIPATION

Constipation is a condition in which you may have fewer than three bowel movements a week; stools that are hard, dry, or lumpy; stools that are difficult or painful to pass; or a feeling that not all stool has passed. It happens most often due to changes in diet or routine, or due to inadequate intake of fiber.

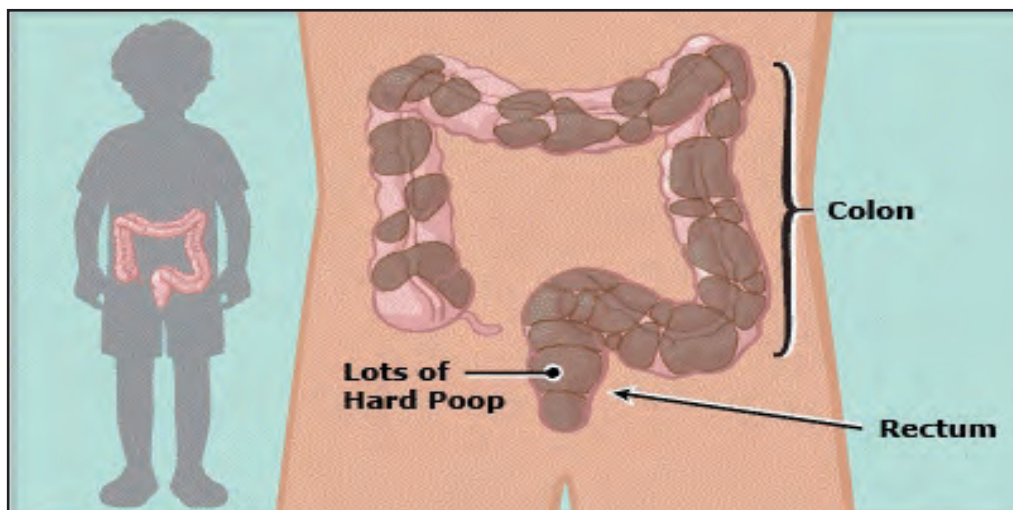

## Causes

Causes of constipation can be as diverse as the people experiencing it. While eating foods low in fibre or not drinking enough water are some of the most common reasons, constipation can also be triggered by factors like stress, changes in your regular routine due to traveling, or eating new & different cuisines, and even going to sleep at odd times.

- Changes in your life or routine (including travel)
- Stress
- Ignoring the urge to go
- Lack of fibre in your diet
- Dehydration
- Not enough exercise
- Being pregnant or having recently given birth (one of the reasons why, statistically, women suffer more from constipation than men)
- Some medications
- Certain medical conditions

## # Symptoms

### 1. Inability to Move Bowels

The most obvious symptom of constipation is the inability to pass stool. An individual may feel as if they need to or are about to have a bowel movement but cannot complete the action. When this occurs, it is important to avoid straining, as this can cause more problems, such as tearing and hemorrhoids.

### 2. Decrease in Regular Bowel Movements

Regular bowel movements can occur more or less often, depending on the person, but if one's personal schedule changes significantly, they could have constipation. Often, the cause of constipation can be determined by examining the diet or activities of the past few days. Often, dietary changes, sometimes as simple as increasing fiber and drinking more water can have a positive effect.

### 3. Passing Hard Stool

A constipated person may still be able to pass stool, though the process can be difficult and painful and the stool is often hard. Over-the-counter stool softeners can provide relief in most cases. If the problem persists, however, individuals should make a doctor's appointment to discuss treatment and potential causes. Blockages and other complications can occur as a result of hardened stool.

### 4. Gas

Gas often occurs as a symptom of constipation, especially when it stems from a pre-existing condition such as irritable bowel syndrome (IBS). Gas is typically accompanied by a feeling of pressure in the abdomen. A bowel movement may relieve gas. However, if gas persists, it could indicate a more serious problem.

**The most recommended supplements for constipation are:** Psyllium Husks, Magnesium Glycinate, & Birch Chaga Microbiome.

### 1. Psyllium Husks

Psyllium husks have gained popularity as a natural remedy for constipation, and for good reason. Derived from the seeds of the *Plantago ovata* plant, these tiny husks are packed with soluble fiber, making them an effective and gentle solution for bowel irregularities. When consumed, psyllium husks absorb water and form a gel-like substance in the intestines, which helps to soften the stool and ease its passage through the digestive tract. This increased bulk stimulates peristalsis, the rhythmic contractions of the intestines that move waste along, thereby relieving constipation. Additionally, the gel-like consistency of psyllium helps to regulate bowel movements, whether one is experiencing diarrhea or constipation. Psyllium husks have also been shown to promote overall digestive health by supporting the growth of beneficial gut bacteria, improving gut motility, and reducing the risk of other gastrointestinal disorders. Moreover, psyllium husks are a convenient and affordable option for those seeking natural relief from constipation. They can be easily

incorporated into one's daily routine by mixing them with water, juice, or yogurt, or by adding them to smoothies, baked goods, or cereals. However, it is important to note that psyllium husks should always be consumed with sufficient water or fluid intake, as failing to do so can lead to intestinal blockages.



## 2. Magnesium Glycinate

Magnesium Glycinate is a form of magnesium that has gained attention for its potential benefits in relieving constipation. Constipation is a common digestive issue that can cause discomfort and disrupt daily life. Magnesium is an essential mineral that plays a crucial role in various bodily functions, including muscle contractions, nerve function, and bowel movements. When it comes to constipation, magnesium acts as an osmotic laxative, which means it draws water into the intestines, softening the stool and promoting regular bowel movements. Magnesium Glycinate is a highly bioavailable form of magnesium, meaning it is easily absorbed by the body. This enhanced absorption can lead to more efficient and effective relief from constipation. Additionally, Magnesium Glycinate is generally well-tolerated and less likely to cause digestive side effects compared to other forms of magnesium.



## 3. Birch Chaga Microbiome

The Birch Chaga fungus, scientifically known as *Inonotus obliquus*, is a powerful adaptogen that grows on birch trees in cold climates. It has long been used in traditional medicine for its potential health benefits. One of the key reasons Birch Chaga has shown promise in alleviating constipation is due to its rich composition of bioactive compounds, including polysaccharides, antioxidants, and triterpenoids. These compounds have been found to possess anti-inflammatory, immunomodulatory, and antimicrobial properties, which may help regulate bowel movements and improve overall gut health. The microbiome, consisting of trillions of bacteria, fungi, and other microorganisms residing in our gastrointestinal tract, plays a crucial role in maintaining digestive function and promoting regularity. By positively impacting the gut microbiome, Birch Chaga supplements may help restore the balance of beneficial bacteria, leading to





timeframe. Dehydration is a very real side effect of severe diarrhea. Also, avoid spicy foods and other things that will only make an already uncomfortable situation worse.

## 2. Acute Symptoms of Diarrhea

You should contact a doctor if you have experienced watery, loose stools for more than two days. If several rectal or abdominal pains are associated with the condition, call your physician immediately. A fever over 102 F (39 C) is a severe symptom of diarrhea as well as bloody or black stools. If you become dehydrated as a result of diarrhea, you will need to seek medical attention right away. When children, especially toddlers and babies, experience diarrhea, they can reach a level of dehydration rather quickly. You need to call a doctor if your child has symptoms for more than a day. Symptoms of dehydration for children are akin to those of adults; however, nausea and the inability to keep food in the stomach are also a factor in childhood dehydration. Symptoms related to diarrhea can sometimes be early indications of a more serious illness like irritable bowel disease, pancreatitis, or colon cancer.

## 3. Symptoms of Dehydration

If you lose too many fluids too quickly, you will become dehydrated. Because diarrhea is associated with watery, loose stools, the liquids are draining from your body too fast. Therefore, it is critical to rehydrate yourself by drinking plenty of fluids, especially extra water. Replacing the sodium and electrolytes in your body are also important. Broth, fruit juice, and other soups can help you rehydrate. Even certain kinds of sports drinks with electrolytes can help alleviate nausea associated with dehydration. Pay attention to signs of dehydration in connection to diarrhea including increased thirst, weakness, dizziness, sluggishness, confusion, dry mouth, inability to sweat, and decreased urine output. The color of your urine can also reveal symptoms of dehydration if it is deeply yellow or amber. Also, if you pinch all small piece of skin on your arm, and it stays white for several seconds before returning to its natural color, you may be dehydrated.

## 4. Symptoms of Persistent Diarrhea

Chronic diarrhea is categorized by the fact that a patient has the same symptoms for more than two weeks. The cause of the urgent bathroom breaks needs to be identified. You will have to explain to symptoms to a doctor as well as your medical history. Some common questions your physician will want to know include:

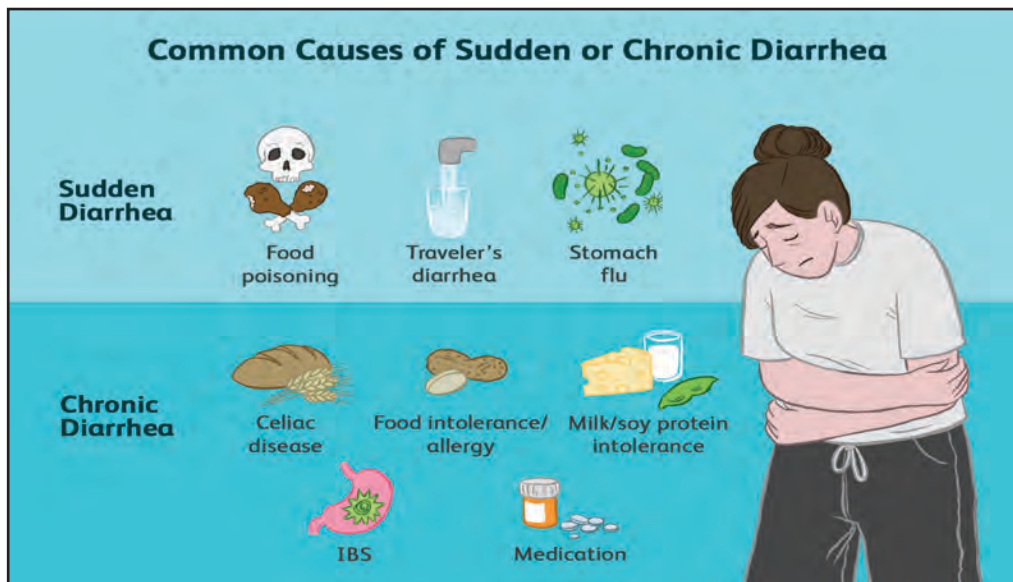

The most recommended supplements for diarrhea are: Psyllium husk, Probiotics, & Birch Chaga Truffles.

### 1. Psyllium husk

Psyllium husk derived from the seeds of the *Plantago ovata* plant, has gained recognition for its potential benefits in managing diarrhea.

Diarrhea is a condition characterized by loose and watery stools, often caused by various factors such as viral or bacterial infections, food intolerance, or side effects of medications. Psyllium husk, a soluble fiber, possesses unique properties that make it a promising natural remedy for alleviating diarrhea symptoms. When consumed, psyllium husk absorbs water and forms a gel-like substance in the intestines, adding bulk to the stool and promoting regular bowel movements. This bulking effect helps to normalize the consistency of the stool, reducing the frequency and severity of diarrhea episodes. Additionally, psyllium husk acts as a gentle laxative, softening the stool and easing its passage through the digestive system. Its ability to absorb excess water also aids in reducing the fluidity of stools, providing relief from the discomfort associated with diarrhea. Moreover, psyllium husk has been shown to have a soothing effect on the intestinal lining, which can be beneficial for individuals experiencing inflammation or irritation due to diarrhea. It can help to alleviate abdominal cramping and promote overall gastrointestinal health.



## 2. Probiotics

Probiotics, which are live bacteria and yeasts that are beneficial for gut health, have been studied for their potential to alleviate diarrhea symptoms and promote recovery. These beneficial microorganisms work by restoring the natural balance of bacteria in the gut, which can be disrupted during episodes of diarrhea. By colonizing the intestines and competing with harmful bacteria, probiotics help to enhance the immune response, reduce inflammation, and improve overall gut function. Several strains of probiotics, such as Lactobacillus and Bifidobacterium, have shown promising results in managing acute infectious diarrhea, antibiotic-associated diarrhea, and diarrhea associated with irritable bowel syndrome. While further research is still needed to determine the most effective strains, dosage, and duration of probiotic use for diarrhea management, current evidence suggests that probiotics can be a valuable adjunct therapy.

**Ingredients:** See Supplement Facts.

**Manufacturer Country:** USA

**Product Amount:** 60 caps

**Gross Weight:** 0.25lb (113g)

**Suggested Use:** Take two (2) capsules once a day as a dietary supplement. For best results, take one (1) capsule during the day and one (1) capsule in the evening. Repeat the process daily. Do not exceed two capsules per day.

**Warning:** Keep out of reach of children. Do not use if the safety seal is damaged or missing. Store in a cool, dry place.



### 3. Birch Chaga Truffles

Birch chaga truffles have been used for centuries as a natural remedy for various health conditions, including diarrhea. Diarrhea is a common gastrointestinal disorder characterized by loose, watery stools, and it can be caused by various factors such as viral or bacterial infections, food poisoning, or even stress. Birch chaga truffles, also known as *Inonotus obliquus* or “the diamond of the forest,” are a type of medicinal mushroom that grows on birch trees in cold climates. These truffles are packed with bioactive compounds, including polysaccharides, antioxidants, and betulinic acid, which contribute to their therapeutic properties. When it comes to diarrhea, birch chaga truffles can help alleviate symptoms and promote gastrointestinal health in several ways. Firstly, their high fiber content can add bulk to the stool, reducing the frequency of bowel movements and providing relief from diarrhea. Additionally, the antioxidants present in chaga truffles help reduce inflammation in the gut, which can be beneficial in cases of diarrhea caused by inflammation. Moreover, the immune-boosting properties of chaga truffles can strengthen the body’s defense mechanisms, helping it fight off the underlying causes of diarrhea more effectively.

**Ingredients:** Dates, Linseed Flour, Birch Chaga, Wood Extract (*Inonotus obliquus*), cacao. High content of polyphenols.

**Flavor:** Chocolate

**Manufacturer Country:** Latvia

**Product Amount:** 30 truffles

**Gross Weight:** 0.4lb (181g)

**Suggested Use:** 1 truffle a day. Do not use a dietary supplement to replace a complete and balanced diet. Do not exceed the recommended daily dose. Store at room temperature out of the reach of children.

**Warning:** Keep out of reach of children. Do not use if the safety seal is damaged or missing. Store in a cool, dry place.



### 10. GERD (GASTROESOPHAGEAL REFLUX DISEASE)

Gastroesophageal reflux disease, referred to as GERD or sometimes simply acid reflux or heartburn, is a condition in which the digestive juices in the stomach make contact with the esophagus. The lining of the stomach is coated with a thick mucus that prevents the digestive juices from burning or damaging the walls of the stomach. This acid is incredibly acidic, and if it comes into contact with other parts of our digestive tract like the esophagus, it can lead to a burning sensation. This is what’s going on when you’re experiencing heartburn. The main difference between GERD and simple heartburn is that people without GERD tend to experience heartburn fairly rarely, while people with GERD tend to experience symptoms a couple times a week. GERD also encompasses people with severe acid reflux that occurs on almost a daily basis. One of the best ways to combat the problem is to identify what foods and situations lead to you experiencing heartburn. There are over-the-counter medications that can help with symptoms of GERD. In very serious cases, people may need surgery or prescribed medications to help them manage the condition. If you’re wondering whether or not you’re suffering from GERD, then read this list of symptoms. It should be helpful for you to identify whether or not you’ve got the problem so you can decide whether or not you need to seek treatment.

## # Symptoms

The main symptom of GERD is heartburn, which leads to a sensation of burning in the throat. This occurs with the digestive juices that are normally kept in the stomach flow upwards and cause irritation and pain in the esophagus. This symptom can usually be managed by carefully observing your diet and figuring out what foods that you're eating are causing heartburn. Over-the-counter antacids can also be very useful in minimizing the discomfort associated with heartburn. It can be hard for someone with GERD to swallow, especially when they are experiencing an attack of heartburn. Swallowing activates the esophagus, which is essentially a long tube of muscle that draws food from the mouth down into the stomach. Swallowing causes these muscles to contract, which can be quite uncomfortable for someone who is experiencing burning in their esophagus. This can make it difficult or unpleasant to eat food for these people. Regurgitation is a process that is fairly similar to vomiting, the main difference being that vomiting is generally an attempt of your body to purge what's in your stomach and regurgitation is purging what is within the esophagus. People with serious GERD can sometimes have a hard time keeping food down and may regurgitate it quickly after swallowing it. In some cases, food may not even make it all the way down the esophagus before being regurgitated.

### Common signs and symptoms of GERD include:

- A burning sensation in your chest (heartburn), usually after eating, which might be worse at night or while lying down
- Backwash (regurgitation) of food or sour liquid
- Upper abdominal or chest pain
- Trouble swallowing (dysphagia)
- Sensation of a lump in your throat

### If you have nighttime acid reflux, you might also experience:

- An ongoing cough
- Inflammation of the vocal cords (laryngitis)
- New or worsening asthma

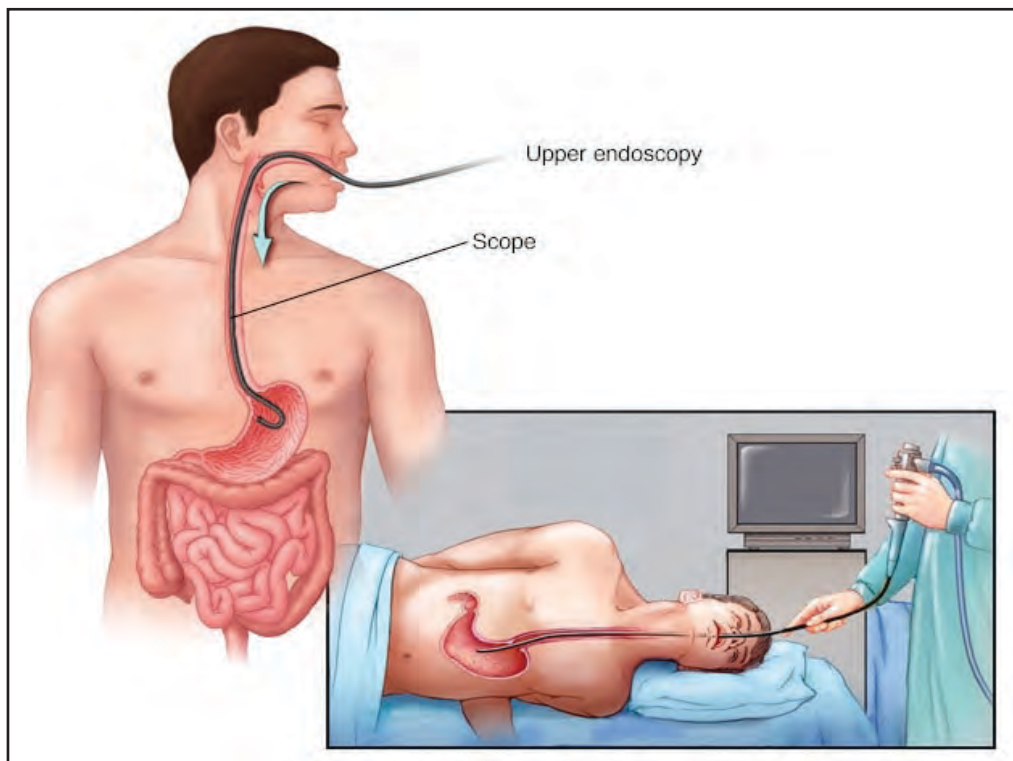

**The recommended supplements for GERD are:** Sleep Well, Probiotics, & L-Glutamine Powder.

## 1. Sleep Well

Sleep Well supplements for GERD are designed to help individuals suffering from gastroesophageal reflux disease (GERD) achieve a more restful and uninterrupted sleep. GERD is a chronic digestive disorder that causes the stomach acid to flow back into the esophagus, leading to symptoms such as heartburn, regurgitation, and difficulty swallowing. These symptoms can often worsen at night, making it challenging for individuals with GERD to get a good night's sleep. Sleep Well supplements are formulated with natural ingredients that aim to alleviate the symptoms of GERD and promote better sleep quality. Ingredients such as melatonin, Passiflora Incarnata are commonly found in these supplements, as they are known for their calming and soothing properties. Melatonin, a hormone naturally produced by the body, helps regulate sleep-wake cycles, while chamomile and valerian root have been used for centuries as natural remedies for sleep disorders. By combining these ingredients, Sleep Well supplements not only help individuals with GERD reduce their acid reflux symptoms but also promote relaxation and induce a sense of calmness, making it easier to fall asleep and stay asleep throughout the night. Moreover, these supplements are often formulated to be gentle on the stomach, ensuring that they do not exacerbate GERD symptoms or cause any discomfort. It is important to note that while Sleep Well supplements can be beneficial for individuals with GERD, they should not replace proper medical treatment or lifestyle modifications recommended by healthcare professionals.

**Ingredients:** see Supplement Facts.

**Manufacturer Country:** USA

**Product Amount:** 60 gummies

**Gross Weight:** 0.56lb (255g)

**Suggested Use:** Take two (2) capsules once a day as a dietary supplement.

**Caution:** Do not exceed recommended dose. Pregnant or nursing mothers, children under the age of 18, and individuals with a known medical condition should consult a physician before using this or any dietary supplement.

**Warning:** This product is not intended to diagnose, treat, cure or prevent any disease. Keep out of reach of children. Do not use if the safety seal is damaged or missing. Store in a cool, dry place.

**DrSous.Ca Sleep Well Gummies (Adult)**  
Regular price: \$23.90 CAD  
Product Amount: 60 gummies  
Gross Weight: 0.56lb (255g)  
Sleep is an essential part of life and some people may have difficulty in sleeping. Sleep Well Gummies are designed to improve sleep and relaxation. It is a blend of Passiflora incarnata & Melatonin both of which assists in enhancing the quality and amount of sleep.

**Supplement Facts**  
Serving Size: 2 Gummies  
Amount Per Serving: 2Gummies

	Amount Per Serving	% Daily Value
Melatonin	3.5mg	70%
Passiflora Incarnata	100mg	100%
Chamomile	100mg	100%
Valerian Root	100mg	100%
Other Ingredients		

Paradise Wellness  
A specific channel for Sleep well on YouTube

Dr. Sous  
www.drsous.ca

## 2. Probiotics

Probiotics supplements have gained significant attention as a potential remedy for GERD, or gastroesophageal reflux disease. GERD is a chronic condition characterized by the backward flow of stomach acid into the esophagus, causing symptoms like heartburn, regurgitation, and chest pain. While traditional treatments for GERD typically involve medications that reduce stomach acid production, probiotics offer a more natural and holistic approach. Probiotics are live bacteria and yeasts that are beneficial to the human body, particularly the digestive system. They work by restoring the balance of gut bacteria, which can be disrupted in individuals with GERD. Studies have shown that certain strains of probiotics, such as Lactobacillus and Bifidobacterium, can help alleviate GERD symptoms by improving the function of the lower esophageal sphincter, which is responsible for preventing stomach acid from flowing back into the esophagus. Additionally, probiotics can help reduce inflammation in the digestive tract, strengthen the immune system, and promote

overall gut health.

**Ingredients:** See Supplement Facts.

**Manufacturer Country:** USA

**Product Amount:** 60 caps

**Gross Weight:** 0.25lb (113g)

**Suggested Use:** Take two (2) capsules once a day as a dietary supplement. For best results, take one (1) capsule during the day and one (1) capsule in the evening. Repeat the process daily. Do not exceed two capsules per day.

**Warning:** Keep out of reach of children. Do not use if the safety seal is damaged or missing. Store in a cool, dry place.

**DrSous.Ca Probiotic 40 Billion with Prebiotics**  
Regular price: \$27.00 CAD  
Product Amount: 60 caps  
Gross Weight: 0.25lb (113g)

Probiotic 40 Billion with Prebiotics is a blend of four probiotic strains: Lactobacillus Acidophilus, Bifidobacterium Lactis, Lactobacillus Plantarum, and Lactobacillus Paracasei. Together, they provide a high level of beneficial bacteria to the gut to support a healthy metabolic response for both men and women.

Supplement Facts	
Serving Size: 2 Capsules	
Servings Per Container: 30	
Amount Per Serving	
Probiotic Blend (40 Billion CFU)	40 Billion CFU
Lactobacillus Acidophilus	10.0 Billion
Bifidobacterium Lactis	10.0 Billion
Lactobacillus Plantarum	10.0 Billion
Lactobacillus Paracasei	10.0 Billion
Prebiotic Blend	10.0 Billion

Other Ingredients: Cellulose, Starch, Capsules, Riboflavin, Lactose.

### 3. L-Glutamine Powder

L-Glutamine Powder supplements have gained attention as a potential remedy for GERD (Gastroesophageal Reflux Disease), a condition characterized by the backward flow of stomach acid into the esophagus. GERD is often associated with symptoms such as heartburn, regurgitation, and difficulty swallowing, which can significantly impact an individual's quality of life. L-Glutamine, a non-essential amino acid, is known for its role in promoting gut health and aiding in the repair of damaged tissues. It is believed that L-Glutamine Powder supplements may help alleviate GERD symptoms by strengthening the lining of the esophagus and reducing inflammation. Additionally, L-Glutamine has been shown to support the function of the lower esophageal sphincter (LES), a muscular valve that prevents stomach acid from flowing back into the esophagus. This may help prevent acid reflux episodes and provide relief for those suffering from GERD.

**Ingredients:** see Supplement Facts.

**Flavor:** Unflavored

**Manufacturer Country:** USA

**Product Amount:** 0.66lb (300g)

**Gross Weight:** 0.7lb (205g)

**Suggested Use:** 1 serving 1 to 2 times daily with a beverage of choice or as directed by a health-care professional.

**Caution:** Do not exceed recommended dose. Pregnant or nursing mothers, children under 18 years of age, and individuals with a known medical condition should consult a physician before using this or any dietary supplement. This product is manufactured and packaged in a facility that may also process milk, soy, wheat, egg, peanuts, tree nuts, fish, and crustacean shellfish.

**Warning:** Keep out of reach of children. Do not use if the safety seal is damaged or missing. Store in a cool, dry place.

**DRSOUS.CA L-Glutamine Powder supports lean muscle mass and cell growth**  
Regular price: \$46.00 CAD  
Product Amount: 0.66lb (300g)  
Gross Weight: 0.7lb (205g)

L-Glutamine Powder supplementation is crucial for the body throughout exercise and sporting activities.

L-Glutamine supports lean muscle mass, cell growth, and growth hormone release in the body, which is essential for improved performance.

- Enhances muscular strength
- Increases athletic performance
- Anti-fatigue

**Effective immune-booster**

Supplement Facts	
Serving Size 2 Grams (approximately 1/2 tsp)	
Servings Per Container: 150	
Amount Per Serving	%Daily Value
L-Glutamine Powder	2 grams
*Daily Value not established.	

Vendor Code: LGU100-V02

## IX. RESPIRATORY CONDITION

What Are the Parts of the Respiratory System? The respiratory system includes the nose, mouth, throat, voice box, windpipe, and lungs. Air enters the respiratory system through the nose or the mouth. If it goes in the nostrils (also called nares), the air is warmed and humidified.

What are the 7 main parts of the respiratory system?

### Respiratory system

- Nose.
- Mouth.
- Throat (pharynx)
- Voice box (larynx)
- Windpipe (trachea)
- Large airways (bronchi)
- Small airways (bronchioles)
- Lungs.

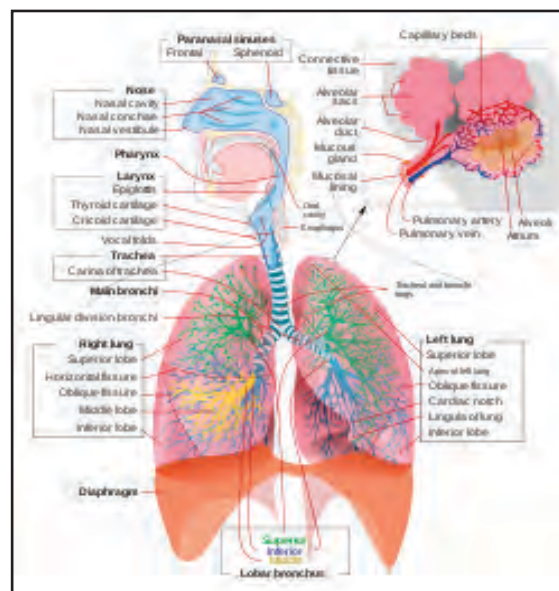

**The respiratory system (also respiratory apparatus, ventilator system)** is a biological system consisting of specific organs and structures used for gas exchange in animals and plants. The anatomy and physiology that make this happen varies greatly, depending on the size of the organism, the environment in which it lives and its evolutionary history. In land animals the respiratory surface is internalized as linings of the lungs. Gas exchange in the lungs occurs in millions of small air sacs; in mammals and reptiles these are called alveoli, and in birds they are known as atria. These microscopic air sacs have a very rich blood supply, thus bringing the air into close contact with the blood. These air sacs communicate with the external environment via a system of airways, or hollow tubes, of which the largest is the trachea, which branches in the middle of the chest into the two main bronchi. These enter the lungs where they branch into progressively narrower secondary and tertiary bronchi that branch into numerous smaller tubes, the bronchioles. In birds the bronchioles are termed parabronchi. It is the bronchioles, or parabronchi that generally open into the microscopic alveoli in mammals and atria in birds. Air has to be pumped from the environment into the alveoli or atria by the process of breathing which involves the muscles of respiration.

## 1. ASTHMA

Shortness of breath is one of the most common symptoms of asthma. The muscles around the airways tense, causing the airways to narrow, which can result in bronchospasms and airway inflammation. The body creates mucus to address this reaction, and the lungs become less efficient in transferring oxygen to the small blood vessels on the surface of the lungs. Asthma-induced coughing is often most prevalent at night, usually manifesting as a dry cough that does not expel mucus. This symptom can disrupt sleep, leaving affected individuals fatigued the next day. Experts have yet to reach a consensus regarding exactly what causes the cough to worsen during the night. Some theorize it may be a result of increased exposure to allergens, the sleep position, or hormones secreted at night. Sleeping with the head of the bed raised helps prevent coughing due to asthma. Wheezing often develops in conjunction with shortness of breath, coughing, and tightness in the chest. People with asthma may develop an audible whistling noise when they inhale and exhale. This symptom is not exclusive to asthma; many respiratory conditions can cause wheezing. While many people find cigarette smoke intolerable, second-hand smoke can severely affect people with asthma. The chemicals in cigarette smoke irritate the lungs, causing constriction of the airways. Medical evidence suggests that these chemicals can cause more lasting damage. Car exhaust fumes and pollutants in the air can cause similar irritation.

### # Symptoms

- Shortness of breath.
- Chest tightness or pain.
- Wheezing when exhaling, which is a common sign of asthma in children.
- Trouble sleeping caused by shortness of breath, coughing or wheezing.
- Coughing or wheezing attacks that are worsened by a respiratory virus, such as a cold or the flu.

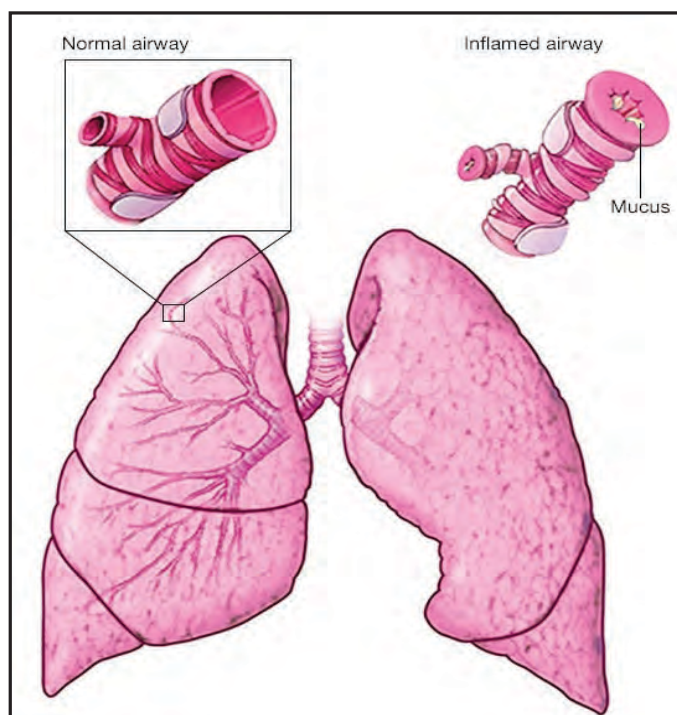

**The most recommended supplements for asthma are:** Bee Pearl pollen, Ginkgo Biloba + Ginseng, & Platinum Turmeric.

### 1. Bee Pearl Pollen

Bee pollen has long been recognized for its potential health benefits, and one area where it has shown promise is in the management of asthma symptoms. Asthma is a chronic respiratory condition characterized by inflammation and narrowing of the airways, leading to symptoms such as wheezing, coughing, and shortness of breath. Bee pollen, specifically Bee Pearl pollen, has gained attention for its potential anti-inflammatory properties and ability to support respiratory health. Rich in vitamins, minerals, enzymes, and antioxidants,



Bee Pearl pollen is a natural substance collected by bees from flowering plants. It is believed to possess anti-inflammatory and immunomodulatory effects, which can help reduce airway inflammation and improve breathing in individuals with asthma. Furthermore, Bee Pearl pollen is thought to strengthen the immune system, making it more resilient against respiratory infections and allergens that can trigger asthma symptoms.

**Ingredients:** see Supplement Facts.

**Manufacturer Country:** Latvia

**Product Amount:** 30 caps

**Gross Weight:** 0.11lb (50g)

**Suggested Use:** One (1) capsule per day during the main meal or immediately after it with a glass of water. Suitable for vegetarians.

**Caution:** Recommended to anyone who is not allergic to bee products. If you are prone to allergic reactions, consult a doctor or pharmacist before use. Do not exceed the recommended daily dose. Do not use on an empty stomach. Consult a doctor or pharmacist before using this product during pregnancy or when breastfeeding. Do not use after the expiry of the validity period. Do not use food supplements as a substitute for a diverse and balanced diet. Keep out of reach and sight of children. Store at room temperature from +15C to +25C in a dry place, away from direct sunlight.

**Warning:** This product is not intended to diagnose, treat, cure or prevent any disease. Do not use if the safety seal is damaged or missing. Store in a cool, dry place.



## 2. Ginkgo Biloba + Ginseng

Ginkgo Biloba and ginseng are two popular herbal supplements that have been used for centuries in traditional medicine. While they are often associated with cognitive benefits and energy enhancement, recent studies have also suggested their potential in managing asthma symptoms. Ginkgo Biloba, derived from the leaves of the Ginkgo tree, is known for its antioxidant properties and anti-inflammatory effects. These properties may help reduce airway inflammation in asthma patients, leading to improved breathing and decreased symptoms. Ginseng, on the other hand, is a root herb that is believed to boost the immune system and reduce inflammation. By modulating the immune response, ginseng may help alleviate the severity of asthma attacks and improve lung function. Additionally, both Ginkgo Biloba and ginseng have been shown to have bronchodilatory effects, meaning they can help relax and widen the airways, making it easier for individuals with asthma to breathe. While conventional treatment options such as bronchodilators and corticosteroids are effective in controlling asthma symptoms, some individuals seek alternative therapies like Ginkgo Biloba to enhance their respiratory health.

**Ingredients:** See Supplement Facts.

**Manufacturer Country:** USA

**Product Amount:** 60 caps

**Gross Weight:** 0.25lb (133g)

**Suggested Use:** As a dietary supplement, take two (2) capsules before bedtime or as directed by your healthcare professional.

**Warning:** Keep out of reach of children. Do not use if the safety seal is damaged or missing. Store in a cool, dry place.



### 3. Platinum Turmeric

Platinum Turmeric supplement has gained significant attention as a potential remedy for asthma. Asthma, a chronic respiratory condition characterized by inflammation and narrowing of the airways, affects millions of people worldwide. Turmeric, a vibrant yellow spice commonly used in Asian cuisine, contains a bioactive compound called curcumin, which has been extensively studied for its anti-inflammatory and antioxidant properties. These properties make turmeric an intriguing candidate for managing asthma symptoms. Platinum Turmeric supplement offers a concentrated form of curcumin, allowing individuals to potentially harness its therapeutic effects. Studies have shown that curcumin can inhibit the production of pro-inflammatory molecules and modulate immune responses, thus reducing airway inflammation and improving lung function. Additionally, curcumin's antioxidant properties may help neutralize harmful free radicals, which can cause oxidative stress and contribute to asthma exacerbations.

**Ingredients:** see Supplement Facts.

**Manufacturer Country:** USA

**Product Amount:** 60 caps

**Gross Weight:** 0.25lb (113g)

**Suggested Use:** Take two (2) capsules once a day as a dietary supplement. For best results, take 20-30 min before a meal or as directed by your healthcare professional.

**Caution:** Consult a physician before use if you have any medical conditions. Glucosamine is derived from shellfish. People allergic to shellfish should not consume this product.

**Warning:** Keep out of reach of children. Do not use if the safety seal is damaged or missing. Store in a cool, dry place.



## 2. COPD (CHRONIC OBSTRUCTIVE PULMONARY DISEASE)

Chronic obstructive pulmonary disease (COPD) is a common lung disease causing restricted airflow and breathing problems. Emphysema and chronic bronchitis are the two most common conditions that contribute to COPD. These two conditions usually occur together and can vary in severity among individuals with COPD. Chronic bronchitis is inflammation of the lining of the bronchial tubes, which carry air to and from the air sacs (alveoli) of the lungs. It's characterized by daily cough and mucus (sputum) production. Emphysema is a condition in which the alveoli at the end of the smallest air passages (bronchioles) of the lungs are destroyed as a result of damaging exposure to cigarette smoke and other irritating gases and particulate matter. Although COPD is a progressive disease that gets worse over time, COPD is treatable. With proper management, most people with COPD can achieve good symptom control and quality of life, as well as reduced risk of other associated conditions.

### Causes

The main cause of COPD in developed countries is tobacco smoking. In the developing world, COPD often occurs in people exposed to fumes from burning fuel for cooking and heating in poorly ventilated homes.

### Symptoms

In people with COPD, the lungs can get damaged or clogged with phlegm. Symptoms include cough, sometimes with phlegm, difficulty breathing, wheezing and tiredness.

### Chronic Cough

People with COPD usually develop a persistent cough that does not subside for weeks, months, or years. The cough is similar to a smoker's cough, and many long-term smokers assume the symptom is simply a by-product of their habit, which can lead to a delayed diagnosis.

### Mucus

Another distinctive symptom of COPD is excessive mucus production. The sputum may be transparent, white, pale green, or yellowish, although yellow or green sputum can also be a sign of an infection in the lungs or airways. People with COPD are at a higher risk of developing lung infections. In some cases, this sign does not develop until the condition is more advanced. The mucus causes congestion and can result in breathing difficulties, primarily upon waking. Mucus production tends to get worse as the disease advances.

### Tightness in Chest

Another common symptom associated with COPD is tightness in the chest, especially when inhaling, making breathing labored. Chest tightness differs from chest pain, which is not a common symptom of COPD. Individuals experiencing chest pain and tightness should see a doctor, who can test for heart and other lung or respiratory conditions.

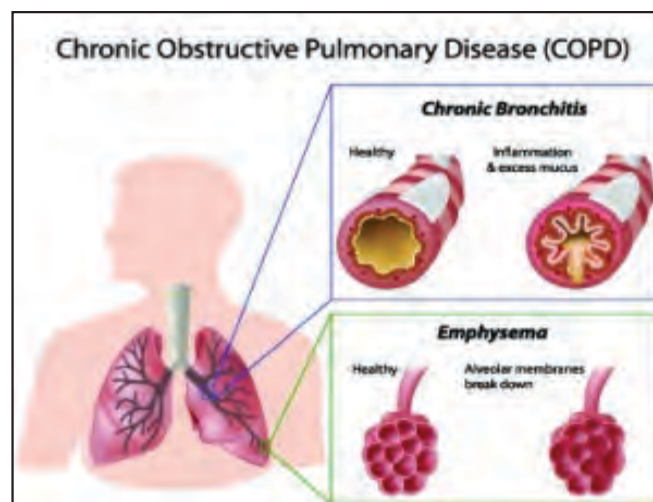

## Causes of airway obstruction

### Causes of airway obstruction include:

- **Emphysema.** This lung disease causes destruction of the fragile walls and elastic fibers of the alveoli. Small airways collapse when you exhale, impairing airflow out of your lungs.
- **Chronic bronchitis.** In this condition, your bronchial tubes become inflamed and narrowed and your lungs produce more mucus, which can further block the narrowed tubes. You develop a chronic cough trying to clear your airways.

**The most recommended supplements for COPD are:** Vitamin D3, Magnesium Glycinate, & CoQ10.

### 1. Vitamin D3

Vitamin D3 has gained significant attention in recent years for its potential benefits in managing chronic obstructive pulmonary disease (COPD). COPD is a progressive lung disease characterized by airflow limitation, inflammation, and oxidative stress. Research suggests that vitamin D3 may play a crucial role in improving lung function and reducing the severity of COPD symptoms. Vitamin D3 is known to have anti-inflammatory properties, which can help reduce the inflammation in the airways and lungs that occurs in COPD. It also has immunomodulatory effects, meaning it can regulate the immune response and potentially decrease the frequency and severity of exacerbations in COPD patients. Moreover, vitamin D3 is involved in calcium and phosphorus metabolism, which are essential for maintaining bone health. COPD patients often experience bone loss and osteoporosis due to systemic inflammation and the use of corticosteroids, making vitamin D3 supplementation even more important. Additionally, studies have shown that vitamin D deficiency is prevalent in COPD patients, suggesting a potential link between low vitamin D levels and the development and progression of the disease. Supplementation with vitamin D3 has been found to improve lung function, reduce systemic inflammation, and enhance exercise performance in COPD patients.

**Ingredients:** see Supplement Facts.

**Manufacturer Country:** USA

**Product Amount:** 100 soft-gels

**Gross Weight:** 0.1lb (45g)

**Suggested Use:** As a dietary supplement, adults take one (1) softgel capsule daily or as directed by a health care professional. Store in a cool, dry place and away from direct light.

**Warning:** Keep out of reach of children. Do not use if the safety seal is damaged or missing. Store in a cool, dry place.



### 2. Magnesium Glycinate

Magnesium is an essential mineral that plays a vital role in various physiological processes, including muscle function, nerve transmission, and immune system regulation. Research suggests that magnesium deficiency is prevalent among COPD patients and may contribute to the progression of the disease. Magnesium Glycinate, a highly bioavailable form of magnesium, has shown promising results

in managing COPD symptoms and improving lung function. This compound has been found to have anti-inflammatory properties, which can help alleviate airway inflammation and reduce the frequency and severity of exacerbations in COPD patients. Furthermore, magnesium glycinate has been shown to enhance lung function by relaxing the smooth muscles surrounding the airways, thereby improving airflow and reducing respiratory distress. It also acts as a bronchodilator, which can help open up the airways and facilitate better breathing. Additionally, magnesium glycinate may aid in reducing oxidative stress and improving immune function, both of which are crucial for COPD management.



### 3. CoQ10

Coenzyme Q10, commonly known as CoQ10, has gained attention as a potential supplement for individuals suffering from chronic obstructive pulmonary disease (COPD). COPD is a progressive lung disease that causes breathing difficulties and reduced airflow. It has been observed that individuals with COPD often have lower levels of CoQ10 in their blood, leading to speculation about the role CoQ10 may play in managing this condition. CoQ10 is an antioxidant that is naturally produced in the body and is involved in the production of energy within cells. It is also known for its ability to protect against oxidative stress, which is a major contributor to the development and progression of COPD. Research studies have shown that supplementing with CoQ10 may help improve lung function, reduce inflammation, and enhance exercise tolerance in individuals with COPD. Additionally, CoQ10 has been found to have a positive impact on the immune system, which is crucial for individuals with COPD as they are more susceptible to infections and respiratory complications.

**Ingredients:** see Supplement Facts.

**Manufacturer Country:** USA

**Product Amount:** 30 caps

**Gross Weight:** 0.25lb (113g)

**Suggested Use:** Take one (1) capsule twice a day as a dietary supplement. For best results, take 20-30 min before a meal or as directed by your healthcare professional.

**Caution:** Do not exceed recommended dose. Pregnant or nursing mothers, children under the age of 18, and individuals with a known medical condition should consult a physician before using this or any dietary supplement.

**Warning:** Keep out of reach of children. Do not use if the safety seal is damaged or missing. Store in a cool, dry place.



### 3. CYSTIC FIBROSIS

Cystic fibrosis is an inherited condition that causes sticky mucus to build up in the lungs and digestive system. This causes lung infections and problems with digesting food. The mucus causes problems in the lungs, pancreas, and other organs. People with cystic fibrosis get lung infections often. Over time, they have more trouble breathing.

#### What causes someone to get cystic fibrosis?

Cystic fibrosis is a genetic disease. People with CF have inherited two copies of the defective CF gene one copy from each parent. Both parents must have at least one copy of the defective gene. People with only one copy of the defective CF gene are called carriers, but they do not have the disease.

#### # Symptoms

##### 1. Early Symptoms

Symptoms are often noticeable straight after birth. Bowel blockages are very common, as is an overly salty taste to the skin. Parents often notice the latter when kissing their child. Typically, children don't gain weight as expected, and they may also have jaundice although this is a very common condition that affects numerous babies, not just those with cystic fibrosis. Those who suspect their child has cystic fibrosis should consider asking for a medical screening to ensure that their little one gets the right treatment from an early age.

##### 2. Damage to Lungs

The lungs are a major organ in the body, but they are also most vulnerable to the mucus generated by cystic fibrosis. Because the tubes that absorb oxygen from the air are so fine, they can be blocked relatively easily. Furthermore, the mucus forms a fertile breeding ground for bacteria, resulting in illness. Chest infections and bronchial infections are very common, as a shortness of breath and a pronounced wheeze. Continuous infection can result in the lungs not working properly.

##### 3. Harm to the Digestive System

Cystic fibrosis often causes extensive damage to the digestive system as well. The sticky mucus can prevent food from passing smoothly to the body, and it may also prevent adequate digestion. Those with cystic fibrosis often end up with vitamin and mineral deficiencies and may also be technically malnourished, even if they are eating well.

##### 4. Difficulties in Conceiving Children

Cystic fibrosis often causes trouble when attempting to conceive. For men, this difficulty is physical, because they don't have the canal that connects the testicles to the penis, the vas deferens. Because sperm cannot travel, they are essentially shooting blanks. This occurs in around 98 percent of men with cystic fibrosis. Women with this condition may find that the mucus that the condition generates blocks up various parts of their body. If the mucus forms in the cervix or the fallopian tubes, it can prevent sperm from physically interacting with the egg, a process that's required for conception.

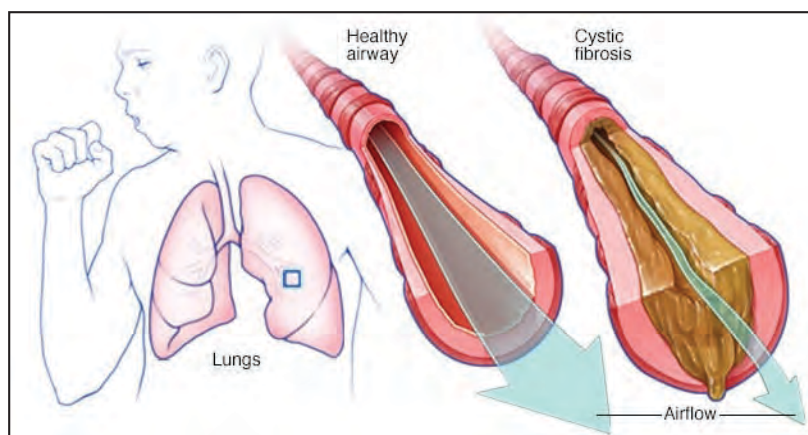

The most recommended supplements for cystic fibrosis are: Probiotic 40, Vitamin D3, & CoQ10.

## 1. Probiotics

Probiotics have gained attention in recent years for their potential benefits in managing various health conditions, including cystic fibrosis (CF). Cystic fibrosis is a genetic disorder that affects the lungs, digestive system, and other organs. It is characterized by the production of thick, sticky mucus that can obstruct airways and lead to respiratory infections. While probiotics are commonly known for their positive effects on gut health, their potential role in CF lies in their ability to modulate the immune system and enhance overall wellbeing. Studies investigating the use of probiotics in CF patients have shown promising results. Probiotics, such as Lactobacillus and Bifidobacterium strains, have been found to improve lung function, reduce inflammation, and enhance the nutritional status of individuals with CF. These beneficial effects may be attributed to the ability of probiotics to restore gut microbial balance and reduce the risk of bacterial overgrowth, which is common in CF patients. Furthermore, probiotics may help prevent the colonization of harmful bacteria in the lungs, thus reducing the risk of respiratory infections.

**Ingredients:** See Supplement Facts.

**Manufacturer Country:** USA

**Product Amount:** 60 caps

**Gross Weight:** 0.25lb (113g)

**Suggested Use:** Take two (2) capsules once a day as a dietary supplement. For best results, take one (1) capsule during the day and one (1) capsule in the evening. Repeat the process daily. Do not exceed two capsules per day.

**Warning:** Keep out of reach of children. Do not use if the safety seal is damaged or missing. Store in a cool, dry place.



## 2. Vitamin D3

Vitamin D3 has emerged as a potential therapeutic option for individuals with cystic fibrosis (CF), a genetic disorder that primarily affects the lungs and digestive system. CF patients often experience chronic inflammation and respiratory infections, which can lead to lung damage over time. Research studies have shown that vitamin D3, also known as cholecalciferol, plays a crucial role in modulating the immune system and reducing inflammation. Furthermore, CF patients are at a higher risk of vitamin D deficiency due to impaired absorption of fat-soluble vitamins in the intestines. Supplementing with vitamin D3 has been found to improve lung function, reduce the frequency of pulmonary exacerbations, and enhance overall well-being in CF patients. Moreover, vitamin D3 has been shown to have antimicrobial properties, thereby potentially reducing the risk of respiratory infections. While further clinical trials are needed to establish the optimal dosage and long-term effects of vitamin D3 supplementation in CF patients, the existing evidence suggests that it may be a valuable adjunct therapy in managing this complex condition.

**Ingredients:** see Supplement Facts.

**Manufacturer Country:** USA

**Product Amount:** 100 soft-gels

**Gross Weight:** 0.1lb (45g)

**Suggested Use:** As a dietary supplement, adults take one (1) softgel capsule daily or as directed by a health care professional. Store in a cool, dry place and away from direct light.

**Warning:** Keep out of reach of children. Do not use if the safety seal is damaged or missing. Store in a cool, dry place.



### 3. CoQ10

Cystic fibrosis is a genetic disorder that affects the lungs, pancreas, and other organs. It is characterized by the production of thick, sticky mucus that can clog airways and lead to chronic lung infections. While there is no cure for cystic fibrosis, various treatments aim to manage the symptoms and improve the quality of life for those affected. One potential therapeutic option that has gained attention in recent years is Coenzyme Q10, also known as CoQ10. CoQ10 is a naturally occurring compound found in the mitochondria, the energy-producing centers of our cells. It plays a crucial role in the production of adenosine triphosphate (ATP), which provides the energy needed for cellular function. Research suggests that individuals with cystic fibrosis may have lower levels of CoQ10, which could contribute to the oxidative stress and inflammation commonly observed in the disease. As a result, there has been growing interest in exploring the potential benefits of CoQ10 supplementation for individuals with cystic fibrosis. Although the exact mechanisms of action are not yet fully understood, several studies have shown promising results. CoQ10 supplementation has been associated with improved lung function, reduced oxidative stress, and decreased inflammation in individuals with cystic fibrosis. Additionally, some research suggests that CoQ10 may enhance the effectiveness of other treatments, such as antibiotics, by improving their delivery to the affected tissues.

**Ingredients:** see Supplement Facts.

**Manufacturer Country:** USA

**Product Amount:** 30 caps

**Gross Weight:** 0.25lb (113g)

**Suggested Use:** Take one (1) capsule twice a day as a dietary supplement. For best results, take 20-30 min before a meal or as directed by your healthcare professional.

**Caution:** Do not exceed recommended dose. Pregnant or nursing mothers, children under the age of 18, and individuals with a known medical condition should consult a physician before using this or any dietary supplement.

**Warning:** Keep out of reach of children. Do not use if the safety seal is damaged or missing. Store in a cool, dry place.





#### 4) PNEUMONIA

Pneumonia is a common lung infection caused by germs, such as bacteria, viruses, and fungi. It can be a complication of the flu, but other viruses, bacteria and even fungi can cause pneumonia. Pneumonia and its symptoms can vary from mild to severe.

- Cough, which may produce greenish, yellow or even bloody mucus.
- Fever, sweating and shaking chills.
- Shortness of breath.
- Rapid, shallow breathing.
- Sharp or stabbing chest pain that gets worse when you breathe deeply or cough.
- Loss of appetite, low energy, and fatigue.

#### # Symptoms

Many different germs can cause pneumonia, including bacteria, viruses, and fungi. When we breathe in these germs, we can usually fight them off with our immune system and cough them out of our lungs. However, some people have a weakened immune system or can't cough out the germs very well, and they end up getting an infection.

#### The main causes of pneumonia:

- Exposure to a germ (bacteria, virus, fungus)
- Weakened immune system
- Not able to cough out the germs/mucus from your lungs
- Pneumonia is occasionally caused by inhaling chemicals (fumes, liquids, particles) in the workplace.
- Unintentionally aspirating (inhaling) food or vomit into your lungs can cause "aspiration pneumonia".

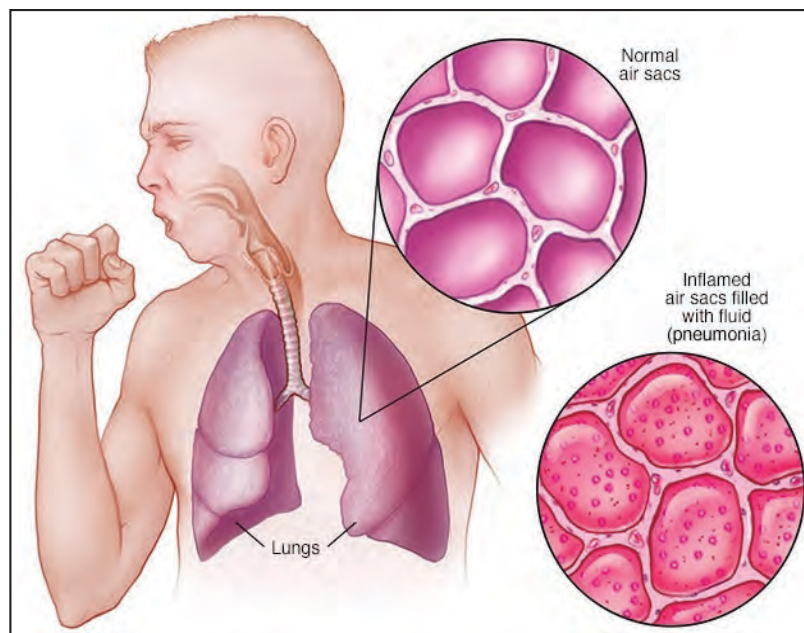

**The most recommended supplements for Pneumonia are:** Elderberry & Vitamin C, Vitamin D3, & Birch Chaga Microbiome.

#### 1. Elderberry & Vitamin C

Elderberry and Vitamin C supplements have gained popularity as potential remedies for various health conditions, including pneumonia. Pneumonia is a serious respiratory infection that affects the lungs and can cause severe symptoms such as coughing, difficulty breathing, and chest pain. Elderberry, derived from the berries of the Sambucus tree, is known for its immune-boosting properties. It contains high levels of antioxidants and has been traditionally used to alleviate flu symptoms. Some studies suggest that elderberry may help reduce the duration and severity of respiratory infections by inhibiting viral replication and modulating the immune response.

Vitamin C, on the other hand, is a powerful antioxidant that plays a crucial role in supporting the immune system. It helps protect against oxidative stress, enhances the production of white blood cells, and promotes the body's natural defense mechanisms. While elderberry and Vitamin C supplements are not a substitute for medical treatment, they may help strengthen the immune system and potentially aid in the recovery process for individuals with pneumonia.

**Ingredients:** see Supplement Facts.

**Flavor:** Elderberry

**Manufacturer Country:** USA

**Product Amount:** 60 gummies

**Gross Weight:** 0.56lb (255g)

**Suggested Use:** Take two (2) gummies once a day as a dietary supplement.

**Caution:** Do not exceed recommended dose. Pregnant or nursing women, children under 18, and individuals with known medical conditions should consult their physician before taking.

**Warning:** Keep out of reach of children. Do not use if the safety seal is damaged or missing. Store in a cool, dry place.

**DRSOUS.CA Elderberry & Vitamin C Gummies**

Regular price: \$25.00 CAD  
 Product Amount: 60 gummies  
 Gross Weight: 0.56lb (255g)

Packed with immune-boosting nutrients, including Vitamin C, Zinc, and Elderberry, this gummy is a popular way to receive antioxidants and boost overall health.

- Immune boosting
- Overall health
- Eases cold and flu symptoms
- Improves iron absorption

	Amount Per Serving	% Daily Value
Serving Size: 2 Gummies		
Total Gummies	60	100%
Total Vitamin C	1000mg	2000%
Total Zinc	10mg	200%
Total Elderberry	1000mg	100%
Total Vitamin D	1000IU	200%
Total Omega-3	1000mg	200%
Total Probiotics	1000000000	100%
Total Collagen	1000mg	100%
Total Resveratrol	1000mg	100%
Total Quercetin	1000mg	100%
Total Selenium	1000mcg	200%
Total Magnesium	1000mg	200%
Total Boron	1000mcg	200%
Total Chromium	1000mcg	200%
Total Manganese	1000mcg	200%
Total Vanadium	1000mcg	200%
Total Silicon	1000mg	200%
Total Calcium	1000mg	200%
Total Phosphorus	1000mg	200%
Total Potassium	1000mg	200%
Total Sodium	1000mg	200%
Total Chloride	1000mg	200%
Total Magnesium	1000mg	200%
Total Zinc	1000mg	200%
Total Iron	1000mg	200%
Total Copper	1000mg	200%
Total Manganese	1000mg	200%
Total Selenium	1000mg	200%
Total Vanadium	1000mg	200%
Total Silicon	1000mg	200%
Total Calcium	1000mg	200%
Total Phosphorus	1000mg	200%
Total Potassium	1000mg	200%
Total Sodium	1000mg	200%
Total Chloride	1000mg	200%

Paradise Wellness A specific channel for Elderberry & Vitamin C on YouTube

Dr. Sous www.drsous.ca

## 2. Vitamin D3

Vitamin D3 supplementation has gained significant attention in recent years for its potential role in preventing and managing various health conditions, including pneumonia. Pneumonia is a respiratory infection that can be caused by bacteria, viruses, or fungi, leading to inflammation in the lungs. Vitamin D3, also known as the sunshine vitamin, is synthesized in the skin when exposed to sunlight and plays a crucial role in maintaining overall health and immune function. Research suggests that vitamin D3 supplementation may have a positive impact on respiratory health, including reducing the risk of respiratory tract infections like pneumonia. Several studies have indicated that individuals with vitamin D deficiency are more susceptible to respiratory infections and have a higher risk of developing severe pneumonia. Vitamin D3 has been shown to enhance the innate immune response by stimulating the production of antimicrobial peptides and modulating the inflammatory response. Additionally, it has been observed that vitamin D3 supplementation can improve lung function and reduce the severity and duration of respiratory infections.

**Ingredients:** see Supplement Facts.

**Manufacturer Country:** USA

**Product Amount:** 100 soft-gels

**Gross Weight:** 0.1lb (45g)

**Suggested Use:** As a dietary supplement, adults take one (1) softgel capsule daily or as directed by a health care professional. Store in a cool, dry place and away from direct light.

**Warning:** Keep out of reach of children. Do not use if the safety seal is damaged or missing. Store in a cool, dry place.

**DRSOUS.CA Vitamin D3 helps maintain bone density, strength and healthy cell growth**

Vitamin D3 is a fat-soluble vitamin that supports the growth and development of bones and teeth. It also plays an essential role in the functioning of the muscles and boosting energy levels in the body. The body naturally produces Vitamin D when exposed to sunlight, and you can also receive Vitamin D from some foods like oily fish. In the winter months, especially in colder regions, the body doesn't produce as much Vitamin D, which can lead to what's called 'seasonal depression.'

VITAMIN D3

www.paradisewellness.ca A specific channel for Supplements on YouTube

Dr. Sous www.drsous.ca



gious, but the infection can become active at any point.

**Active tuberculosis**, on the other hand, means that the person is contagious, transmitting the disease to others.

Tuberculosis can affect anyone at any age. It is believed that around one third of world's population have latent tuberculosis. The primary screening method for TB is the tuberculin skin test, while the treatment is with antibiotics. In some countries, BCG injections are given immediately after birth in order to vaccinate against tuberculosis. Tuberculosis symptoms include:

Those who are infected but not (yet) ill with the disease cannot transmit it. TB disease is usually treated with antibiotics and can be fatal without treatment.

### # Symptoms

Because tuberculosis mostly affects the lungs, then symptoms such as a cough, difficulty breathing, or chest pain are quite common. Lung tissue is affected due to the strong immune response elicited by the rapid multiplication of organisms. If the infection is not contained by the immune system, a persistent dry cough can develop. A persistent cough lasting for three weeks or longer should be a warning sign. First, the cough is dry and irritating, but as the disease progresses it tends to get worse, eventually resulting in the production of a lot of phlegm (sputum) and even the presence of blood. Another symptom of TB infection is the expectoration of blood or blood-tinged sputum, called hemoptysis. Generally, blood that originates from the lower bronchial tree or lung tissue induces cough, whereas expectoration without cough is more consistent with an upper respiratory source. Moreover, the lungs have a dual circulation- bronchial and pulmonary. As *Mycobacterium tuberculosis* enters the respiratory system it gets settled in the lungs where it starts multiplying and generating a vigorous immune response that results in lung tissue injury. Infection with *M. tuberculosis* generally causes bleeding from the pulmonary parenchyma (functional tissue). However, engorgement of dilated bronchial vessels and links (anastomoses) between both circulations, can also occur and lead to erosion and rupture of pulmonary capillaries and bronchial arteries. The overall management of hemoptysis is preventing aspiration of blood, bleeding cessation and treatment of underlying cause. Note that tuberculosis is not the sole cause of this symptom.

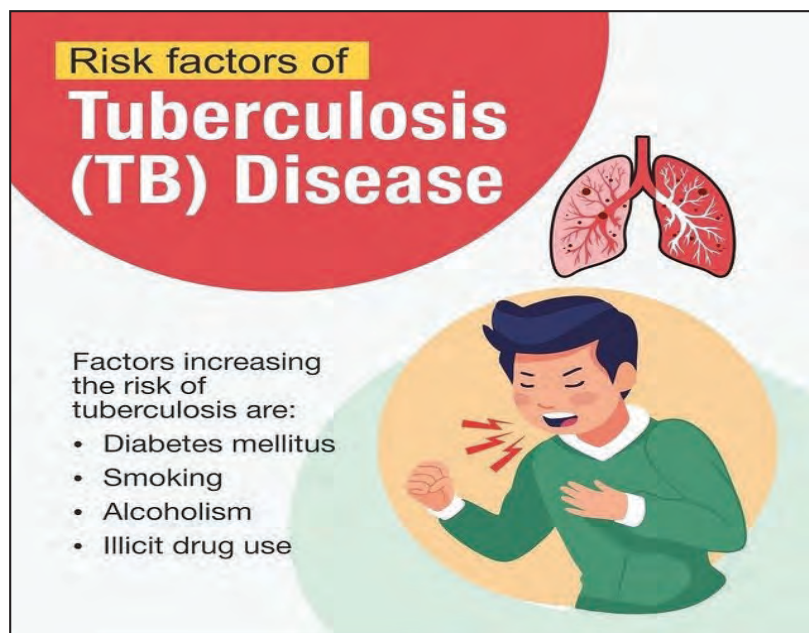

**The most recommended supplements for TB are:** Platinum Turmeric, Vitamin D3, & Ginkgo Biloba + Ginseng.

### 1. Platinum Turmeric

Turmeric, a vibrant yellow spice commonly found in Indian cuisine, has been gaining attention for its potential health benefits, particularly in the treatment of tuberculosis (TB). TB is an infectious disease caused by the bacteria *Mycobacterium tuberculosis*, primarily affecting the lungs but can also affect other parts of the body. Historically, turmeric has been used in traditional medicine systems like Ayurveda to treat various ailments due to its anti-inflammatory, antioxidant, and antimicrobial properties. Recent studies have shown

that curcumin, the active compound found in turmeric, exhibits promising effects against TB. Curcumin has been found to inhibit the growth of *Mycobacterium tuberculosis*, making it a potential adjunct therapy in the management of TB. It has also been reported to enhance the effectiveness of conventional anti-TB drugs, reducing the risk of drug resistance. Moreover, curcumin's immunomodulatory properties may help modulate the immune response, reducing inflammation and promoting healing in TB patients. However, it is important to note that while turmeric shows potential in the treatment of TB, it should not be considered as a standalone treatment. It should be used as a complementary therapy in conjunction with standard anti-TB medications, under the guidance of a healthcare professional.

**Ingredients:** see Supplement Facts.

**Manufacturer Country:** USA

**Product Amount:** 60 caps

**Gross Weight:** 0.25lb (113g)

**Suggested Use:** Take two (2) capsules once a day as a dietary supplement. For best results, take 20-30 min before a meal or as directed by your healthcare professional.

**Caution:** Consult a physician before use if you have any medical conditions. Glucosamine is derived from shellfish. People allergic to shellfish should not consume this product.

**Warning:** Keep out of reach of children. Do not use if the safety seal is damaged or missing. Store in a cool, dry place.



**Manufacturer Country:** USA

**Product Amount:** 100 soft-gels

**Gross Weight:** 0.11lb (45g)

**Suggested Use:** As a dietary supplement, adults take one (1) softgel capsule daily or as directed by a health care professional. Store in a cool, dry place and away from direct light.

**Warning:** Keep out of reach of children. Do not use if the safety seal is damaged or missing. Store in a cool, dry place.



### 3. Ginkgo Biloba + Ginseng

The potential benefits of using Ginkgo Biloba and Ginseng in TB treatment lie in their natural properties and historical usage in traditional medicine. Ginkgo Biloba is a well-known herb that has been used for centuries in Chinese medicine. It is believed to have anti-inflammatory and antioxidant properties, which may aid in reducing the inflammation and oxidative stress associated with TB. Additionally, Ginkgo Biloba has been shown to improve immune function, which is vital in combating tuberculosis. On the other hand, Ginseng is another herb with a long history of medicinal use. It is commonly used as an adaptogen, meaning it helps the body adapt to stress. In the case of TB, Ginseng's adaptogenic properties may assist in supporting the body's immune system, enhancing its ability to fight against the infection. Furthermore, Ginseng has been reported to have antimicrobial effects, potentially offering an additional line of defense against the Mycobacterium tuberculosis bacterium. Despite these potential benefits, it is essential to note that Ginkgo Biloba and Ginseng supplements should not be considered as standalone treatments for TB. They should be used in conjunction with prescribed antibiotics and under the supervision of a healthcare professional.

**Ingredients:** See Supplement Facts.

**Manufacturer Country:** USA

**Product Amount:** 60 caps

**Gross Weight:** 0.25lb (133g)

**Suggested Use:** As a dietary supplement, take two (2) capsules before bedtime or as directed by your healthcare professional.

**Warning:** Keep out of reach of children. Do not use if the safety seal is damaged or missing. Store in a cool, dry place.

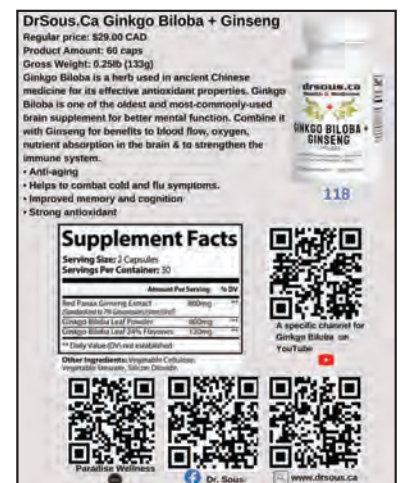

## 6) BREATHING ISSUE

Common causes of feeling short of breath are: lung problems, such as asthma and chronic obstructive pulmonary disease (COPD) heart problems, such as a cardiovascular disease and heart failure. Infections in the airways, such as croup, bronchitis, pneumonia, COVID-19, the flu and even a cold. Sometimes, mild breathing difficulty may be normal and is not a cause for concern. A very stuffy nose is one example. Strenuous exercise, especially when you do not exercise often, is another example. If breathing difficulty is new or is getting worse, it may be due to a serious problem.

### How do I know if my shortness of breath is serious?

You should also see a doctor if you notice shortness of breath becoming more severe. And if at any time your shortness of breath is accompanied by severe symptoms such as confusion, chest or jaw pain, or pain down your arm, call 911 right away.

### # Symptoms

Symptoms of breathlessness can include:

- difficulty catching your breath
- noisy breathing
- very fast, shallow breaths
- an increase in your pulse rate
- wheezing
- chest pain
- skin that looks pale and slightly blue, especially around your mouth
- cold, clammy skin
- using your shoulders and the muscles in your upper chest to help you breathe
- anxiety or panicky feelings

**Most recommended supplements for people who have difficulty in breathing are:** Elderberry & Vitamin C, Vitamin D3, & Magnesium Glycinate.

### 1. Elderberry & Vitamin C

Elderberry and Vitamin C supplements have gained popularity in recent years for their potential health benefits, especially for individuals with breathing issues. Elderberry, derived from the European elder tree, is known for its high antioxidant content and immune-boosting properties. It has been traditionally used to treat respiratory conditions such as colds, flu, and sinusitis. Elderberry supplements are rich in vitamins A, B, and C, as well as flavonoids, which have anti-inflammatory effects and may help reduce respiratory symptoms. Vitamin C, on the other hand, is a powerful antioxidant that plays a crucial role in maintaining a healthy immune system. It has been studied extensively for its potential to alleviate symptoms of respiratory conditions, including asthma and chronic obstructive pulmonary disease (COPD). Vitamin C has been shown to reduce the severity and duration of respiratory infections, enhance lung function, and decrease airway inflammation. When taken together, elderberry and Vitamin C supplements can provide a synergistic effect in supporting respiratory health. They may help strengthen the immune system, reduce inflammation in the airways, and alleviate symptoms associated with breathing issues. However, it is important to note that these supplements should not be used as a substitute for medical treatment. If you have a respiratory condition, it is always recommended to consult with a healthcare professional before starting any new supplement regimen.

**Ingredients:** see Supplement Facts.

**Flavor:** Elderberry

**Manufacturer Country:** USA

**Product Amount:** 60 gummies

**Gross Weight:** 0.56lb (255g)





### 3. Magnesium Glycinate

Magnesium Glycinate supplements have gained recognition as a potential solution for individuals suffering from breathing issues. Breathing problems, such as asthma or chronic obstructive pulmonary disease (COPD), can severely impact a person's quality of life. Magnesium, an essential mineral involved in various bodily functions, has been found to play a crucial role in respiratory health. Magnesium Glycinate, a highly bioavailable form of magnesium, offers numerous benefits for those with breathing difficulties. Firstly, this supplement acts as a bronchodilator, helping to relax the smooth muscles in the airways and promoting easier breathing. By reducing bronchoconstriction, it can alleviate symptoms like wheezing, shortness of breath, and coughing. Additionally, Magnesium Glycinate possesses anti-inflammatory properties, which can help reduce airway inflammation, a common feature of respiratory conditions. This supplement also aids in reducing oxidative stress within the airways, thereby reducing airway hyperresponsiveness. Moreover, Magnesium Glycinate has a calming effect on the nervous system, which can be beneficial for individuals with respiratory conditions exacerbated by stress or anxiety. It helps regulate the autonomic nervous system, promoting relaxation and reducing the likelihood of triggering breathing difficulties. However, it is essential to consult with a healthcare professional before incorporating Magnesium Glycinate supplements into your routine, as they can interact with certain medications or have adverse effects in certain individuals. Overall, Magnesium Glycinate supplements show promise as a natural and effective adjunct therapy for people with breathing issues, offering potential relief and improved respiratory function.



### 7) EMPHYSEMA

Emphysema is a serious and chronic lung condition in which the air sacs in the lung become weak. They lose their ability to contract after expanding and thus air gets stuck in the lungs. Eventually, they can burst, and this can make it difficult for you to get enough oxygen into the body. The most common cause of emphysema is from smoking. Up to 80% of all cases of emphysema are a result of long-term smoking of either cigarettes or other substances. Second-hand smoke, pollution, and industrial chemical fumes can also contribute to emphysema. It's also possible to get it through a hereditary genetic deficiency. Once you get emphysema, it can't be reversed because the air sacs can't be repaired. This means that the best way to deal with the condition is to avoid getting it in the first place. That means avoiding smoking, breathing clean air when possible (if these means getting a filtration device, then do so!) and making sure not to inhale second-hand smoke or chemical vapors. Emphysema generally occurs in stages with various symptoms. In this article, we're going to outline the most common symptoms of emphysema so you can decide whether or not you've got the condition and seek medical help if you deem it necessary.

#### # Symptoms

It's important to note that many people who are developing emphysema may not experience any symptoms at all. Oftentimes symptoms will not be experienced until more than 50% of the air sacs in their lungs have received irreversible damage. If you're a heavy smoker, remember that just because you're not experiencing shortness of breath or other breathing problems doesn't mean that you're safe from emphysema. The problem can creep up on you, and once it does, it's too late. Coughing is one of the earlier symptoms that appears when someone is beginning to develop emphysema. This is a similar cough to that which smokers have, often referred to aptly as a

smoker's cough. The main difference here is that the cough coming from emphysema will not disappear if you stop smoking. If you are smoking so much that you are experiencing a chronic cough, then it's a wise idea to cut back or stop before that cough becomes permanent.

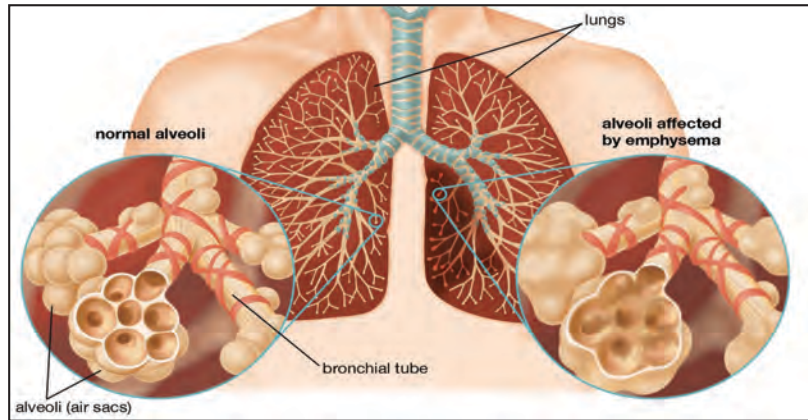

**The most recommended supplements for Emphysema are:** Vitamin D3, Magnesium Glycinate, & CoQ10.

### 1. Vitamin D3

Vitamin D3 has gained significant attention in recent years for its potential benefits in managing chronic obstructive pulmonary disease. Emphysema COPD is a progressive lung disease characterized by airflow limitation, inflammation, and oxidative stress. Research suggests that vitamin D3 may play a crucial role in improving lung function and reducing the severity of COPD symptoms. Vitamin D3 is known to have anti-inflammatory properties, which can help reduce the inflammation in the airways and lungs that occurs in COPD. It also has immunomodulatory effects, meaning it can regulate the immune response and potentially decrease the frequency and severity of exacerbations in COPD patients. Moreover, vitamin D3 is involved in calcium and phosphorus metabolism, which are essential for maintaining bone health. COPD patients often experience bone loss and osteoporosis due to systemic inflammation and the use of corticosteroids, making vitamin D3 supplementation even more important. Additionally, studies have shown that vitamin D deficiency is prevalent in COPD patients, suggesting a potential link between low vitamin D levels and the development and progression of the disease. Supplementation with vitamin D3 has been found to improve lung function, reduce systemic inflammation, and enhance exercise performance in COPD patients.

**Ingredients:** see Supplement Facts.

**Manufacturer Country:** USA

**Product Amount:** 100 soft-gels

**Gross Weight:** 0.1lb (45g)

**Suggested Use:** As a dietary supplement, adults take one (1) softgel capsule daily or as directed by a health care professional. Store in a cool, dry place and away from direct light.

**Warning:** Keep out of reach of children. Do not use if the safety seal is damaged or missing. Store in a cool, dry place.

An advertisement for DRSOUS.CA Vitamin D3. At the top, it states 'DRSOUS.CA Vitamin D3 helps maintain bone density, strength and healthy cell growth'. Below this is a paragraph explaining the benefits of Vitamin D3: 'Vitamin D3 is a fat-soluble vitamin that supports the growth and development of bones and teeth. It also plays an essential role in the functioning of the muscles and boosting energy levels in the body. The body naturally produces Vitamin D when exposed to sunlight, and you can also receive Vitamin D from some foods like oily fish. In the winter months, especially in colder regions, the body doesn't produce as much Vitamin D, which can lead to what's called 'seasonal depression.''. The advertisement features a white bottle of 'VITAMIN D3' capsules. To the right of the bottle are two QR codes. Below the QR codes, it says 'A specific channel for Supplements on YouTube' and 'Dr. Sout'. At the bottom left of the ad, the number '154' is visible. Social media icons for Facebook and YouTube are also present.

## 2. Magnesium Glycinate

Magnesium is an essential mineral that plays a vital role in various physiological processes, including muscle function, nerve transmission, and immune system regulation. Research suggests that magnesium deficiency is prevalent among COPD patients and may contribute to the progression of the disease. Magnesium Glycinate, a highly bioavailable form of magnesium, has shown promising results in managing COPD symptoms and improving lung function. This compound has been found to have anti-inflammatory properties, which can help alleviate airway inflammation and reduce the frequency and severity of exacerbations in COPD patients. Furthermore, magnesium glycinate has been shown to enhance lung function by relaxing the smooth muscles surrounding the airways, thereby improving airflow and reducing respiratory distress. It also acts as a bronchodilator, which can help open up the airways and facilitate better breathing. Additionally, magnesium glycinate may aid in reducing oxidative stress and improving immune function, both of which are crucial for COPD management.



## 3. CoQ10

Coenzyme Q10, commonly known as CoQ10, has gained attention as a potential supplement for individuals suffering from chronic obstructive pulmonary disease (COPD). COPD is a progressive lung disease that causes breathing difficulties and reduced airflow. It has been observed that individuals with COPD often have lower levels of CoQ10 in their blood, leading to speculation about the role CoQ10 may play in managing this condition. CoQ10 is an antioxidant that is naturally produced in the body and is involved in the production of energy within cells. It is also known for its ability to protect against oxidative stress, which is a major contributor to the development and progression of COPD. Research studies have shown that supplementing with CoQ10 may help improve lung function, reduce inflammation, and enhance exercise tolerance in individuals with COPD. Additionally, CoQ10 has been found to have a positive impact on the immune system, which is crucial for individuals with COPD as they are more susceptible to infections and respiratory complications.

**Ingredients:** see Supplement Facts.

**Manufacturer Country:** USA

**Product Amount:** 30 caps

**Gross Weight:** 0.25lb (113g)

**Suggested Use:** Take one (1) capsule twice a day as a dietary supplement. For best results, take 20-30 min before a meal or as directed by your healthcare professional.

**Caution:** Do not exceed recommended dose. Pregnant or nursing mothers, children under the age of 18, and individuals with a known medical condition should consult a physician before using this or any dietary supplement.

**Warning:** Keep out of reach of children. Do not use if the safety seal is damaged or missing. Store in a cool, dry place.



## 8) BRONCHITIS

Bronchitis is an inflammation of the bronchial tubes that carry air into the lungs. The inflammation leads to a persistent cough that can go on for weeks or longer. The cough may be wet as mucus production increases as a result of the inflammation. Bronchitis usually develops after a bout of common cold. It can cause chest pain, breathing difficulty, and wheezing. Other symptoms of bronchitis include fever, sore throat, runny nose, fatigue, and body aches. Bronchitis is one of the leading reasons for adults to visit doctors. Although many patients think that antibiotics will help them, in many cases, they don't because the condition is usually a result of a viral infection. Antibiotics are helpful in treating bacterial infections, but not inflammatory conditions like bronchitis. You can help your body to recover from the condition using natural treatments, including the following 10 home remedies for bronchitis.

### # Symptoms

#### Coughing Spells

Coughing is a predominant symptom of bronchitis. Though short and weak, the cough usually occurs repeatedly. Many people assume they just have "a cough" and do not seek treatment for bronchitis initially. In most cases, bronchitis goes away naturally, and doctors prescribe rest, fluids, and mild cough medicine.

#### Phlegm

Often, phlegm production accompanies the hacking cough, with the former beginning 24 to 48 hours after the onset of the latter. Phlegm may be white, yellow, or green, though in severe cases, the expectoration could be streaked with blood. This should prompt the individual to seek immediate medical attention, as it could indicate tuberculosis or another serious condition. In most cases, a cough with phlegm eases discomfort and pain by lubricating the airway. A dry cough often calls for cough suppressants to prevent disruption of sleep.

#### Chest Discomfort

Chronic bronchitis often causes discomfort in the chest. Some experience constriction and heaviness, while others feel pain below the breastbone when taking deep breaths. In cases of acute bronchitis, doctors usually recommend anti-inflammatory painkillers. Long-term pain relief and other prescriptions may be administered to people with chronic bronchitis.

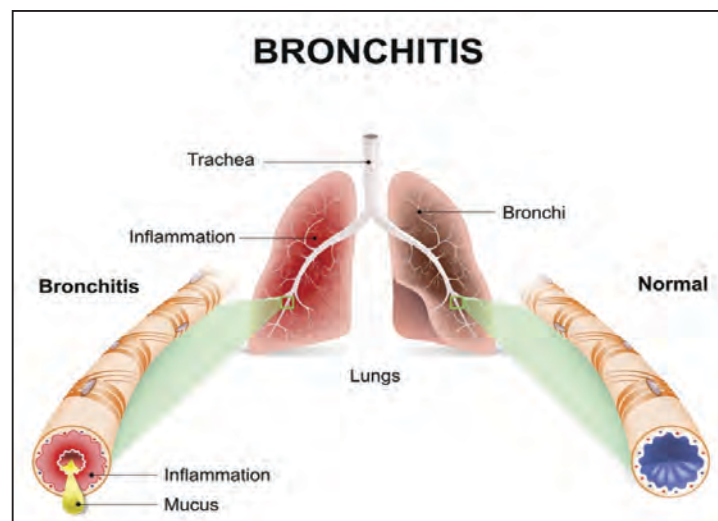

**The most recommended supplements for are chronic bronchitis:** Vitamin D3, Magnesium Glycinate, & CoQ10.

### 1. Vitamin D3

Vitamin D3 has gained significant attention in recent years for its potential benefits in managing chronic obstructive pulmonary disease. Emphysema COPD is a progressive lung disease characterized by airflow limitation, inflammation, and oxidative stress. Research suggests that vitamin D3 may play a crucial role in improving lung function and reducing the severity of COPD symptoms. Vitamin

D3 is known to have anti-inflammatory properties, which can help reduce the inflammation in the airways and lungs that occurs in COPD. It also has immunomodulatory effects, meaning it can regulate the immune response and potentially decrease the frequency and severity of exacerbations in COPD patients. Moreover, vitamin D3 is involved in calcium and phosphorus metabolism, which are essential for maintaining bone health. COPD patients often experience bone loss and osteoporosis due to systemic inflammation and the use of corticosteroids, making vitamin D3 supplementation even more important. Additionally, studies have shown that vitamin D deficiency is prevalent in COPD patients, suggesting a potential link between low vitamin D levels and the development and progression of the disease. Supplementation with vitamin D3 has been found to improve lung function, reduce systemic inflammation, and enhance exercise performance in COPD patients.

**Ingredients:** see Supplement Facts.

**Manufacturer Country:** USA

**Product Amount:** 100 soft-gels

**Gross Weight:** 0.1lb (45g)

**Suggested Use:** As a dietary supplement, adults take one (1) softgel capsule daily or as directed by a health care professional. Store in a cool, dry place and away from direct light.

**Warning:** Keep out of reach of children. Do not use if the safety seal is damaged or missing. Store in a cool, dry place.



## 2. Magnesium Glycinate

Magnesium is an essential mineral that plays a vital role in various physiological processes, including muscle function, nerve transmission, and immune system regulation. Research suggests that magnesium deficiency is prevalent among COPD patients and may contribute to the progression of the disease. Magnesium Glycinate, a highly bioavailable form of magnesium, has shown promising results in managing COPD symptoms and improving lung function. This compound has been found to have anti-inflammatory properties, which can help alleviate airway inflammation and reduce the frequency and severity of exacerbations in COPD patients. Furthermore, magnesium glycinate has been shown to enhance lung function by relaxing the smooth muscles surrounding the airways, thereby improving airflow and reducing respiratory distress. It also acts as a bronchodilator, which can help open up the airways and facilitate better breathing. Additionally, magnesium glycinate may aid in reducing oxidative stress and improving immune function, both of which are crucial for COPD management.



### 3. CoQ10

Coenzyme Q10, commonly known as CoQ10, has gained attention as a potential supplement for individuals suffering from chronic obstructive pulmonary disease (COPD). COPD is a progressive lung disease that causes breathing difficulties and reduced airflow. It has been observed that individuals with COPD often have lower levels of CoQ10 in their blood, leading to speculation about the role CoQ10 may play in managing this condition. CoQ10 is an antioxidant that is naturally produced in the body and is involved in the production of energy within cells. It is also known for its ability to protect against oxidative stress, which is a major contributor to the development and progression of COPD. Research studies have shown that supplementing with CoQ10 may help improve lung function, reduce inflammation, and enhance exercise tolerance in individuals with COPD. Additionally, CoQ10 has been found to have a positive impact on the immune system, which is crucial for individuals with COPD as they are more susceptible to infections and respiratory complications.

**Ingredients:** see Supplement Facts.

**Manufacturer Country:** USA

**Product Amount:** 30 caps

**Gross Weight:** 0.25lb (113g)

**Suggested Use:** Take one (1) capsule twice a day as a dietary supplement. For best results, take 20-30 min before a meal or as directed by your healthcare professional.

**Caution:** Do not exceed recommended dose. Pregnant or nursing mothers, children under the age of 18, and individuals with a known medical condition should consult a physician before using this or any dietary supplement.

**Warning:** Keep out of reach of children. Do not use if the safety seal is damaged or missing. Store in a cool, dry place.



### 9) SINUSITIS

Sinusitis is an inflammation, or swelling, of the tissue lining your sinuses. Sinuses are structures inside your face that are normally filled with air. Bacterial infections, viral infections and allergies can irritate them, causing them to get blocked and filled with fluid.

**How can I clear my sinusitis?**

**These self-help steps can help relieve sinusitis symptoms:**

1. Rest. This will help your body fight infection and speed recovery.
2. Drink fluids. Continue to drink plenty of fluids.
3. Use a warm compress. ...
4. Moisten your sinus cavities. ...
5. Rinse your nasal passages.

## # Symptoms

### 1. Facial Pain and Pressure

Sinuses are cavities behind the forehead, nasal bones, cheeks, and eyes. Their main purpose is to warm, moisten, and filter the air we breathe in before it goes to the lungs. Because they're hollow, they also lighten the weight of the head. If the passage connecting the sinuses to the nasal passages becomes plugged, the sinus can no longer drain properly; they accumulate mucus, resulting in a feeling of heaviness in the face and pain from increased pressure on the nerves. The facial pain and pressure may worsen when bending over.

### 2. A Constant Headache

Swelling and pressure in the face from clogged sinuses can cause a headache. The blockage and inflammation make the person unconsciously tighten the muscles around the forehead and the top of the head -- similar to what happens during a tension headache. The pain usually worsens in the morning because fluids have built up during the night due to the recumbent position of the head. Changes of temperature or rapid changes in head orientation can also exacerbate headaches.

### 3. Bad Breath

Halitosis, which develops when discharge that collects in the sinuses and nose drips into the back of the throat, causes bad breath that brushing and mouthwash will not alleviate. Bad breath usually occurs because the air mixes with the odor from the infection. This reason for halitosis has nothing to do with oral health and should pass once the infection is gone.

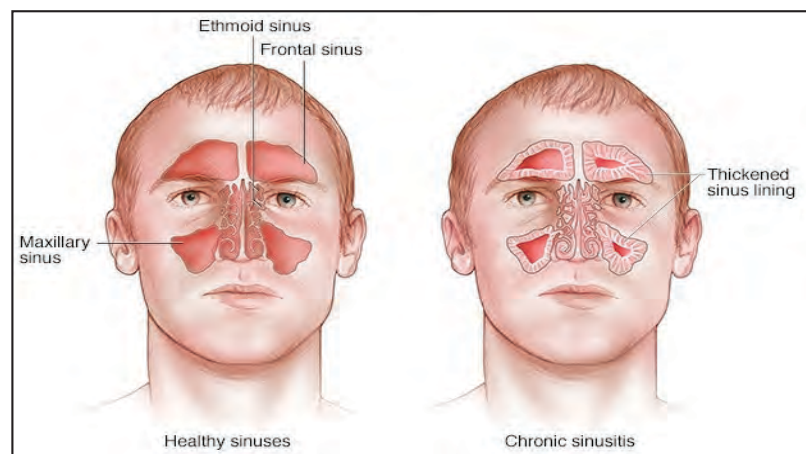

**Most recommended supplements for sinusitis are:** Platinum Turmeric, Probiotic 40, & Elderberry & Vitamin C.

### 1. Platinum Turmeric

Platinum Turmeric supplement for sinusitis is a highly effective natural remedy that offers relief and support for individuals suffering from sinusitis. Sinusitis, a condition characterized by inflammation of the sinus cavities, can cause symptoms such as facial pain, nasal congestion, headaches, and difficulty breathing. The Platinum Turmeric supplement harnesses the power of turmeric, a potent herb known for its anti-inflammatory and antioxidant properties. Turmeric contains a compound called curcumin, which has been extensively studied for its therapeutic potential in various health conditions, including sinusitis. By incorporating turmeric into a convenient supplement form, Platinum Turmeric provides a convenient and accessible way for individuals to benefit from its healing properties. The anti-inflammatory effects of curcumin can help reduce the inflammation and swelling of the sinus cavities, thereby alleviating symptoms associated with sinusitis. Additionally, curcumin's antioxidant properties can help strengthen the immune system, promoting a faster recovery from sinusitis and preventing recurrent infections. Platinum Turmeric's high-quality formulation ensures optimal absorption of curcumin, maximizing its therapeutic benefits. With its natural and safe approach to sinusitis relief, Platinum Turmeric supplement offers a promising alternative to conventional medications, which often come with unwanted side effects. Incorporating this supplement into a daily wellness routine can provide individuals with long-term relief from sinusitis symptoms, improving their overall quality of life.

**Ingredients:** see Supplement Facts.

**Manufacturer Country:** USA

**Product Amount:** 60 caps

**Gross Weight:** 0.25lb (113g)

**Suggested Use:** Take two (2) capsules once a day as a dietary supplement. For best results, take 20-30 min before a meal or as directed by your healthcare professional.

**Caution:** Consult a physician before use if you have any medical conditions. Glucosamine is derived from shellfish. People allergic to shellfish should not consume this product.

**Warning:** Keep out of reach of children. Do not use if the safety seal is damaged or missing. Store in a cool, dry place.



## 2. Probiotics

The traditional approach to treating sinusitis involves the use of antibiotics and decongestants, but these methods often come with side effects and may not address the root cause of the problem. Probiotics, on the other hand, are living microorganisms that can provide a range of health benefits when consumed in adequate amounts. Research suggests that probiotics can help modulate the immune system, reduce inflammation, and promote a healthy balance of bacteria in the sinuses. By introducing beneficial bacteria into the nasal passages, probiotics can help restore the natural microbial balance, which may alleviate symptoms and support the body's ability to fight off infections.

**Ingredients:** See Supplement Facts.

**Manufacturer Country:** USA

**Product Amount:** 60 caps

**Gross Weight:** 0.25lb (113g)

**Suggested Use:** Take two (2) capsules once a day as a dietary supplement. For best results, take one (1) capsule during the day and one (1) capsule in the evening. Repeat the process daily. Do not exceed two capsules per day.

**Warning:** Keep out of reach of children. Do not use if the safety seal is damaged or missing. Store in a cool, dry place.

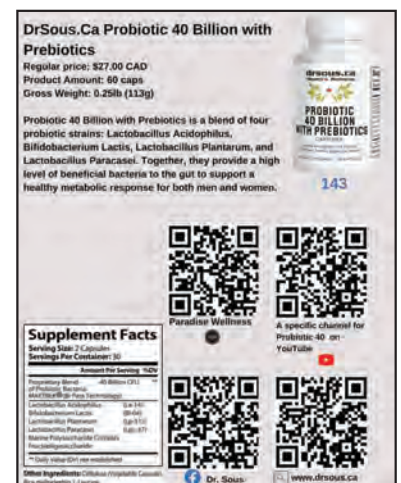



### 3. Elderberry & Vitamin C

Elderberry and Vitamin C supplements have gained significant attention in recent years for their potential benefits in managing sinusitis, a common condition characterized by inflammation of the sinuses. Sinusitis can cause a range of uncomfortable symptoms such as facial pain, nasal congestion, and headaches, making it crucial to find effective ways to alleviate these issues. Elderberry, derived from the elder plant, is rich in antioxidants and has been traditionally used for its immune-boosting properties. It contains flavonoids, which have anti-inflammatory effects and may help reduce sinus inflammation. Vitamin C, on the other hand, is well-known for its immune-enhancing properties and its ability to fight off infections. It plays a crucial role in supporting the health of the mucous membranes in the sinuses and respiratory system. By combining these two powerful ingredients in a supplement, individuals suffering from sinusitis may experience potential benefits in terms of reducing inflammation, boosting the immune system, and promoting sinus health. However, it is important to note that while elderberry and vitamin C supplements may offer potential relief for sinusitis symptoms, they should not be seen as a substitute for medical advice or prescribed treatments.

**Ingredients:** see Supplement Facts.

**Flavor:** Elderberry

**Manufacturer Country:** USA

**Product Amount:** 60 gummies

**Gross Weight:** 0.56lb (255g)

**Suggested Use:** Take two (2) gummies once a day as a dietary supplement.

**Caution:** Do not exceed recommended dose. Pregnant or nursing women, children under 18, and individuals with known medical conditions should consult their physician before taking.

**Warning:** Keep out of reach of children. Do not use if the safety seal is damaged or missing. Store in a cool, dry place.

**DRSOUS.CA Elderberry & Vitamin C Gummies**

Regular price: \$25.00 CAD  
Product Amount: 60 gummies  
Gross Weight: 0.56lb (255g)  
Packed with immune-boosting nutrients, including Vitamin C, Zinc, and Elderberry, this gummy is a popular way to receive antioxidants and boost overall health.

- Immune boosting
- Overall health
- Eases cold and flu symptoms
- Improves iron absorption

**Supplement Facts**

Amount Per Serving	% Daily Value*
60 Gummies	
Vitamin C (Ascorbic Acid)	100%
Zinc (Zinc Oxide)	100%
Elderberry (Sambucus nigra)	100%
Other Ingredients: Gelatin, Sugar, Natural Flavors, Citric Acid, Stevia Leaf Extract, and Natural Fruit Flavors.	

\*Percent Daily Values are based on a diet of other people's secrets.

Paradise Wellness A specific channel for Elderberry & Vitamin C on YouTube

Dr. Sous www.drsous.ca

### 10) COMMON COLD

A cold is an upper respiratory tract infection caused by a virus. The effects of the virus often take a few days to appear. There is no cure, but the symptoms are easy to treat and usually subside in a week or so. Cold remedies usually fall into two different categories: over-the-counter medications and home remedies. Decongestants, pain relievers, and anti-histamines are common OTC remedies. Home remedies are often very effective in treating a common cold. They are inexpensive and have minimal side effects.

#### # Symptoms

A stuffy nose is prevalent when you have a cold. Excess fluid causes mucous membranes and blood vessels to swell. You only need to worry if the mucus becomes thick and yellowy green in color. If it lasts too long and you develop sinus pain or a severe headache, you may need to see a doctor. Many methods are available for treating nasal congestion. Saline drops are available over-the-counter, and you don't need a prescription. They cause blood vessels in the nose to contract, reducing swelling. You can use a neti pot to flush a

saline solution through your nasal passages. It thins, loosens and rinses away mucus. Using a vapor rub can also deal with congestion. It opens up the airways and breaks down mucus. Elevating your head can decrease the flow of blood to the nose and relieve congestion too. Taking a hot, steamy shower can also help. When a cold virus enters the body, it releases inflammatory mediators like histamine. This causes mucus glands to secrete fluid and blood vessels to dilate. The irritation of the mucous membranes of the nose and throat cause sneezing.

There is not much you can do to prevent sneezing. When your other symptoms go, your sneezing will stop too. You can treat sneezing with antihistamines. Over-the-counter medications for colds often contain antihistamines.

Coughing can go with a cold. It is usually a wet or a productive cough that expels phlegm.

This cough can take some time to go away, but it is not usually a cause for concern. If a cough comes with a fever and thick, greenish mucus, it's time to visit a doctor.

Cough syrups are readily available over-the-counter. The expectorant in a cough syrup loosens mucus, increases its water content and thins it out. You can make your own natural expectorant if you prefer. A teaspoon of dried licorice root with a honey and lemon drink will help. A peppermint tea contains menthol which also helps to thin mucus. Eucalyptus is another used natural expectorant and decongestant.

SIGNS AND SYMPTOMS	COLD	FLU
Symptom onset	Gradual	Abrupt
Fever	Rare	Usual
Aches	Slight	Usual
Chills	Uncommon	Fairly common
Fatigue, weakness	Sometimes	Usual
Sneezing	Common	Sometimes
Chest discomfort, cough	Mild to moderate	Common
Stuffy nose	Common	Sometimes
Sore throat	Common	Sometimes
Headache	Rare	Common

#FIGHT FLU

**Most commonly recommended supplements for common cold are:** Elderberry & Vitamin C, Vitamin D3, & Probiotic 40.

### 1. Elderberry & Vitamin C

Elderberry and Vitamin C have gained popularity as natural remedies for the common cold. Elderberry, derived from the European elder tree, has long been used in traditional medicine for its immune-boosting properties. It is rich in antioxidants that help to fight off free radicals and reduce inflammation in the body. Elderberry also contains anthocyanins, which are believed to have antiviral properties that can inhibit the replication of viruses, including those responsible for causing the common cold. Additionally, elderberry has been found to stimulate the production of cytokines, which are important in regulating the immune response. Vitamin C, on the other hand, is well-known for its immune-enhancing benefits. It plays a crucial role in supporting the function of various immune cells, such as neutrophils and lymphocytes, which are responsible for fighting off infections. Vitamin C also acts as an antioxidant, protecting cells

from damage caused by harmful molecules. When it comes to the common cold, taking elderberry and vitamin C together may provide a synergistic effect in boosting the immune system and reducing the severity and duration of symptoms. While more research is needed to fully understand the efficacy of these natural remedies, many individuals have reported positive outcomes in terms of symptom relief and prevention. However, it is important to note that elderberry and vitamin C should not replace conventional medical treatment and should be used as adjuncts to a healthy lifestyle, including proper nutrition and regular exercise.

**Ingredients:** see Supplement Facts.

**Flavor:** Elderberry

**Manufacturer Country:** USA

**Product Amount:** 60 gummies

**Gross Weight:** 0.56lb (255g)

**Suggested Use:** Take two (2) gummies once a day as a dietary supplement.

**Caution:** Do not exceed recommended dose. Pregnant or nursing women, children under 18, and individuals with known medical conditions should consult their physician before taking.

**Warning:** Keep out of reach of children. Do not use if the safety seal is damaged or missing. Store in a cool, dry place.

**DRSOUS.CA Elderberry & Vitamin C Gummies**

Regular price: \$25.00 CAD  
Product Amount: 60 gummies  
Gross Weight: 0.56lb (255g)

Packed with immune-boosting nutrients, including Vitamin C, Zinc, and Elderberry, this gummy is a popular way to receive antioxidants and boost overall health.

- Immune boosting
- Overall health
- Eases cold and flu symptoms
- Improves iron absorption

**Supplement Facts**

Serving Size: 2 Gummies		Amount Per Serving	
Percent Daily Values		100%	
Vitamin C	1000mg	200%	100%
Zinc	10mg	200%	100%
Elderberry	100mg	100%	100%
Vitamin E	100IU	200%	100%
Vitamin B12	1000mcg	200%	100%
Vitamin D3	1000IU	200%	100%
Other Ingredients	Glucose Syrup, Sugar, Natural Flavors, Citric Acid, Artificial Flavors, Fruit, Vegetable Oil (Sunflower, Canola, Walnut)		

Paradise Wellness A specific channel for Elderberry & Vitamin C on YouTube

Dr. Sous www.drsous.ca

## 2. Vitamin D3

Vitamin D3, also known as the “sunshine vitamin,” has gained significant attention in recent years for its potential role in boosting the immune system and preventing the common cold. Numerous studies suggest that maintaining adequate levels of Vitamin D3 can help reduce the risk and severity of respiratory tract infections, including the common cold. Vitamin D3 is synthesized in the skin when it is exposed to sunlight, and it plays a crucial role in modulating the immune response. It has been observed that individuals with lower levels of Vitamin D3 are more susceptible to respiratory infections. The exact mechanisms by which Vitamin D3 influences the immune system are still being explored, but it is believed to enhance the production of antimicrobial peptides that help fight off invading pathogens. Furthermore, Vitamin D3 has been shown to have anti-inflammatory properties, which can help alleviate symptoms associated with the common cold, such as nasal congestion and sore throat. While Vitamin D3 supplements are readily available, it is important to note that maintaining a healthy lifestyle that includes regular sun exposure, a balanced diet, and exercise can also contribute to optimal Vitamin D3 levels.

**Ingredients:** see Supplement Facts.

**Manufacturer Country:** USA

**Product Amount:** 100 soft-gels

**Gross Weight:** 0.1lb (45g)

**Suggested Use:** As a dietary supplement, adults take one (1) softgel capsule daily or as directed by a health care professional. Store in

a cool, dry place and away from direct light.

**Warning:** Keep out of reach of children. Do not use if the safety seal is damaged or missing. Store in a cool, dry place.



### 3. Probiotics

Probiotics, which are beneficial live bacteria and yeasts, have gained significant attention in recent years for their potential role in improving overall health and combating various ailments. One area where probiotics have shown promise is in the management and prevention of the common cold. The common cold, caused by a viral infection, is a prevalent condition that affects millions of people worldwide each year. It is characterized by symptoms such as cough, sore throat, runny nose, congestion, and fatigue, leading to reduced productivity and quality of life. While there is no cure for the common cold, research suggests that probiotics may offer some relief and help strengthen the immune system. Probiotics work by restoring the balance of gut bacteria, which play a crucial role in immune function. By promoting the growth of beneficial bacteria and inhibiting the growth of harmful pathogens, probiotics help maintain a healthy gut microbiome. This, in turn, boosts the body's immune response, making it more resilient to infections, including the common cold. Several studies have investigated the use of specific strains of probiotics, such as Lactobacillus and Bifidobacterium, in reducing the severity and duration of cold symptoms.

**Ingredients:** See Supplement Facts.

**Manufacturer Country:** USA

**Product Amount:** 60 caps

**Gross Weight:** 0.25lb (113g)

**Suggested Use:** Take two (2) capsules once a day as a dietary supplement. For best results, take one (1) capsule during the day and one (1) capsule in the evening. Repeat the process daily. Do not exceed two capsules per day.

**Warning:** Keep out of reach of children. Do not use if the safety seal is damaged or missing. Store in a cool, dry place.



## 11) ALLERGIES

An allergic reaction usually happens within minutes after being exposed to an allergen, but sometimes it can take place several hours after exposure.

Symptoms and severity of a reaction can differ each time. Keep in mind that an allergic reaction can start with mild symptoms that can get worse quickly.

### # Symptoms

- **Skin:** hives, swelling (face, lips, tongue), itching, warmth, redness
- **Respiratory (breathing):** coughing, wheezing, shortness of breath, chest pain/tightness, throat tightness, hoarse voice, nasal congestion or hay fever-like symptoms (runny itchy nose and watery eyes, sneezing), trouble swallowing
- **Gastrointestinal (stomach):** nausea, pain/cramps, vomiting, diarrhea
- **Cardiovascular (heart):** paler than normal skin colour/blue colour, weak pulse, passing out, dizziness or light headedness, shock
- **Other:** anxiety, sense of doom (the feeling that something bad is about to happen), headache, uterine cramps, metallic taste

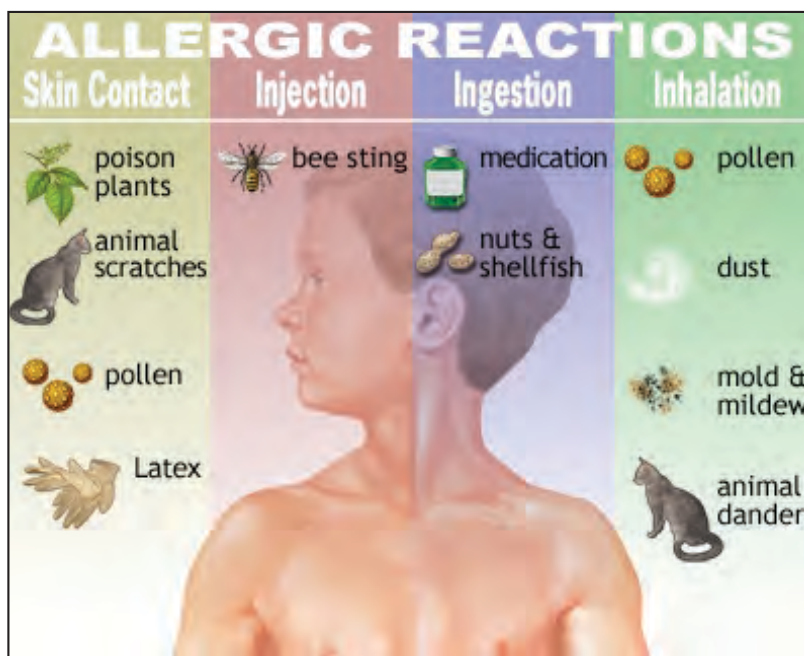

**Most recommended supplements for allergies are:** Elderberry & Vitamin C, Probiotic 40, & Platinum Turmeric.

### 1. Elderberry and Vitamin C

Elderberry and Vitamin C have gained significant attention for their potential benefits in alleviating allergies. Elderberry, derived from the European elder tree, is rich in antioxidants and has been traditionally used for centuries to boost the immune system and combat various ailments. It contains flavonoids, such as quercetin, which have anti-inflammatory properties and may help reduce allergic reactions by inhibiting the release of histamine. Histamine is a chemical produced by the body in response to an allergen, triggering symptoms like sneezing, itching, and watery eyes. By inhibiting histamine release, elderberry may help alleviate these symptoms and provide relief for individuals with allergies. Similarly, Vitamin C, also known as ascorbic acid, is a powerful antioxidant that plays a crucial role in supporting immune function. It helps to strengthen the body's natural defense mechanisms and can reduce the severity of allergic reactions. Vitamin C acts as a natural antihistamine, reducing the production of histamine and thereby relieving allergy symptoms. Additionally, it can help regulate the production of cortisol, a hormone that plays a role in the body's response to stress. Allergies can often be exacerbated by stress, so maintaining adequate levels of Vitamin C may help mitigate the impact of stress on allergic reactions. When combined, elderberry and Vitamin C can provide a synergistic effect in combating allergies. The antioxidant properties of both compounds help to neutralize free radicals and reduce inflammation, which can contribute to allergic reactions. Additionally, elderber-

ry's potential to inhibit histamine release, coupled with Vitamin C's antihistamine properties, can provide a comprehensive approach to managing allergy symptoms. It is important to note that while elderberry and Vitamin C may offer potential benefits for allergies, they should not replace conventional medical treatment. Allergies can vary in severity, and it is crucial to consult with a healthcare professional for proper diagnosis and treatment. However, incorporating elderberry and Vitamin C into a well-rounded approach to allergy management, including allergen avoidance and other recommended treatments, may provide individuals with additional support in their efforts to alleviate allergy symptoms.

**Ingredients:** see Supplement Facts.

**Flavor:** Elderberry

**Manufacturer Country:** USA

**Product Amount:** 60 gummies

**Gross Weight:** 0.56lb (255g)

**Suggested Use:** Take two (2) gummies once a day as a dietary supplement.

**Caution:** Do not exceed recommended dose. Pregnant or nursing women, children under 18, and individuals with known medical conditions should consult their physician before taking.

**Warning:** Keep out of reach of children. Do not use if the safety seal is damaged or missing. Store in a cool, dry place.

**DRSOUS.CA Elderberry & Vitamin C Gummies**

Regular price: \$25.00 CAD  
Product Amount: 60 gummies  
Gross Weight: 0.56lb (255g)

Packed with immune-boosting nutrients, including Vitamin C, Zinc, and Elderberry, this gummy is a popular way to receive antioxidants and boost overall health.

- Immune boosting
- Overall health
- Eases cold and flu symptoms
- Improves iron absorption

**Supplement Facts**

	Amount Per Serving	% Daily Value
Serving Size: 2 Gummies		
Amount Per Serving		
Elderberry	100mg	20%
Vitamin C	100mg	20%
Zinc	10mg	20%
Other Ingredients	100mg	20%
Total Weight	255g	100%

This product's Daily Values are based on a diet of 2000 calories per day. Actual values may vary. Please consult your physician for more information.

Paradise Wellness A specific channel for Elderberry & Vitamin C on YouTube

Dr. Sous www.drsous.ca

## 2. Probiotics

Probiotics have gained significant attention in recent years, not just for their potential benefits in promoting gut health, but also for their promising role in managing allergies. Allergies, which occur when the immune system overreacts to harmless substances, can cause a range of unpleasant symptoms and affect one's quality of life. Traditional treatments often focus on alleviating symptoms rather than addressing the root cause, which has led researchers to explore alternative approaches. Probiotics, live microorganisms that confer health benefits when consumed, have emerged as a potential natural intervention for allergies. These beneficial bacteria are believed to modulate the immune system and promote a healthy balance of gut flora, which may help reduce allergic reactions. Several studies have shown promising results, suggesting that certain strains of probiotics can alleviate symptoms and improve the overall well-being of individuals with allergies. For instance, research has indicated that specific strains, such as *Lactobacillus rhamnosus* and *Bifidobacterium lactis*, may help reduce the severity of allergic rhinitis, a common allergic condition characterized by nasal congestion, sneezing, and itchy eyes. Furthermore, probiotics have shown potential in preventing the development of allergies in infants and young children, particularly those at high risk due to a family history of allergic diseases. While the exact mechanisms by which probiotics exert their effects on allergies are still being investigated, it is believed that they modulate the immune system by promoting the production of anti-inflammatory compounds and enhancing the integrity of the gut barrier. Additionally, individual responses to probiotic supplementation may vary, highlighting the importance of personalized approaches and consulting healthcare professionals before starting any new treatment regimen.

**Ingredients:** See Supplement Facts.

**Manufacturer Country:** USA

**Product Amount:** 60 caps

**Gross Weight:** 0.25lb (113g)

**Suggested Use:** Take two (2) capsules once a day as a dietary supplement. For best results, take one (1) capsule during the day and one (1) capsule in the evening. Repeat the process daily. Do not exceed two capsules per day.

**Warning:** Keep out of reach of children. Do not use if the safety seal is damaged or missing. Store in a cool, dry place.



### 3. Platinum Turmeric

Platinum Turmeric has been gaining attention in recent years for its potential benefits in managing allergies. Turmeric, a vibrant yellow spice commonly used in traditional medicine, has long been recognized for its anti-inflammatory properties. The active compound in turmeric, called curcumin, has been shown to inhibit the release of histamine, a key player in allergic reactions. Histamine is responsible for triggering symptoms such as sneezing, itching, and congestion. By reducing histamine levels, Platinum Turmeric may help alleviate these symptoms and provide relief to individuals suffering from allergies. Furthermore, curcumin has been found to modulate the immune system by suppressing the activation of immune cells involved in allergic responses. This modulation may help to prevent excessive immune reactions and reduce the severity of allergic symptoms. Platinum Turmeric's potential as a natural remedy for allergies extends beyond its anti-inflammatory and immune-modulating properties. Studies have suggested that curcumin may also possess antioxidant effects, which could contribute to the protection of cells from oxidative damage caused by allergens. Additionally, Platinum Turmeric has been found to inhibit the release of certain enzymes that are involved in the production of pro-inflammatory molecules. Through these mechanisms, Platinum Turmeric may help to mitigate the inflammatory processes that underlie allergic reactions.

**Ingredients:** see Supplement Facts.

**Manufacturer Country:** USA

**Product Amount:** 60 caps

**Gross Weight:** 0.25lb (113g)

**Suggested Use:** Take two (2) capsules once a day as a dietary supplement. For best results, take 20-30 min before a meal or as directed by your healthcare professional.

**Caution:** Consult a physician before use if you have any medical conditions. Glucosamine is derived from shellfish. People allergic to shellfish should not consume this product.

**Warning:** Keep out of reach of children. Do not use if the safety seal is damaged or missing. Store in a cool, dry place.



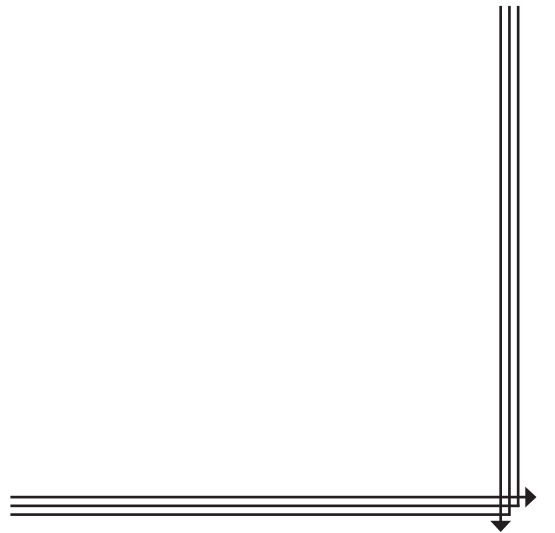
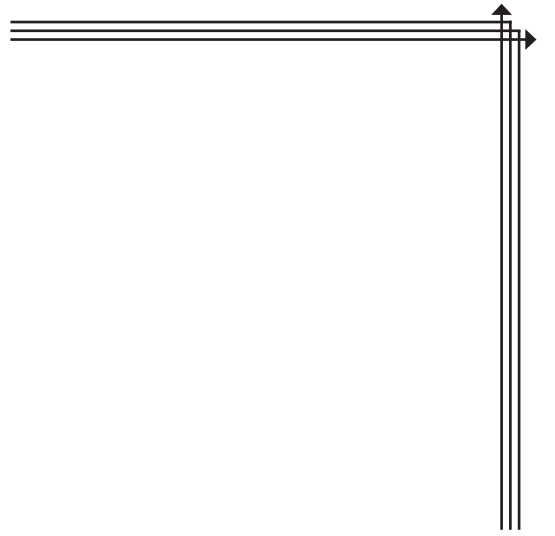



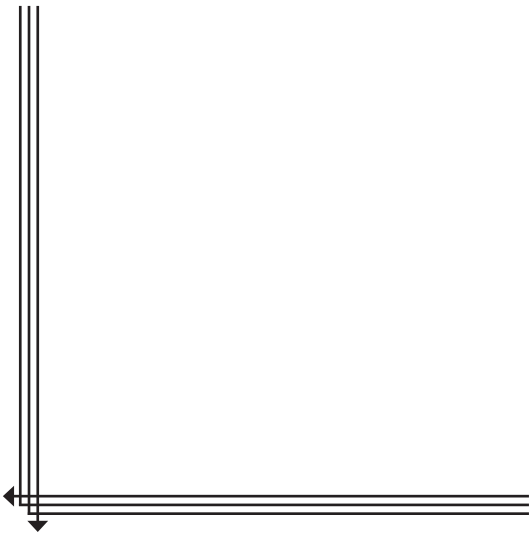
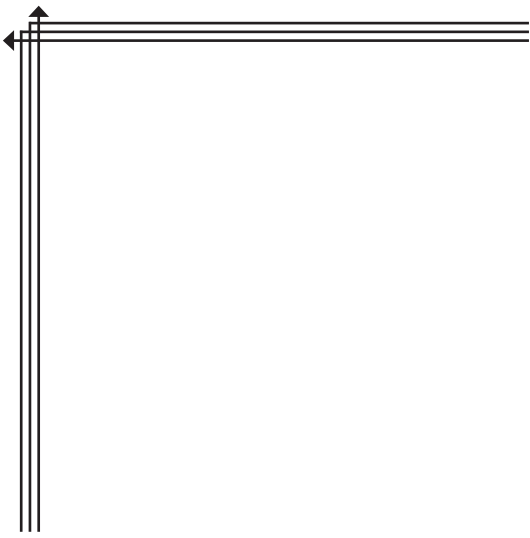

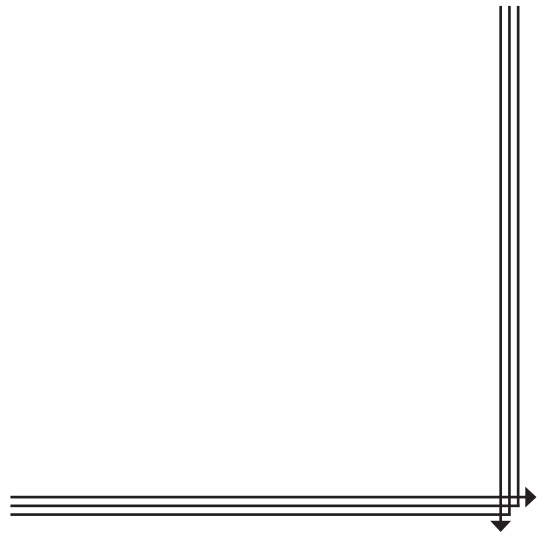
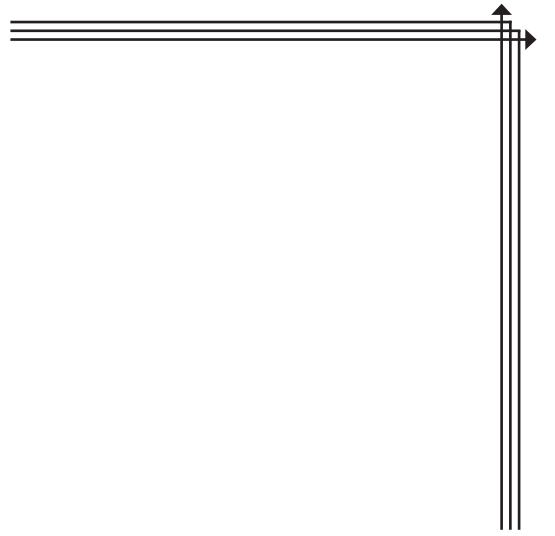

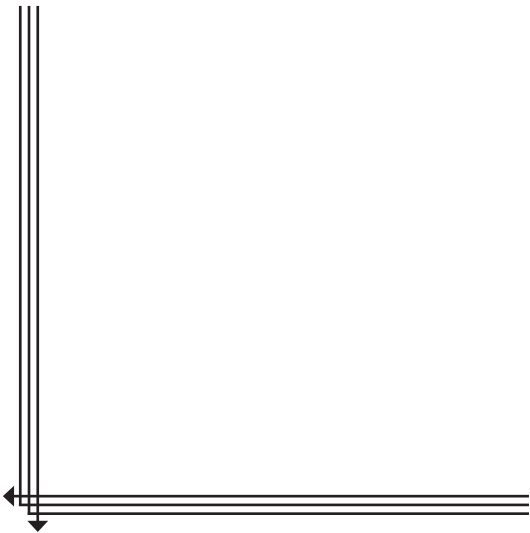
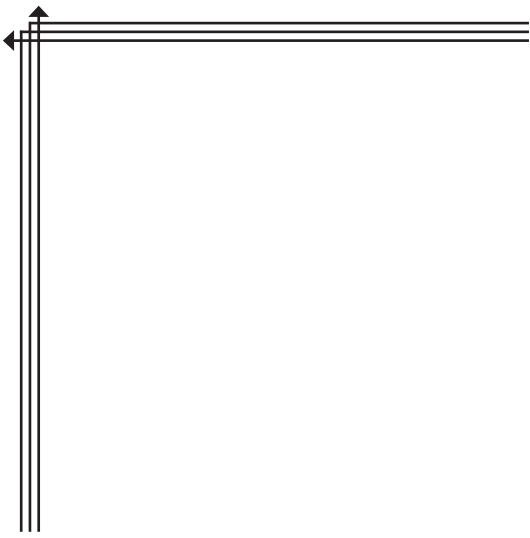

## Dr. Mahmoud Sous – Ph.D.

During the period of 1995-1999, I went to the medical school in Poland to research about the various methods of back pain treatment. After finishing my PhD, I took variety of courses including naturopath, acupuncture, and manual techniques. This gave me an idea that exercises, and massage could be helpful in treatment of chronic pain. But my findings didn't stop me here, I also worked as a naturopath practitioner in Canada where I got familiar about treatments with Chinese medicines, osteopath techniques and some other manual therapies which helps in pain management.

Fixing injuries requires an understanding of anatomy and biomechanics. That is why my research and treatment belong to the holistic approach of using different techniques and remedies for the treatment of back pain. In 1990, I realize that there are some complex spinal aspects and issues which leads to of back pain. So, from my case studies I formulated a guideline which is clear and easy to understand and will fix your issues.

My goal is to help people visualize how the body functions and what happens inside when you experience pain. Healing requires to focus on one's action because pain results due to faulty actions and movements. This thought motivated me to work on a book which will include all home remedies where people can treat themselves to fix their pain. I have included knowledge based on my clinical research using manual massage therapy, food habits, nutrition facts, heat, sauna, hydrotherapy, cold water treatments which overall helps in pain management. It gives me pleasure to introduce this book to the community where I have shared all my experienced treatment plans.



## Priyanka Yadav (Physiotherapist)

I started my career in 2011, since then I have worked as a Physiotherapist in several clinics and hospitals in India. Working mostly in the Outpatient department made me realize that Physio's role is extremely crucial in the rehabilitation and recovery process of a patient. My desire to reach out to more people motivated me to work for this book. Have worked with Dr. Mahmoud on several research books on self-pain management. We have been constantly working on curating the best suited protocol for various Musculoskeletal conditions. Additionally, we have also included approaches with alternative medicine.

ISBN 978-1-998900-26-8

